

	Company Profile, Business Fields			2
<b>1</b>	<b>Mobile Radio Measurements</b>			<b>5</b>
	Analog Radiocommunication Testers Mobile Station Testers, Base Station Testers DECT Tester, CDMA Tester, <i>Bluetooth</i> Tester	Mobile Station Radio Test Sets Base Station Radio Test Sets Analysis and Simulation Software	Digital Radiocommunication Test Sets Mobile Installation Tester Shielded Chambers, Antenna Coupler	
<b>2</b>	<b>EMC/Field-Strength Measurements</b>			<b>55</b>
	Standards Test Receivers, Test Software	Artificial Mains Networks Attenuators, Highpass	Absorbing Clamp Slideway Antennas, Probes, Absorbing Clamps	
<b>3</b>	<b>TV Broadcast Measurements</b>			<b>109</b>
	Generators, Analyzers, Test Software	Test Transmitters, Test Receivers	Measurement Demodulators, Decoders	
<b>4</b>	<b>Spectrum and Network Analysis</b>			<b>170</b>
	Spectrum and Network Analyzers	Scalar Network Analyzers Antenna Measurement Set	Vector Network Analyzers VSWR Bridges	
<b>5</b>	<b>Signal Generation</b>			<b>225</b>
	RF Signal Generators Microwave Signal Generators	Function, Vector and ARB Generators Fading Simulator	Receiver Test Source Software for Simulation of I/Q Signals	
<b>6</b>	<b>Signal Analysis</b>			<b>271</b>
	Audio Analyzers, Test System for Hearing Aids	VOR/ILS Receiver/Analyzer	Modulation Analyzers	
<b>7</b>	<b>Voltage, Power, Frequency Measurements</b>			<b>288</b>
	RF Millivoltmeters, Level Meters Voltage Probes, Power Sensors	Terminating Power Meters Directional Power Meters	Broadband Voltmeters, Multimeters Universal Counters	
<b>8</b>	<b>Test Systems</b>			<b>315</b>
	Production Test Systems Mobile Radio Test Systems	Coverage Measurement Systems	EMC Test Systems	
<b>9</b>	<b>Industrial Controllers</b>			<b>373</b>
	Industrial Controllers			
<b>10</b>	<b>Power Supply</b>			<b>378</b>
	Single, Dual, Triple Power Supplies Programmable Voltage Source	Programmable Power Supplies Power Supplies for System Use (IEEE)	Power Supplies with High Output Power Supplies with ARB Function	
<b>11</b>	<b>Measurement Accessories</b>			<b>409</b>
	RF Step Attenuators, Relay Matrices Attenuators, Terminations	Power Splitters Matching Pads	Coaxial Components Adapters for RF Connectors	
<b>Appendix</b>				<b>424</b>
	Documentation, Training	Repair, Calibration Hotline, Rentals, Leasing	Cabinets, Designs and Accessories	
<b>Addresses, Type/Data Sheet Index</b>				<b>433</b>



Catalog Contents

Type Index

R&S Addresses



## Company Profile



### Expertise in test and measurement, radiocommunications, radiomonitoring and broadcasting

#### A world leader

Rohde & Schwarz is an internationally active company in the fields of test and measurement, information technology and communications, with 5900 employees and worldwide sales of approx. € 870 million. For 70 years, Rohde & Schwarz has been at the forefront of technology. Today our name is synonymous around the world with innovation, precision and quality.

#### A local partner

We are represented in more than 70 countries. Our headquarters are in Germany, and we have area support centers in the USA, China, Japan, Singapore, Brazil and Abu Dhabi. Along with service centers in every major market, that means you are never far from Rohde & Schwarz expertise.

#### Recognized innovation

Rohde & Schwarz is among the technical leaders in all its business fields. Many of our products aren't merely better, they're unique. Our instruments and systems set standards worldwide in research, development, production and service.

Rohde & Schwarz equipment plays an important part in the mobile phone and wireless industry as well as in broadcasting, military and ATC communications, and a host of other application areas. We supply solutions for:

- ◆ Test and measurement – signal generators, spectrum and network analyzers, mobile radio, EMC, and other RF and microwave equipment
- ◆ Radiocommunications – ATC, avionics, and military systems
- ◆ Mobile radio – trunked radio systems
- ◆ Broadcasting – audio and video transmitters, measurement, and monitoring systems
- ◆ Radiomonitoring and radiolocation – receivers, direction finders, signal analyzers and antennas
- ◆ Communications security

#### Tried-and-tested quality

Our quality and environmental management system is certified to DIN EN ISO 9001 and 14001, and complies with AQAP 110 and 150 standards. We are approved for the development, production, installation and servicing of avionic communications equipment. We were the first German transmitter manufacturer to be authorized by the German government to perform approval tests for radio transmitter systems.

#### Helping set the standards

As one of the world's leading manufacturers, we participate in numerous associations and standardization bodies, such as ITU, ETSI, 3GPP, CISPR or IEC.

#### Trusted support

As an independent manufacturer, we know that long-term customer satisfaction is essential to our success. Accordingly, we make the extra effort to provide customer service and support that is second to none. Our extraordinarily comprehensive range of services helps customers get the best performance and the most value out of their investment in Rohde & Schwarz technology. Our fast support helps customers handle challenges. In all of our markets, we have built a reputation for responsiveness that we are proud of.



Catalog Contents

Type Index

R&S Addresses





Catalog Contents

Type Index

R&S Addresses



## Business Fields

### Leadership in test and measurement

Rohde&Schwarz is one of the world's leading manufacturers of electronic test and measurement equipment. Our instruments and systems set the world standards in many areas. As key partners for developers, manufacturers and network operators, we supply equipment and systems for:

#### Mobile radio measurement

- ◆ Complete range of measuring instruments, test sets and systems for mobile and base stations for analog and digital mobile communication networks
- ◆ Radiocommunication testers for use in service, production and development
- ◆ Go/Nogo testers
- ◆ Signal generators and analyzers, power meters
- ◆ Coverage and interference measurement systems
- ◆ Type-approval test systems

#### EMC and field-strength measurement

- ◆ Complete EMC test centers
- ◆ Turnkey systems for measuring electromagnetic interference (EMI) and electromagnetic susceptibility (EMC)
- ◆ Test receivers and EMI spectrum analyzers for compliance and precompliance measurement
- ◆ Full range of accessories:
  - Artificial mains networks
  - Antennas and masts
  - Field probes
  - Transducers
- ◆ Software

### General-purpose, microwave, and RF measurement

- ◆ RF and microwave signal generators
- ◆ ARB generators
- ◆ Spectrum and network analyzers
- ◆ Voltmeters and power meters
- ◆ Field-strength test receivers
- ◆ Process controllers
- ◆ Power supply units

#### Automatic test systems

- ◆ Type-approval and certification test systems
- ◆ Production test systems for communications terminal equipment
- ◆ Coverage measurement systems for all modern radio network types
- ◆ EMC test systems and test centers
- ◆ Board test systems (in-circuit and functional testers)
- ◆ Monitoring, coverage and transmitter test systems for both analog and digital sound and TV broadcasting

### Radiocommunications systems

Rohde&Schwarz is a leading international supplier of HF, VHF, and UHF radio systems for stationary and mobile applications. Our systems are used by governments and armed forces around the world for voice, data, and image transmission.

#### Air traffic control

- ◆ VHF and UHF radio systems for ground-air communications
- ◆ Radio direction-finding systems
- ◆ Remote monitoring and control of ATC systems
- ◆ Mobile ATC towers

### Air defense systems

- ◆ VHF/UHF radio systems for voice and data transmission
- ◆ Integrated technology for secure transmission
- ◆ Network management, including remote control and monitoring

#### Avionics

- ◆ HF, VHF, and UHF airborne transceivers for secure voice and data transmission

#### Naval communications

- ◆ Internal and external communications systems
- ◆ Integrated control and message handling systems
- ◆ HF broadband systems

#### Ground forces communications and IT

- ◆ Tactical multiband radio equipment
- ◆ HF transmission and receiving systems for stationary and mobile use
- ◆ Network integration and interfacing
- ◆ Frequency and key management

### Mobile radio

Rohde&Schwarz is among the leading vendors of MPT-1327 and TETRA mobile radio systems. Our customers include government agencies, public transportation systems and public network operators. We provide:

- ◆ Switching systems
- ◆ Base stations
- ◆ Network management systems
- ◆ Applications



Catalog Contents

Type Index

R&S Addresses





Catalog Contents

Type Index

R&S Addresses



## Business Fields

### Broadcasting

Rohde&Schwarz is the world's only manufacturer of a complete range of transmission, monitoring, and measuring equipment for sound and TV broadcasting. We lead the field in T&M systems and instruments for DAB, DVB/ATSC and MPEG-2.

#### Sound and TV broadcast transmitters

- ◆ VHF FM broadcast transmitter systems
- ◆ Analog TV transmitter systems
- ◆ Digital audio broadcast (DAB) systems
- ◆ Digital video broadcast (DVB-T, ATSC) systems

#### Measurement and monitoring systems

- ◆ Monitoring systems for terrestrial transmitter stations
- ◆ Measurement systems for transmitter development, production and maintenance

#### Video and broadcast measurement

- ◆ Generators and analyzers for MPEG-2, DVB and ATSC transport streams, for development, production and monitoring
- ◆ Picture quality analyzers
- ◆ Analog baseband generators and analyzers
- ◆ Signal generators and test receivers, modulators and demodulators for analog sound and TV broadcast standards as well as DVB-C/S, DVB/T and DTV-ATSC
- ◆ TV network analyzers
- ◆ Studio measurement equipment

### Radiomonitoring and radiolocation

Rohde&Schwarz is a major vendor of equipment and systems for the detection, location, and analysis of radiocommunications signals, for:

- ◆ Internal and external security
- ◆ National and international radiomonitoring
- ◆ Frequency management

We lead in the design and implementation of full-coverage automatic radiomonitoring and frequency management systems.

#### Receivers

- ◆ Fast search receivers
- ◆ Stationary and portable monitoring receivers
- ◆ Computer-controlled receiving systems

#### Direction finders

- ◆ Extremely fast broadband digital radiomonitoring direction finders for stationary and mobile use
- ◆ Automatic radiolocation networks using direction finders

#### Signal analyzers

- ◆ Versatile signal analyzers for many applications
- ◆ Automatic signal classifiers
- ◆ Signal decoders and demodulators

#### Antennas

- ◆ Receiving and transmitting antennas
- ◆ Test antennas
- ◆ Complex antenna systems

### Communications security

Rohde&Schwarz develops professional hardware and software crypto solutions, as stand-alone products and as crypto modules. Our solutions protect information in data processing and communications systems. We also conduct security analyses for industry and government bodies.

- ◆ Hardware and software crypto products
- ◆ Customized crypto systems
- ◆ Consulting and IT security analyses

### Services

We offer a full range of services. Our systems integration service provides complete turnkey test solutions, from planning and development through to implementation.

We also offer all the services necessary to get the optimum benefit from our products:

- ◆ Calibration, repair, and maintenance
- ◆ Customer-specific systems development
- ◆ Seminars and training
- ◆ Technical documentation and logistics



Catalog Contents

Type Index

R&S Addresses





Contents Overview

Chapter Overview

Type Index

R&S Addresses



**R&S® CMU200: THE tester for current and future Mobile Radio Networks with scalable multimode functionality**

## Contents of Chapter 1

Designation	Type	Description	Page
Universal Radio Communication Tester	R&S® CMU200	THE tester for current and future mobile radio networks: premium cost effectiveness, extremely fast measurement speed plus very high accuracy	6
Universal Radio Communication Tester	R&S® CMU300	Base station tester for development, production, system test, installation and service	14
Bluetooth® Testers	R&S® CBT/CBT32	Fast and versatile for development, production and verification	18
Base Station Tester (GSM900/1800/1900)	R&S® CMD57	For production, installation and service of GSM900/1800/1900 base stations (GSM 1900 standard optional)	21
Mobile Station Radiocommunication Test Set	R&S® CRTU-G	Test set for protocol verification of GSM terminal equipment	25
Protocol Tester	R&S® CRTU-S	Cost-effective multibox and data application testing	28
Protocol Tester	R&S® CRTU-W	Protocol test solution for 3G user equipment (UE)	30
Mobile Station Service Tester	R&S® CTS55 R&S® CTS60, 65	Fast conclusive measurements in service for GSM900, GSM 1800 or GSM 1900 mobile phones	34
DECT Tester	R&S® CMD60	Compact unit for testing cordless telephones to DECT standard (Digital European Cordless Telephone). Fully automatic testing with logging of results	37
DECT Signalling Test Unit	R&S® PTW15	Support in installation and maintenance of DECT networks	40
WLAN Protocol Tester	R&S® PTW70	IEEE 802.11 multimode protocol tester for development, integration and verification	42
Analog Radio Testers	R&S® CMS50 R&S® CMS54	Compact radio tester for service and production Same as R&S® CMS50, but more measurement functions and higher accuracy	46
Antenna Coupler, RF Shielding Cover, Bluetooth Antenna, USB feed-through	R&S® CMU-Z10/ -Z11/-Z12/-Z13	Simple coupling and interference-free testing of mobile phones in all frequency bands	52
Mobile Radio Test Systems	R&S® TS...	Turnkey test systems for use in service, production, type-approval testing, etc	330



Contents Overview

Chapter Overview

Type Index

R&S Addresses



## Universal Radio Communication Tester R&S®CMU200

**THE multiprotocol tester for current and future mobile radio networks with scalable multimode functionality**

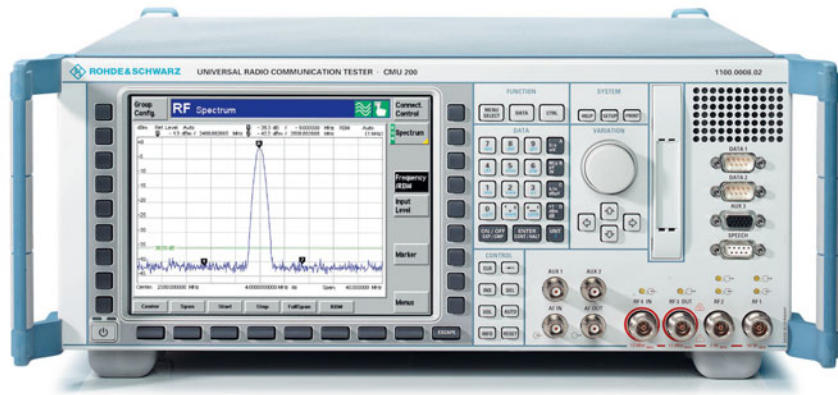

### Brief description

The Radio Communication Tester R&S®CMU200 brings premium cost effectiveness through a variety of features, with extremely fast measurement speed and very high accuracy being the two most important ones. In addition, the secondary remote addressing of the tester's modular architecture makes for intelligent and autonomous processing of complete measurement tasks and fast control program design.

The base unit without any options installed can be used for testing general parameters of 1st, 2nd or 3rd generation mobile phones. The R&S®CMU200 base unit is the ideal solution for tasks at the module level, i.e. at the early production stages of all cellular standards. Integral parts of the R&S®CMU200 base unit are the RF generator and RF analyzer, which are complemented by a versatile, network-independent time domain menu and a comprehensive spectrum analyzer.

The R&S®CMU200 is part of a complete range of mobile radio test equipment, encompassing everything from conformance test systems to system simulators, turnkey functional board test/final test systems and simple sales-counter Go/NoGo testers.

### Applications

- ◆ RF development
- ◆ Module design
- ◆ Module test in production
- ◆ Adjustment of mobiles
- ◆ Final test in production
- ◆ Functional test
- ◆ Feature test
- ◆ High-end service
- ◆ Quality inspections
- ◆ Basis for test systems
- ◆ Base station simulation

### Main features

- ◆ Extremely high-speed testing
- ◆ Highly accurate measurements
- ◆ Excellent result repeatability
- ◆ Fast switching between networks
- ◆ Comprehensive spectrum analyzer
- ◆ Modular hardware and software concept provides easy expansion to further functionality
- ◆ Easy migration to emerging standards
- ◆ Very flat menu structure with context-sensitive selection, entry and configuration pop-up menus
- ◆ Extremely low power consumption and effective heat conduction result in unparalleled reliability

### Characteristics

The base unit with its standard-independent module test provides many general-purpose measurement facilities for the development of all kinds of standards within its wide and continuous frequency range. If extended by the appropriate options, the R&S®CMU200 offers the hardware and software necessary to handle your 3G, 2.5G and previous-generation testing applications, including analog.

### GSM characteristics (option)

Currently, the following GSM systems are deployed in support of numerous applications worldwide:

- ◆ GSM400
- ◆ GSM850
- ◆ GSM900 including
  - P-GSM (primary GSM)
  - E-GSM (extended GSM)
  - R-GSM (railway GSM)
- ◆ GSM1800 (DCS)
- ◆ GSM1900 (PCS)

Whether the application is in production, service or development, the flexible concept of the R&S®CMU200 can handle practically all requirements: from basic RF signal generation, frequency, power and

## Universal Radio Communication Tester R&S®CMU200

spectrum analyzer measurements for the alignment of modules in production or development, to full GSM-specific signaling in any of the GSM bands, as well as module tests on frequencies anywhere in the range from 10 MHz to 2.7 GHz.

### GMSK/8PSK measurements

- ◆ Phase/frequency error, EVM, magnitude error, origin offset, I/Q imbalance GMSK for I/Q modulator tuning
- ◆ Power versus time
  - On up to 4 UL slots
  - Normal/access
  - Peak power/average, power versus frame, power versus slot
- ◆ High-speed ACP measurement (switching and modulation measurement in parallel) with additional time domain view
- ◆ Timing error
- ◆ BER/DBLER, RBER/FER, FastBER BLER@4DL (GPRS/EGPRS)
- ◆ Incremental redundancy support (EGPRS)
- ◆ Power versus PCL (on 3 or 7 channels)

### Benchmark-breaking IEC/IEEE bus speed due to

- ◆ Parallel measurements
- ◆ Fast production test mode (Rohde&Schwarz-proprietary)
- ◆ New fast modulation spectrum measurement (requires R&S®CMU-U65)
- ◆ Optimized processing power using latest DSP generations
- ◆ Statistical BER test based on confidence evaluation

### High flexibility for R&D

- ◆ Assignment on up to 8 UL and DL slots (TS 0 to 7)
- ◆ TX/RX on any transmit slot
- ◆ Individual level generation on any DL slot used

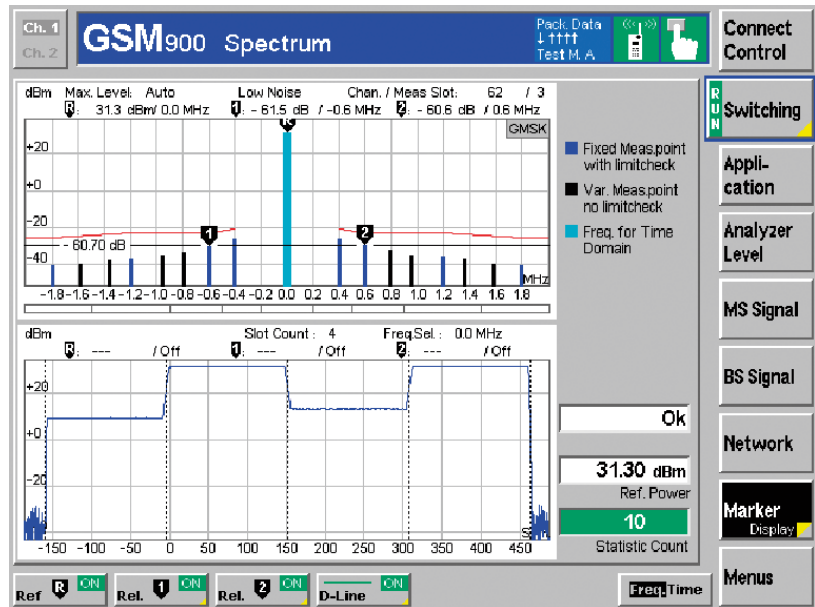

*The newly designed spectrum application allows the simultaneous measurement of spectra due to switching and modulation. With the R&S®CMU-U65 option, this can be done virtually in realtime. Moreover, the user can select a frequency offset (spectral line) by means of a marker and display it in the time domain. Transient characteristics in spectrum-due-to-switching measurements can thus be shown as a function of time*

- ◆ 3GPP packet data test mode supporting modes A, B and EGPRS loop
- ◆ GPRS/EGPRS TBF reconfiguration during established link
- ◆ GPRS/EGPRS intra-band handover

### TDMA characteristics (option)

The R&S®CMU200 simulates a TDMA base-station RF interface including the signalling protocol so that a mobile phone can be tested with regard to different signalling parameters. All necessary network and base-station parameters can be set, such as control and traffic channel configuration, neighbouring channels setup, etc. MAHO report can also be generated. The non-signalling mode is for generating and analyzing TDMA (IS-136) signals in the frequency range from 10 MHz to 2.7 GHz.

### Basic features

- ◆ Call to or from mobile phone
- ◆ Handoff to AMPS
- ◆ Dual-band handoff

### Signalling measurements

- ◆ MAHO report
- ◆ Power versus time
  - Short burst
  - Normal burst
- ◆ Modulation
  - Phase error
  - Magnitude error
  - EVM/EVM10
  - Overview of phase/magnitude and EVM simultaneously
- ◆ Spectrum
  - Adjacent channel power due to switching or modulation
- ◆ Overview
  - Signalling information

## Universal Radio Communication Tester R&S®CMU200

### Non-signalling measurements

- ◆ Modulation
- ◆ Spectrum
- ◆ Power versus time
- ◆ BER

### AMPS characteristics (option)

- ◆ Wide frequency range allowing dual-mode/dual-band testing
- ◆ Powerful signalling capabilities
- ◆ Base station simulation
- ◆ Mobile or base station originated call connect/disconnect
- ◆ Short measurement time ensuring high throughput
- ◆ Combined measurements
- ◆ Simple interactive operation, standardized MMI
- ◆ No specialized network knowledge required
- ◆ Various handoffs from cdma2000/TDMA and to TDMA supported

### Transmitter measurements

- ◆ Carrier power
- ◆ Carrier frequency error
- ◆ SAT frequency error/peak deviation
- ◆ ST frequency error/peak deviation
- ◆ Modulation noise and distortion
- ◆ Hum and noise
- ◆ Electrical AF response
- ◆ Modulation distortion
- ◆ Residual AM

### Receiver measurements

- ◆ Sensitivity
- ◆ Hum and noise
- ◆ SINAD
- ◆ Distortion
- ◆ AF voltage
- ◆ Electrical AF response
- ◆ Residual AM
- ◆ Audio deviation

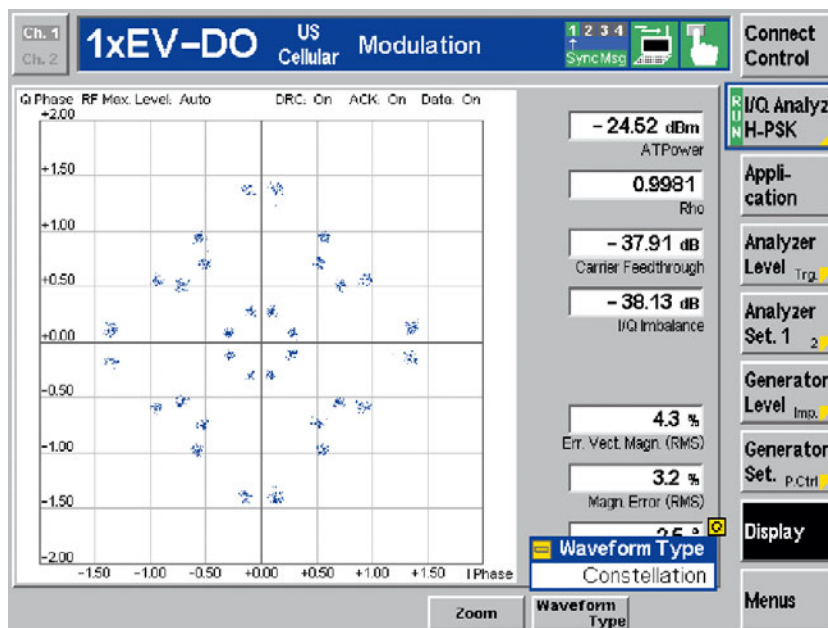

The I/Q analyzer provides a constellation diagram as well as an eye pattern for the I and Q component.

### 1xEV-DO characteristics (option)

With the 1xEV-DO option, the R&S®CMU200 offers a very flexible all-in-one solution including a 1xEV-DO generator for receiver measurements of 1xEV-DO access terminals as well as an extensive list of transmitter measurements. The test concept is based on the factory test mode (FTM) which provides direct control of the DUT without complete signalling. The FTM is implemented via the serial diagnostic monitor interface which is already present in most 1xEV-DO terminal designs. The factory test mode minimizes test configuration and transition time between tests and allows simultaneous testing of different DUTs. Enhanced measurement times and optimized test sequences are a special benefit especially in production environments, yielding higher throughput.

### 1xEV-DO features

- ◆ Simultaneous testing of up to four access terminals
- ◆ Reduced test times in comparison to full signalling tests
- ◆ Extremely flexible 1xEV-DO generator allows vendor-specific tests and new test scenarios
- ◆ Channel filters allow the reverse link signal to be evaluated in eight different states
- ◆ Combines 1xEV-DO with cdma2000 test applications in one box for dual-mode cdma2000/1xEV-DO testing
- ◆ All band classes used are supported
- ◆ Code domain power includes time switching between RRI and pilot channel
- ◆ Different network conditions can be simulated by a user-definable number of additional users in the forward link





Contents Overview

Chapter Overview

Type Index

R&S Addresses



## Universal Radio Communication Tester R&S®CMU200

### cdma2000 1X characteristics (option)

Similarity in physical conditions and downward compatibility make the cdma2000 1X T&M concept very similar to that of cdmaOne. There are, however, major differences in the protocols.

The R&S®CMU200 supports connections in all radio configurations defined for cdma2000 1X, i.e. TIA/EIA-95 connections as well as the usual cdma2000 1X high-speed connections.

Code domain power is a new and highly important measurement for mobile phones in cdma2000. Since several code channels are now transmitted simultaneously in the reverse link, it is necessary to check whether the power distribution of the different channels complies with the test specification (TIA/EIA-IS-98-E) for cdma2000. The measurement concept in the R&S®CMU200 is based on ProbeDSP™ technology, which permits high-speed measurement of the code domain power. The emphasis is on fast measurements and clear and concise representation.

Of course, the R&S®CMU200 also supports the requirements placed on the gpsOne test application; the R&S®CMU200 meets the high demands for frequency and phase accuracy.

The cdma2000 1X implementation in the R&S®CMU200 is based on the TIA/EIA IS-2000 Rev. 0 standard. However, features of Rev. A are partly implemented. The R&S®CMU200 currently supports, for example, FER measurements on two supplemental channels (SCH0 and SCH1).

### cdma2000 1X features

- ◆ cdma2000 speech coder for high-precision acoustic measurements
- ◆ Multiple connection types to cover most important test requirements in R&D, production and high-level service labs
- ◆ Forward closed-loop power control tests as specified in IS-98E sections 3.4.7, 3.4.8, 3.4.9 supported
- ◆ Quick paging channel implemented
- ◆ Handoffs possible between service options and between cdma2000 and IS-95 connection types during an established call
- ◆ Measurements under fading conditions supported (baseband fading; requires option R&S®CMU-B17 in combination with a fading generator such as the R&S®ABFS)
- ◆ Voice loopback and comprehensive testing of mobile phones
- ◆ Full support of RC1/RC2 (cdmaOne measurements) and RC3/RC4 (cdma2000)
- ◆ Support of all band classes specified in IS-2000
- ◆ Innovative measurement of code domain power, code domain peak error power, channel power
- ◆ Parallel RX/TX measurements ensuring high throughput in production environments
- ◆ Graphical representation of measurement results best suited for R&D labs
- ◆ Readout and display of many mobile-phone-specific parameters (ESN, slot cycle index, etc)
- ◆ Extremely fast measurements
- ◆ Non-signalling and signalling mode
- ◆ Various handoffs supported (e.g. handoff to AMPS, interband handoff)

### WCDMA characteristics (option)

The tests provided by the R&S®CMU200 are currently based on the 3GPP/FDD Release 99 WCDMA radio link standards. Regular adaptations to new releases and baselines will be made available as the standard evolves; thus the R&S®CMU200 is already prepared for Release 5. Most of the measurements offered comply with the 3GPP specification TS 34.121, chapter 5 (Transmitter Characteristics), chapter 6 (Receiver Characteristics) and chapter 7 (Performance Tests). The R&S®CMU200 can be fitted with an FDD transmitter tester, an additional FDD generator, and FDD signalling hardware. Depending on the application, only the first or the first two might be needed, allowing T&M budgets to be optimized. The three parts allow the R&S®CMU200 to be configured for non-signalling TX, TX/RX or signalling TX/RX measurements and functional testing on the UE (user equipment) according to 3GPP specification. Due to the highly user-friendly menu concept, the R&S®CMU200 provides quick access to all required measurements and optimizes the handling and thus the efficiency of complex measurement tasks with appropriate status messages and built-in statistical functions.

Different handover capabilities within WCDMA/FDD such as inter-frequency handover are available in the R&S®CMU200 WCDMA solution. Moreover, handover to other cellular networks such as GSM, i.e. inter-RAT handovers, are implemented and will also be expanded depending on the specification progress.



Contents Overview

Chapter Overview

Type Index

R&S Addresses



## Universal Radio Communication Tester R&S® CMU 200

### WCDMA features

- ◆ Shortest measurement time ensuring high throughput
- ◆ Benchmark-breaking ICE/IEEE bus speed (see highlights of base unit)
- ◆ Combined measurements, many different measurement modes
- ◆ Multiband/multimode testing
- ◆ Powerful signalling capabilities available: MOC, MTC, MIR, NIR, inter-frequency handover, inter-RAT handover, cell reselection
- ◆ Display of UE properties
- ◆ Large selection of radio access bearers (RABs) with various data rates
- ◆ Up to 384 kbit/s reference measurement channels (symmetrical and asymmetrical)
- ◆ 3GPP-conforming generation of OCNS (orthogonal noise signals)
- ◆ Separate and highly accurate level setting for each individual DL code channel
- ◆ Simple voice test using RAB/echo by tester; dedicated audio tests available (option)
- ◆ User-defined settings of RF-relevant signalling parameters
- ◆ 3G dedicated trigger options
- ◆ External message analyzer for reading signalling message log files (option)
- ◆ Simple interactive operation in manual MMI
- ◆ No specialized network knowledge required
- ◆ Stimulation of compressed mode patterns soon available
- ◆ Compressed mode measurements soon available

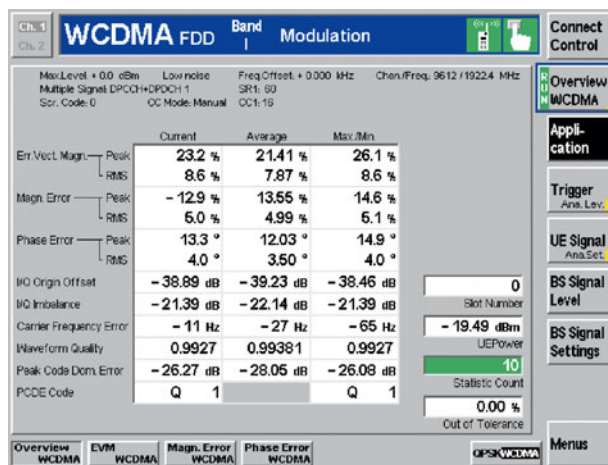

*The modulation overview menu provides fast, comprehensive information on the UE's RF performance. The hotkeys at the bottom of the screen provide immediate access to specific and detailed measurements*

### Bluetooth® characteristics (option)

The R&S® CMU 200 was the first *Bluetooth* test set on the market. It is the only radiocommunication tester worldwide to offer Bluetooth as well as all important mobile radio standards in a single instrument.

The R&S® CMU 200 with the *Bluetooth* option is the ideal instrument for the production, development and maintenance of any kind of device with an integrated *Bluetooth* interface. Due to its modular platform concept, the R&S® CMU 200 is the ideal solution for all cellular-standard mobile-phone production lines.

Due to the high measurement speed and large memory capacity of the R&S® CMU 200, transmitter and receiver measurements can be carried out simultaneously. When measurements are performed in frequency hopping mode, a significant test depth is rapidly attained. Only a few seconds are required between call setup, transmitter and receiver measurements and call detach. Fast test cycles ensure a fast return on investment.

- ◆ *Bluetooth* Core Specifications Version 1.1 (DUTs to 1.2 can also be measured)
- ◆ RF Test Specification Version 0.92
- ◆ Measurements in *Bluetooth* test mode, non-test mode or without a connection
- ◆ Selectable channels and stop conditions for in-depth signal analysis
- ◆ Park, hold and sniff modes for power consumption tests
- ◆ Audio codec integrated (CVSD, A-law,  $\mu$ -law) for test of audio equipment
- ◆ High measurement accuracy and speed
- ◆ Parallel TX and RX measurement of the RF interface in loopback mode
- ◆ Output of *Bluetooth*-specific clock signal
- ◆ IF signal output

### I/Q and IF interfaces (option)

The R&S® CMU-B17 option allows access to analog I/Q and IF signals in both communication directions (uplink and downlink). Once a radio link has been established, complex I/Q signals can be applied or transmitted for further analysis.

## Universal Radio Communication Tester R&S®CMU200

Fitted with the R&S®CMU-B17 option, the R&S®CMU200, together with the Fading Simulator R&S®ABFS, provides a cost-effective solution for the specified measurement task. Optionally, the Signal Generator R&S®SMIQ with the option R&S®SMIQB14 can be used; the transmit module of the generator can also provide a faded RF signal.

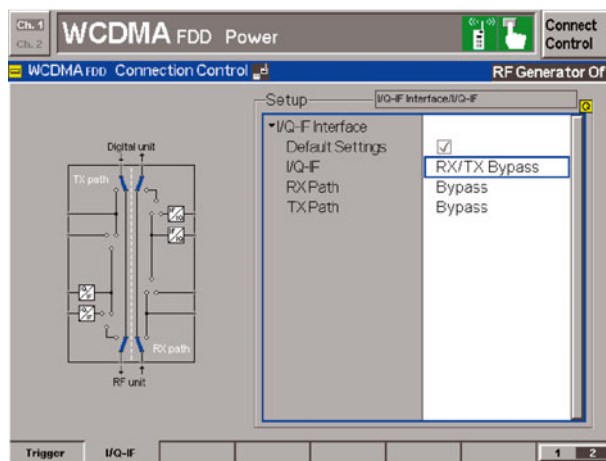

*Menu in the R&S®CMU200 for setting the test paths (default setting: RX/TX bypass mode)*

### Specifications in brief

You will find detailed and binding data on the enclosed CD (./DATASHEET/CMU200.pdf), or, for the latest updates, visit [www.rohde-schwarz.com](http://www.rohde-schwarz.com), search term: **CMU200**

#### RF generator

Frequency range	100 MHz to 2700 MHz
Frequency resolution	0.1 Hz
Frequency settling time	<400 μs to Δf <1 kHz
<b>Output level range</b>	
<b>RF1</b>	
100 kHz to 2200 MHz	-130 dBm to -27 dBm
2200 MHz to 2700 MHz	-130 dBm to -33 dBm
<b>RF2</b>	
100 kHz to 2200 MHz	-130 dBm to -10 dBm
2200 MHz to 2700 MHz	-130 dBm to -16 dBm
<b>RF3<sub>OUT</sub></b>	
100 kHz to 2200 MHz	-90 dBm to +13 dBm
2200 MHz to 2700 MHz	-90 dBm to +5 dBm

#### RF analyzer

<b>Power meter (frequency-selective)</b>	
Frequency range/resolution	10 MHz to 2700 MHz/0.1 Hz
Resolution bandwidths	10 Hz to 1 MHz in 1/2/3/5 steps
Level range for rated data	
<b>RF1 (continuous power)<sup>1)</sup></b>	
10 MHz to 2200 MHz	-40 dBm to +47 dBm (50 W)
2200 MHz to 2700 MHz	-34 dBm to +47 dBm (50 W)
Max. peak power <sup>2)</sup> (PEP)	+53 dBm (200 W)
<b>RF2 (continuous power)<sup>1)</sup></b>	
10 MHz to 2200 MHz	-54 dBm to +33 dBm (2 W)
2200 MHz to 2700 MHz	-48 dBm to +33 dBm
Max. peak power <sup>2)</sup> (PEP)	+39 dBm (8 W)
<b>RF4<sub>IN</sub> (continuous power and PEP)</b>	
10 MHz to 2200 MHz	-80 dBm to 0 dBm
2200 MHz to 2700 MHz	-74 dBm to 0 dBm

#### Spectrum analyzer

Frequency range	10 MHz to 2.7 GHz
Span	zero span to full span
Frequency resolution	0.1 Hz
Resolution bandwidths	10 Hz to 1 MHz in 1/2/3/5 steps

#### Audio option R&S®CMU-B41

<b>AF sine generator</b>	
Frequency range	20 Hz to 20 kHz
Frequency resolution	0.1 Hz
Level range	10 μV to 5 V
<b>AF voltmeter</b>	
Frequency range	50 Hz to 20 kHz
Level range	50 μV to 30 V

#### General data

Rated temperature range	+5 °C to +45 °C
Storage temperature range	-25 °C to +60 °C
Power supply	100 V to 240 V ±10% (AC), 3.1 A to 1.3 A, 50 Hz to 400 Hz, -5% to +10% power factor correction
Power consumption	
Base unit	130 W
with typical options	180 W
Dimensions (W × H × D)	465 mm × 193 mm × 517 mm (19"; 4 height units)
Weight base unit	14 kg
Weight with typical options	18 kg

- 1) 50 W in the temperature range +5°C to +30°C, linear degradation down to 25 W at 45°C.
- 2) Mean value of power vs time must be equal or less than allowed continuous power.

## Universal Radio Communication Tester R&S® CMU 200

Ordering information (continued on the next page)

Type	Description	GSM/GPRS/ EDGE/HSCSD	TDMA	AMPS	cdma2000	WCDMA	Bluetooth	Order No.
<b>R&amp;S® CMU 200</b>	Base unit with following accessories: power cord, operating manual, service manual for instrument	✓	✓	✓	✓	✓	✓	1100.0008.02
<b>R&amp;S® CMU-B11<sup>1)</sup></b>	Reference OCXO, aging $2 \times 10^{-7}$ /year; ensures high absolute accuracy, minimum temperature-dependent drift and especially high long-term stability; used for measurements with exact frequency stability requirements	☺	☺	☺	☺	☺	☺	1100.5000.02
<b>R&amp;S® CMU-B12<sup>1)</sup></b>	High-stability OCXO, aging $3.5 \times 10^{-9}$ /year. Oven crystal with highest long-term stability; ensures compliance with tolerances specified by GSM; used for highly demanding frequency stability requirements to GSM 11.20	☺	☺	☺	☺	☺	☺	1100.5100.02
<b>R&amp;S® CMU-B17</b>	Analog I/Q IF interface	☺	☺	–	☺	☺	–	1100.6906.02
<b>R&amp;S® CMU-B21</b>	Universal signalling unit; provides multistandard signalling hardware; required for WCDMA 3GPP FDD	✓	✓	✓	–	✓	✓	1100.5200.14
<b>R&amp;S® CMU-B41</b>	Audio generator and analyzer; includes audio frequency (AF) generator, voltmeter, distortion meter	☺	☺	✓	☺	☺	☺	1100.5300.02
<b>R&amp;S® CMU-B52</b>	Internal versatile multimode speech coder/decoder; R&S® CMU-B21 necessary	☺	☺	–	–	☺	☺	1100.5400.14
<b>R&amp;S® CMU-B53</b>	Bluetooth extension; R&S® CMU-B21 necessary	–	–	–	–	–	✓	1100.5700.14
<b>R&amp;S® CMU-B54</b>	Signalling module for AMPS, TDMA, GSM/GPRS/EGPRS; R&S® CMU-B21 necessary	☺	☺	☺	–	–	–	1150.2604.14
<b>R&amp;S® CMU-B56</b>	WCDMA (3GPP FDD) signalling module; R&S® CMU-B21 necessary	–	–	–	–	✓	–	1150.1850.14
<b>R&amp;S® CMU-B66<sup>1)</sup></b>	Versatile baseband board for WCDMA (3GPP FDD) Layer 1, DL, non-signalling	–	–	–	–	✓	–	1149.9509.02
<b>R&amp;S® CMU-B68<sup>2)</sup></b>	Versatile baseband board for WCDMA (3GPP FDD) Layer 1, DL and UL, non-signalling	–	–	–	–	✓	–	1149.9809.02
<b>R&amp;S® CMU-B69</b>	Option package WCDMA (3GPP/FDD) complete for band 1, signalling	–	–	–	–	✓	–	1150.2304.02
<b>R&amp;S® CMU-B73</b>	Analog telephone line interface	–	–	☺	–	–	–	1150.2004.02
<b>R&amp;S® CMU-B83</b>	cdma2000 1x signalling unit	–	–	–	✓	–	–	1150.0301.12
<b>R&amp;S® CMU-B85</b>	8k/13k QCELP, 8k EVRC speech codec for cdma2000 1 × Signalling Unit R&S® CMU-B83	–	–	–	☺	–	–	1100.7002.12
<b>R&amp;S® CMU-B87</b>	Message monitor for cdma2000 1x Signalling Unit R&S® CMU-B83	–	–	–	☺	–	–	1150.2404.02
<b>R&amp;S® CMU-B88</b>	cdma2000 1xEV-DO (HDR) extension board for cdma2000 1 × Signalling Unit R&S® CMU-B83	–	–	–	☺	–	–	1158.9908.02
<b>R&amp;S® CMU-B95</b>	2nd TX RF channel; BCCH always present with GSM/GPRS/EGPRS	☺	–	–	–	–	–	1159.0504.02
<b>R&amp;S® CMU-B99</b>	RF1 level range identical to RF2	☺	☺	☺	☺	☺	☺	1150.1250.02
<b>R&amp;S® CMU-DCV</b>	Documentation of calibration values	☺	☺	☺	☺	☺	☺	0240.2193.08
<b>R&amp;S® CMU-K20</b>	GSM400 mobile station signalling/non-signalling test software	✓	–	–	–	–	–	1115.5900.02
<b>R&amp;S® CMU-K21</b>	GSM900, R-GSM and E-GSM mobile station signalling/non-signalling test software	✓	–	–	–	–	–	1115.6007.02
<b>R&amp;S® CMU-K22</b>	GSM1800 (DCS) mobile station signalling/non-signalling test software	✓	–	–	–	–	–	1115.6107.02
<b>R&amp;S® CMU-K23</b>	GSM1900 (PCS) mobile station signalling/non-signalling test software	✓	–	–	–	–	–	1115.6207.02
<b>R&amp;S® CMU-K24</b>	GSM850 mobile station signalling/non-signalling test software	✓	–	–	–	–	–	1115.6307.02
<b>R&amp;S® CMU-K27</b>	IS-136/cellular (800 MHz band) mobile station signalling/non-signalling test software	–	✓	–	–	–	–	1115.6607.02
<b>R&amp;S® CMU-K28</b>	IS-136/PCS (1900 MHz band) mobile station signalling/non-signalling test software	–	✓	–	–	–	–	1115.6707.02
<b>R&amp;S® CMU-K29</b>	AMPS mobile station signalling/non-signalling test software	–	–	✓	–	–	–	1115.6807.02
<b>R&amp;S® CMU-K42</b>	GPRS test software extension for all GSM test software packages	☺	–	–	–	–	–	1115.4691.02

## Universal Radio Communication Tester R&S®CMU200

Type	Description	GSM/GPRS/ EDGE/HSCSD	TDMA	AMPS	cdma2000	WCDMA	Bluetooth	Order No.
<b>R&amp;S®CMU-K43</b>	EGPRS classic (EDGE) signalling test software for all GSM test software packages	☺	–	–	–	–	–	1115.6907.02
<b>R&amp;S®CMU-K45</b>	AMR test software extension for all GSM software packages	☺	–	–	–	–	–	1150.3100.02
<b>R&amp;S®CMU-K53</b>	Bluetooth test software; R&S®CMU-B53 necessary	–	–	–	–	–	✓	1115.5000.02
<b>R&amp;S®CMU-K65<sup>1)</sup></b>	WCDMA (3GPP/FDD) UL user equipment TX test, non-signalling test software	–	–	–	–	✓	–	1115.4891.02
<b>R&amp;S®CMU-K66<sup>3)</sup></b>	WCDMA (3GPP/FDD) DL generator, non-signalling test software; R&S®CMU-U66 or R&S®CMU-B66 necessary	–	–	–	–	✓	–	1115.5100.02
<b>R&amp;S®CMU-K67</b>	WCDMA (3GPP FDD) band 3, UE test signalling software; R&S®CMU-K65 and R&S®CMU-K66 necessary	–	–	–	–	✓	–	1150.3000.02
<b>R&amp;S®CMU-K68</b>	WCDMA (3GPP FDD) band 1, UE test signalling software; R&S®CMU-K65 and R&S®CMU-K66 necessary	–	–	–	–	✓	–	1115.5300.02
<b>R&amp;S®CMU-K69</b>	WCDMA (3GPP FDD) band 2, UE test signalling software; R&S®CMU-K65 and R&S®CMU-K66 necessary	–	–	–	–	✓	–	1115.5400.02
<b>R&amp;S®CMU-K83</b>	cdma2000 1× (450 MHz band) mobile station signalling/non-signalling test software	–	–	–	✓	–	–	1150.3500.02
<b>R&amp;S®CMU-K84</b>	cdma2000 1× (cellular band) mobile station signalling/non-signalling test software	–	–	–	✓	–	–	1150.3600.02
<b>R&amp;S®CMU-K85</b>	cdma2000 1× (PCS band) mobile station signalling/non-signalling test software	–	–	–	✓	–	–	1150.3700.02
<b>R&amp;S®CMU-K86</b>	cdma2000 1× (IMT2000 band) mobile station signalling/non-signalling test software	–	–	–	✓	–	–	1150.3800.02
<b>R&amp;S®CMU-K88</b>	cdma2000 1xEV-DO (HDR) test software; R&S®CMU-B88 necessary	–	–	–	☺	–	–	1150.3900.02
<b>R&amp;S®CMU-U65</b>	3G measurement DSP and performance accelerator	–	–	–	✓	✓	–	1100.7402.04
<b>R&amp;S®CMU-U80</b>	Trigger output connector for gpsOne	–	–	–	☺	–	–	1150.1750.02
<b>R&amp;S®CMU-Z1</b>	256 Mbyte memory card for use with PCMCIA interface; flash ATA formatted, also named PC Card ATA	☺	☺	☺	☺	☺	☺	1100.7490.04
<b>R&amp;S®CMU-Z6</b>	Enhancement of wideband modulation (WCDMA 3GPP FDD) analyzer accuracy	–	–	–	–	☺	–	1150.0001.02
<b>R&amp;S®CMU-Z10</b>	Antenna coupler 900 MHz/1700 MHz to 2200 MHz	☺	☺	☺	☺	☺	☺	1150.0801.02
<b>R&amp;S®CMU-Z11</b>	RF shielded cover for R&S®CMU-Z10	☺	☺	☺	☺	☺	☺	1150.1008.02
<b>R&amp;S®CMU-Z12</b>	Bluetooth antenna extension for R&S®CMU-Z10	–	–	–	–	–	☺	1150.1043.02
<b>R&amp;S®CMU-Z13</b>	USB feed through for R&S®CMU-Z10	☺	☺	☺	☺	☺	☺	1159.1200.02
<b>R&amp;S®CMU-Z46</b>	WCDMA (3GPP FDD) message analyzer and recorder	–	–	–	–	☺	–	1159.0804.02
<b>R&amp;S®CMU-Z49</b>	GSM message viewer	☺	–	–	–	–	–	1150.2704.02
<b>R&amp;S®CMU-Z50</b>	Handset for R&S®CMU200	☺	☺	☺	☺	☺	☺	1159.0104.02
<b>R&amp;S®CRT-Z12</b>	GSM850/PCS1900 GSM/GPRS test SIM for loopback mode, required for BER and other applications	☺	–	–	–	–	–	1139.1205.02
<b>R&amp;S®CRT-Z2</b>	GSM900/DCS1800 GSM/GPRS test SIM for loopback mode, required for BER and other applications	☺	–	–	–	–	–	1039.9005.02
<b>R&amp;S®CRT-Z3</b>	3G UICC/USIM test card for UMTS	–	–	–	–	☺	–	1139.1005.02
<b>R&amp;S®ZZA-411</b>	19" rack adapter	☺	☺	☺	☺	☺	☺	1096.3283.00

1) R&S®CMU-B11 or R&S®CMU-B12 possible. One or two OCXOs should be installed to ensure high frequency accuracy, or an external frequency reference may be used, if available.  
 2) For new units only. Factory installation only.  
 3) R&S®CMU-U65 necessary.

**Definition of table symbols:**  
 ✓ mandatory; ☺ optional; – not applicable

## Universal Radio Communication Tester R&S®CMU300

**Base station tester for development, production, system test, installation and service**

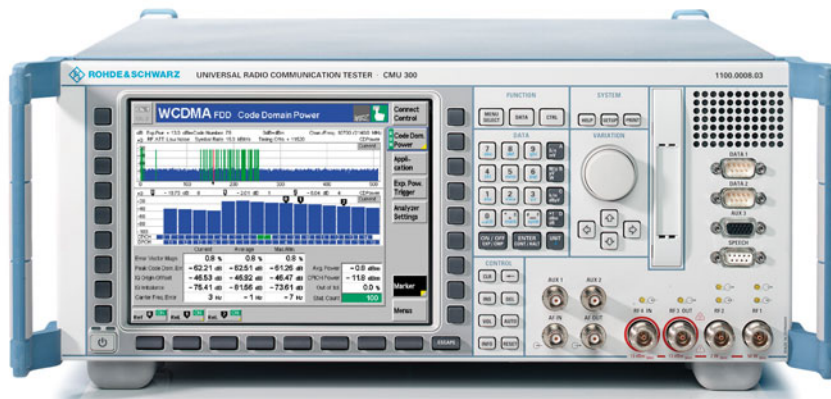

### Brief description

The Universal Radio Communication Tester R&S®CMU300 represents a new generation of compact test solutions for testing the RF interface of base stations. The tester, which follows the specifications of the standardization bodies, is suitable for performing transmitter and receiver tests.

The R&S®CMU300 features all the highlights of a modern tester: maximum measurement accuracy and speed combined with extremely high reliability and repeatability. The R&S®CMU300 from Rohde&Schwarz is a versatile platform for all applications in base station testing: development, production, system test, installation and service.

The tester keeps pace with all steps in the evolution of modern digital mobile radio. It supports GSM, GPRS, EDGE and WCDMA.

### Main features

- ◆ Wide frequency range from 10 MHz to 2.7 GHz
- ◆ Modular future-proof design
- ◆ Flexible RF input/output structure
- ◆ Spectrum analyzer function

- ◆ Measurements on first-, second- and third-generation base stations with a single instrument
- ◆ Manual operation or IEC/IEEE bus control
- ◆ Bright, high-resolution TFT colour display
- ◆ Realtime automatic temperature correction for maximum accuracy
- ◆ Low power consumption
- ◆ Low heat dissipation
- ◆ Optimized cooling concept for higher reliability and less production down times
- ◆ Compact box of only 4 height units
- ◆ Flexible configuration for compatibility with various test environments

### GSM/GPRS/EDGE functionality

In the non-signalling mode, the instrument consists of a GSM/EDGE generator and analyzer which can be operated independently of each other. As soon as an RF signal is applied to the test input, measurement can be started independently of external trigger signals or signalling sequences. This mode is ideal for testing RF boards and modules with little or no signalling activity.

In the signalling mode, however, the R&S®CMU 300 operates synchronously

with the base station, which is a prerequisite for BER measurements and real-time signalling. The signalling mode is suitable for final testing of TRX modules or the complete base station. In most cases, the instrument can be synchronized via the pilot channel (BCCH) of the base station. It is also possible to trigger the R&S®CMU300 via the frame clock.

### GMSK/8PSK transmitter measurements

The following measurements are available in signalling and non-signalling mode:

- ◆ Power/power ramp
- ◆ Modulation analysis
- ◆ Spectrum measurements

In the signalling mode, the following enhanced functions are available in addition:

- ◆ Selective choice of timeslot to be measured in frame
- ◆ Analysis of CCH information
- ◆ Analysis of SACCH information
- ◆ Measurement of power ramp of up to 4 successive bursts
- ◆ Fast measurement of average power of 8 bursts per frame in approx. 5 ms

## Universal Radio Communication Tester R&S®CMU300

### GSM/GPRS/EDGE receiver measurements

This is where the strengths of the R&S®CMU300 as a compact tester become obvious. The capability to generate and analyze different channels in realtime is the key prerequisite for continuous bit error rate (BER) measurement and for automatic search of the sensitivity limit. The R&S®CMU300 supports various measurement paths (PN generator/device under test (DUT)/BER evaluation). For the majority of channels to be measured, the test path can be routed via various closed loops within the base station or via the A<sub>bis</sub> interface. The R&S®CMU300 itself can be used as an RF loop. Bit error rate measurements can be performed on the following traffic channels:

- ◆ **GSM:** TCH/FS, TCH/HS, TCH/EF3, TCH/F14.4, TCH/F9.6, TCH/F4.8, TCH/H4.8, TCH/H2.4
- ◆ **GPRS:** PDTCH-CS1, PDTCH-CS2, PDTCH-CS3, PDTCH-CS4,
- ◆ **ECSD:** E-TCH/F43.2 NT
- ◆ **EGPRS:** PDTCH-MCS1, PDTCH-MCS2, PDTCH-MCS3, PDTCH-MCS4, PDTCH-MCS5, PDTCH-MCS6, PDTCH-MCS7, PDTCH-MCS8, PDTCH-MCS9

The RACH signalling channel can also be tested. For conformance tests, the R&S®CMU300 provides the following uplink signalling channels modulated with PSR data (option R&S®CMU-K38):

- ◆ FACCH/F
- ◆ SACCH
- ◆ SDCCH/4, SDCCH/8

The PSR data must be evaluated in the BTS or its controller. Further information on the test environment of the base station required to perform customer-specific BER tests can be obtained on request. Another special feature of the R&S®CMU300 is its capability of performing tests on hopping base stations.

### WCDMA functionality

#### 3GPP FDD receiver measurements

For receiver tests on WCDMA base stations, the R&S®CMU300 can be equipped with an RF generator (3GPP FDD, release 99). The instrument is thus able to generate all reference test channels specified in 3GPP TS 25.141 from 12.2 kbps up to 2048 kbps in real-time.

Test data sequences from PN9 to PN16 are supported. The R&S®CMU300 is triggered by the transmission time interval (TTI) signals of the base station. Moreover, it is able to feed measured data into the following physical channels:

- ◆ 15 kbps, 30 kbps, 60 kbps, 120 kbps, 480 kbps, 1 × 960 kbps, 2 × 960 kbps, 3 × 960 kbps, 4 × 960 kbps, 5 × 960 kbps, 6 × 960 kbps

#### 3GPP FDD transmitter measurements

The newly developed transmitter measurements in non-signalling mode are based on the 3GPP TS 25.141 FDD WCDMA specification. In implementing this solution, special emphasis was placed on high precision and measurement speed. The R&S®CMU300 measurements are based on the DL test models, including CPICH channel as defined in the specification.

- ◆ Power measurement
  - Power meter (wideband or frequency selective)
  - Code domain power (CDP)

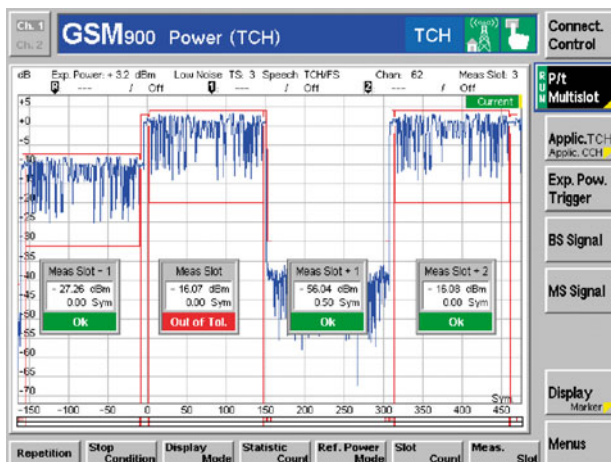

8PSK power versus Multislot measurement menu

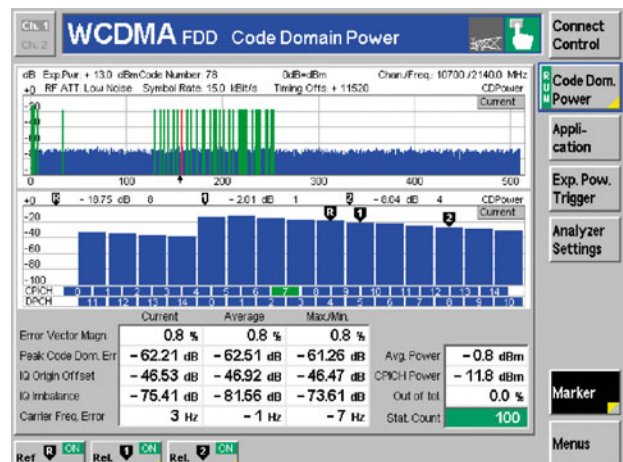

3GPP FDD code domain power measurement with test model 3.32

## Universal Radio Communication Tester R&S®CMU300

### Options, software, modification kits, extras and ordering information

Type/Option	Description	Comments on table: ✓ mandatory; ☺ optional; – not applicable 1) Depending on the required frequency band.	BERT GSM	BERT GPRS	BERT EGPRS	GMSK TX tests	8PSK TX tests	FDD UL-generator	FDD DL TX test	Order No.
<b>Hardware options</b>										
R&S®CMU-B12	Reference oscillator OCXO, aging $3.5 \times 10^{-8}$ /year		☺	☺	☺	☺	☺	–	–	1100.5100.02
R&S®CMU-B17	I/Q/IF interface, analog, one channel, (R&S®CMU300 factory installation only)		☺	☺	☺	☺	☺	☺	☺	1100.6906.02
R&S®CMU-B21	Versatile signalling unit for R&S®CMU		✓	✓	✓	✓	✓	–	–	1100.5200.02
R&S®CMU-B71	A <sub>bis</sub> interface unit; E1/T1 protocol; for BER test only		☺	–	–	–	–	–	–	1100.6406.02
R&S®CMU-B76	Layer1 board for WCDMA		–	–	–	–	–	✓	–	1150.0601.02
<b>SW options</b>										
R&S®CMU-K30	GSM400 BTS measurement software, R&S®CMU-B21 required		✓ <sup>1)</sup>	✓ <sup>1)</sup>	✓ <sup>1)</sup>	✓ <sup>1)</sup>	✓ <sup>1)</sup>	–	–	1115.4004.02
R&S®CMU-K31	GSM900 BTS measurement software, R&S®CMU-B21 required		✓ <sup>1)</sup>	✓ <sup>1)</sup>	✓ <sup>1)</sup>	✓ <sup>1)</sup>	✓ <sup>1)</sup>	–	–	1115.4104.02
R&S®CMU-K32	GSM1800 BTS measurement software, R&S®CMU-B21 required		✓ <sup>1)</sup>	✓ <sup>1)</sup>	✓ <sup>1)</sup>	✓ <sup>1)</sup>	✓ <sup>1)</sup>	–	–	1115.4204.02
R&S®CMU-K33	GSM1900 BTS measurement software, R&S®CMU-B21 required		✓ <sup>1)</sup>	✓ <sup>1)</sup>	✓ <sup>1)</sup>	✓ <sup>1)</sup>	✓ <sup>1)</sup>	–	–	1115.4304.02
R&S®CMU-K34	GSM850 BTS measurement software, R&S®CMU-B21 required		✓ <sup>1)</sup>	✓ <sup>1)</sup>	✓ <sup>1)</sup>	✓ <sup>1)</sup>	✓ <sup>1)</sup>	–	–	1115.4404.02
R&S®CMU-K38	Signalling channels (GSM/UL) with PSRB pattern modulation, R&S®CMU-K30 to -K33 requ.		☺	–	–	–	–	–	–	1150.3400.02
R&S®CMU-K39	GSM signalling procedure MOC/MTC (circuit-switched), R&S®CMU-K30 to -K33 required		☺	–	–	☺	☺	–	–	1115.4791.02
R&S®CMU-K41	EDGE/8PSK extension for GSM Hardware/Software (8PSK TX tests and EGPRS channel coders), R&S®CMU-K30 to -K33 required		–	–	✓	–	✓	–	–	1115.4504.02
R&S®CMU-K75	WCDMA TX test (3GPP FDD/DL), R&S®CMU-U75 required		–	–	–	–	–	–	✓	1150.3200.02
R&S®CMU-K76	WCDMA generator (3GPP FDD/UL), R&S®CMU-B76 required		–	–	–	–	–	✓	–	1150.3300.02
R&S®CMU-K77	AWGN generator and BER/BLER simulation (3GPP FDD/UL), R&S®CMU-K76 required		–	–	–	–	–	☺	–	1150.4107.02
<b>Further options</b>										
R&S®CMU-U10	HW modification: memory extension for 64 MByte CMU		☺	☺	☺	☺	☺	☺	☺	1159.0404.02
R&S®CMU-U74	Upgrade kit for units delivered before July 2003: high dynamic WCDMA spectrum measurements		–	–	–	–	–	–	☺	1159.0704.02
R&S®CMU-U75	Upgrade kit: measurement DSP module for WCDMA		–	–	–	–	–	–	✓	1150.0501.02
R&S®CMU-U76	Upgrade kit: layer 1 board for WCDMA (to be used for upgrade of existing units instead of R&S®CMU-B76)		–	–	–	–	–	☺	–	1150.0701.02
R&S®CMU-DCV	Documentation of calibration values		☺	☺	☺	☺	☺	☺	☺	0240.2193.08
R&S®CMU-DKD	R&S®CMU200/300 DKD calibration incl. ISO9000 calibration (order only with device)		☺	☺	☺	☺	☺	☺	☺	1159.4600.02
R&S®CMU-Z1	Accessory: 256 Mbyte memory card, PCMCIA type 3		☺	☺	☺	☺	☺	☺	☺	1100.7490.04
R&S®CMU-Z6	Accessory: enhancement of wideband modulation analysis		–	–	–	–	–	–	☺	1150.0001.02
R&S®ZAA-411	19"rack adapter		☺	☺	☺	☺	☺	☺	☺	1096.3283.00

- ◆ Modulation analysis
  - Error vector magnitude (EVM), magnitude error, phase error
  - Carrier frequency error
  - I/Q origin offset
  - I/Q imbalance
  - Waveform quality
  - Peak code domain error power (PCDEP)

- ◆ Spectrum measurement (inband)
  - Adjacent channel leakage power ratio (ACLR)
  - Occupied bandwidth (OBW)
  - Spectrum emission mask (SEM)

Performing these often very complex measurements, the R&S®CMU300 ventures into new speed ranges: The CDP measurement with channel model 3.32, for example, takes only about 0.3 seconds/frame – without even requiring additional external triggering.

### Options

The base unit of the R&S®CMU300 provides the functionality of two RF measuring instruments – an RF signal generator and an RF spectrum analyzer.

### GSM/EDGE

The base unit is converted into a radio-communication tester for GSM/GPRS by incorporating the Signalling Unit R&S®CMU-B21 and at least one of the five GSM software options R&S®CMU-K30 through -K34. The GSM functions can be enhanced to EDGE by software option R&S®CMU-K41. Software option R&S®CMU-K39 allows channel setup using the GSM signalling procedures MOC/MTC (mobile originated/terminated call).



## Universal Radio Communication Tester R&S®CMU300

The optional A<sub>bis</sub> Board R&S®CMU-B71 is required for BER tests if the bit pattern sent by the R&S®CMU300 cannot internally be looped back by the base station.

### WCDMA

By adding the hardware option R&S®CMU-B76 (WCDMA Layer 1 Board) and the 3GPP FDD software option R&S®CMU-K76, the R&S®CMU300 is

converted into a source for all the required reference test channels up to 2048 kbps. For WCDMA TX measurements the options R&S®CMU-K75 and R&S®CMU-U75 must be fitted. The options GSM/EDGE and WCDMA can be installed independently of one another. If existing instruments are to be retrofitted, the option R&S®CMU-U76 must be ordered instead of R&S®CMU-B76.

The Software Option R&S®CMU-K77 provides an AWGN generator and the possibility to simulate bit errors. In this way more receiver tests according to specification 3GPP TS25.141 FDD can be performed.

Additional IQ/IF inputs/outputs (option R&S®CMU-B17) allow bit error rate measurements under fading conditions in conjunction with the R&S®SMIQ or R&S®ABFS.

### Specifications in brief

**You will find detailed and binding data on the enclosed CD (./DATASHEET/CMU300.pdf), or, for the latest updates, visit [www.rohde-schwarz.com](http://www.rohde-schwarz.com), search term: CMU300**

#### RF generator

Frequency range	100 kHz to 2700 MHz
Frequency resolution	0.1 Hz
Frequency uncertainty	same as timebase + resolution
Frequency settling time	<400 µs to Δf <1 kHz
<b>Output level range (RF1)</b>	
RF1	
100 kHz to 2200 MHz	-130 dBm to -27 dBm
2200 MHz to 2700 MHz	-130 dBm to -33 dBm
RF2	
100 kHz to 2200 MHz	-130 dBm to -10 dBm
2200 MHz to 2700 MHz	-130 dBm to -16 dBm
RF3 <sub>OUT</sub>	
100 kHz to 2200 MHz	-90 dBm to +13 dBm
2200 MHz to 2700 MHz	-90 dBm to +5 dBm

#### RF analyzer

<b>Power meter (frequency-selective)</b>	
Frequency range; resolution	10 MHz to 2700 MHz; 0.1 Hz
Resolution bandwidth	10 Hz to 1 MHz in 1/2/3/5 sequence
<b>Level range</b>	
RF1, continuous power <sup>1)</sup>	
10 MHz to 2200 MHz	-40 dBm to +47 dBm (50 W)
2200 MHz to 2700 MHz	-34 dBm to +47 dBm (50 W)
Peak envelope power <sup>2)</sup> (PEP)	+53 dBm (200 W)
RF2, continuous power	
10 MHz to 2200 MHz	-54 dBm to +33 dBm (2 W)
2200 MHz to 2700 MHz	-48 dBm to +33 dBm
Peak envelope power <sup>2)</sup> (PEP)	+39 dBm (8 W)
RF4 <sub>IN</sub> (continuous power and PEP)	
10 MHz to 2200 MHz	-80 dBm to 0 dBm
2200 MHz to 2700 MHz	-74 dBm to 0 dBm

<sup>1)</sup> 50 W (+5°C to +30°C), linear degradation down to 25 W at 45°C.

<sup>2)</sup> Mean value of power versus time must be equal or less than allowed continuous power.

#### Spectrum analyzer

Frequency range	10 MHz to 2.7 GHz
Span	zero span to full span
Frequency resolution	0.1 Hz
Resolution bandwidths (RBW)	10 Hz to 1 MHz in 1/2/3/5 sequence

#### General data

Operating temperature range	+5°C to +45°C
Storage temperature range	-25°C to +60°C
Display	21 cm TFT colour display (8.4")
Resolution	640 × 480 pixels (VGA resolution)
Power supply	100 V to 240 V ± 10% (AC), max. 500 VA, 50 Hz to 400 Hz -5% to +10%
Power consumption	
Base unit	130 W
With typical options	180 W
Dimensions (W × H × D)	465 mm × 193 mm × 517 mm, (19"; 4 HU)
Weight	
Base unit	14 kg
With typical options	18 kg

### Ordering information

<b>Radio Communication Tester</b>	R&S®CMU 300	1100.0008.03
<b>Accessories supplied</b>	power cord, operating manual, service manual	
<b>Options, software, modification kits, and extras</b>	see table on page before	

## Bluetooth® Testers R&S® CBT/CBT32

Fast and versatile for development, production and verification

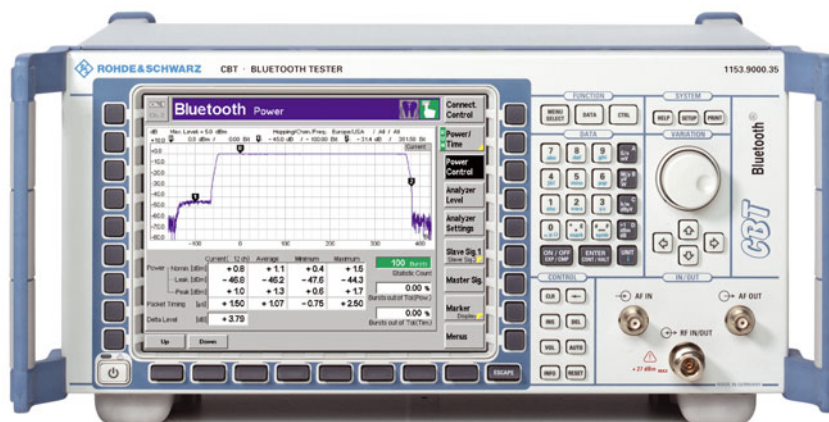

### Brief description

The *Bluetooth* Tester R&S® CBT offer a large number of statistical monitoring and measurement functions. It is compliant with the *Bluetooth* Core Specifications Version 1.1. The *Bluetooth* test mode (Core Spec. Part I:1) is implemented with all commands needed to perform the TX/RX measurements. In addition, the R&S® CBT is capable of testing all DUTs that support the new *Bluetooth* Core Specifications Version 1.2, since the test mode specified in the new version does not include any changes relevant to the R&S® CBT.

All remote scripts generated for the Bluetooth/signalling functional group of the R&S® CMU200 can also be used for the R&S® CBT and R&S® CBT32 without any modifications. The only prerequisite for compatibility is that in the R&S® CMU200 remote script one of the shared inputs/outputs RF1 or RF2 of the R&S® CMU200 is used for the measurement.

#### Setting up a Bluetooth connection

The R&S® CBT acts as the master of a *Bluetooth* piconet, the DUT as a slave. The R&S® CBT is able to perform the inquiry procedure for the identification of all *Bluetooth* devices within range of the

**Bluetooth Tester R&S® CBT with large display for R&D and production**

R&S® CBT. All devices found are listed on the display and one of them can be selected for the paging procedure. The R&S® CBT then establishes the connection to the DUT and switches it to test mode operation. The inquiry procedure can be skipped, if the *Bluetooth* device address of the DUT is already known.

#### Audio mode

In the audio mode, the R&S® CBT establishes a synchronous connection-oriented (SCO) link to the DUT in addition to the ACL link. The R&S® CBT's built-in *Bluetooth* audio codec supports CVSD as well as A-law and  $\mu$ -law coding. External audio generators and analyzers can be connected.

### Main features

- ◆ *Bluetooth* RF tests on all channels
- ◆ Full dirty transmitter for BER tests
- ◆ Speech codec integrated
- ◆ Cost-effective rack version R&S® CBT32 for production applications
- ◆ Very short cycle time for high production throughput

### TX measurements

The current measurement values for each parameter are displayed on the R&S® CBT screen. Additionally, average, maximum and minimum values are displayed as a result of a statistical evaluation of a definable number of *Bluetooth* packets (bursts).

#### Power measurements (output power)

- ◆ Nominal power (measured as the part of the burst starting at the detected first bit of the preamble (bit 0) to the last bit of the burst)
- ◆ Peak power (shows the highest power level within a burst)
- ◆ Leakage power (measured within defined areas before and after the burst)
- ◆ "Power up" and "Power down" commands
- ◆ Check the power control function of a *Bluetooth* DUT

#### Timing measurements

- ◆ Packet alignment (distance between ideal master receiver slot and detected bit 0 of the received burst)

## Bluetooth® Testers R&S® CBT/CBT32

### Modulation measurements

- ◆ Frequency accuracy/initial carrier frequency tolerance (ICFT, difference between measured frequency and intended transmitted frequency, measured in the preamble at the beginning of a packet)
- ◆ Carrier frequency drift (difference between the frequency at the start of the packet and the frequency in the payload)
- ◆ Maximum drift rate (maximum drift rate anywhere within the packet payload)
- ◆ Average, maximum and minimum frequency deviation (calculated over the packet payload)

### RX measurements

For RX measurements, the built-in signal generator generates a selectable bit sequence, which is looped back in the DUT and demodulated and processed by the R&S® CBT again. The TX level of the R&S® CBT can be adjusted for this measurement. The BER application allows up to five test programs to be defined. Each program can independently set settings such as control parameters, limits, repetition or statistical cycles.



*Bluetooth Tester R&S® CBT32: Cost-effective rack version of the R&S® CBT with identical features but without display*

### Sensitivity

- ◆ BER (percentage of bit errors that have occurred within the current statistical cycle)
- ◆ BER search function (sensitivity level for a predefined BER level)
- ◆ PER (percentage of packet errors that have occurred within the current statistical cycle)

### Dirty transmitter

- ◆ Dynamic dirty TX using the value table from the specification; drift superimposition switched on
- ◆ Dynamic dirty TX using a user-defined value table; drift superimposition either switched on or off
- ◆ Static dirty TX; the values for frequency offset, modulation index and symbol timing error can be set in any combination with respect to each other; drift superimposition either switched on or off

### Bluetooth RF test cases

The R&S® CBT and R&S® CBT32 can be used for the evaluation of the following *Bluetooth* test purposes as described in the *Bluetooth* RF test specification 0.92:

- ◆ TRM/CA/01/C (output power)
- ◆ TRM/CA/03/C (power control)
- ◆ TRM/CA/07/C (modulation characteristics)
- ◆ TRM/CA/08/C (initial carrier frequency tolerance)
- ◆ TRM/CA/09/C (carrier frequency drift)
- ◆ RCV/CA/01/C (sensitivity – single-slot packets)
- ◆ RCV/CA/02/C (sensitivity – multislots packets)
- ◆ RCV/CA/06/C (maximum input level)

## Specifications in brief

You will find detailed and binding data on the enclosed CD (../DATASHEET/CBT.pdf), or, for the latest updates, visit [www.rohde-schwarz.com](http://www.rohde-schwarz.com), search term: CBT

### RF generator

RF channel definition Bluetooth menu	2402 MHz + k × 1 MHz, k = 0 to 93
Frequency range	
RF menu	2398 MHz to 2499 MHz
Bluetooth menu	2402 MHz to 2495 MHz
Frequency resolution channel spacing according to standard	1 MHz
Frequency offset range	±250 kHz
Frequency offset resolution	1 kHz
Hopping scheme modes according to standard	Europe (except France), USA France RX/TX single frequency Reduced hopping
Output level range RF IN/OUT	−90 dBm to +0 dBm
Output level resolution	0.1 dB
Generator RF output level repeatability typical values after 1 h warmup time at constant ambient temperature	<0.03
Attenuation of harmonics RF IN/OUT	f <sub>0</sub> = 2398 MHz to 2499 MHz, up to 7 GHz >30 dB
Attenuation of nonharmonics	>50 dB
Modulation GFSK	1 Mbps, B × T = 0.5
Dirty TX	according to Bluetooth RF test specifications

### RF analyzer

RF channel definition Bluetooth menu	2402 MHz + k × 1 MHz, k = 0 to 93
Frequency range	
RF menu	2398 MHz to 2499 MHz
Bluetooth menu	2402 MHz to 2495 MHz
Frequency resolution channel spacing according to standard	1 MHz
Hopping scheme modes according to standard	Europe (except France), USA France RX/TX single frequency Reduced hopping

### Power meter (frequency-selective) and power versus time

Measurement bandwidth filter definition: passband Bluetooth menu Filter Bandwidth → wide Filter Bandwidth → narrow RF menu	2.0 MHz 1.3 MHz 10 Hz to 1 MHz in 1/2/3/5 steps
Level range RF IN/OUT continuous power peak envelope power <sup>1)</sup> (PEP)	−40 dBm to +22 dBm +26 dBm (300 mW)
Level resolution in manual mode in remote control mode	0.1 dB 0.01 dB

Reference level for full dynamic range RF IN/OUT continuous power peak envelope power <sup>1)</sup> (PEP)	GFSK signal −25 dBm to +22 dBm +26 dBm (300 mW)
Dynamic range Filter bandwidth → wide	>55 dB, rms
RF level measurement repeatability typical values after 1 h warmup time at constant ambient temperature	<0.03 dB
<b>Modulation analyzer</b>	
Measurement bandwidth filter definition: passband Filter Bandwidth → wide Filter Bandwidth → narrow	2.0 MHz 1.3 MHz
Level range RF IN/OUT	GFSK signal from full scale down to −25 dB
Total measurement range for frequency offset and frequency deviation	−250 kHz to +250 kHz
<b>Timing measurement</b>	
Range	±20 μs
Resolution	0.25 μs

<sup>1)</sup> Mean value of power vs time must be equal to or less than allowed continuous power.

### Interfaces

IEC/IEEE bus	IEC 60625-2 (IEEE 488.2)
Serial interface	COM 1 RS-232-C (COM)
Printer interface	LPT parallel (Centronics compatible)

### General specifications

Operating temperature range	+5°C to +45°C, meets EN 60068-2-1 and -2
<b>Power supply</b>	
Input	100 V to 240 V ±10% (AC), max. 220 VA, 50 Hz to 60 Hz, −5% to +10%
Power consumption R&S® CBT R&S® CBT32	approx. 60 W approx. 50 W
Display not included in model R&S® CBT32	21 cm TFT colour display (8.4") (VGA resolution)
<b>Dimensions W × H × D</b>	
R&S® CBT	411 mm × 193 mm × 317 mm (7/8 × 19"; 4 HU)
R&S® CBT32	465 mm × 93 mm × 417 mm (19"; 2 HU)
<b>Weight</b>	
R&S® CBT	approx. 7 kg
R&S® CBT32	approx. 6 kg

### Ordering information

<b>Bluetooth® Tester</b> with display, 4 HU	R&S® CBT	1153.9000.35
<b>Bluetooth® Tester</b> without display, 19", 2 HU, for remote control	R&S® CBT32	1153.9000.32

## Digital Radiocommunication Tester R&S®CMD57

**For production, installation and service of GSM900/1800/1900 base stations**

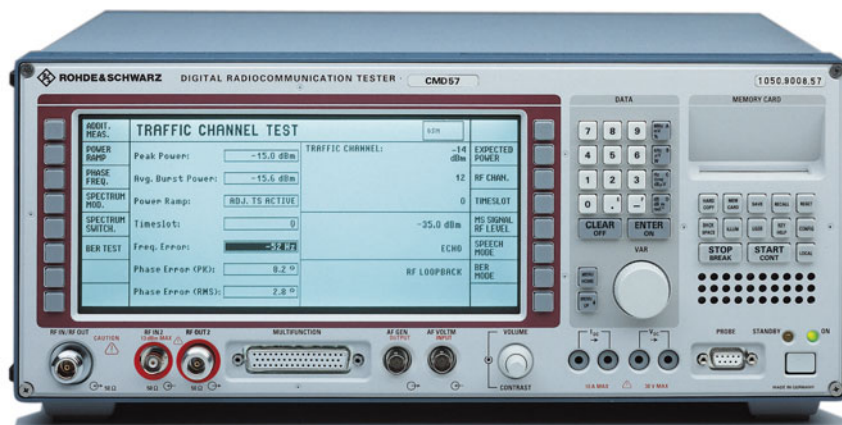

### Brief description

Digital Radiocommunication Tester R&S®CMD57 is designed for measurements in line with:

- ◆ GSM900
- ◆ GSM1800
- ◆ GSM1900 optionally
- ◆ E-GSM
- ◆ UIC – European train radiotelephony

The main applications are:

- ◆ Production
- ◆ Final testing
- ◆ Installation
- ◆ Service with test mobile functionality

R&S®CMD is the first compact radiocommunication tester worldwide allowing measurements on transmitters and receivers of base stations without affecting telephone calls in progress.

This tester combines compact size with high measurement accuracy and speed. It is suitable both for stationary and mobile use and feature great ease of operation and high reliability.

Operation is extremely easy and requires no detailed GSM knowledge. The high-contrast LCD display with softkeys on both sides allows menu-guided convenient callup of test routines.

### The key features at a glance

Characteristic/function	Benefit/application
<b>Transmitter measurements</b>	
Dynamic range >72 dB	Checking power ramps and output spectrum of BTS transmitter for compliance with the dynamic range specified by GSM
Measurement of power ramps	Checking the switching characteristics of the BTS transmitter
Phase and frequency error	Testing the modulation characteristics of the BTS transmitter including statistical function
Extremely fast measurement of spectrum due to modulation or switching	Detecting interference to the BTS transmitter at adjacent frequencies, due to modulation or switching
<b>Receiver measurements</b>	
Measurement of bit error rate (BER) via A <sub>bis</sub> /IEEE bus/RS-232-C interface, BTS loopback or R&S®CMD loopback	Testing the BTS receiver characteristics by adaptation to specific implementation in the BTS
Measurement of adjacent timeslot rejection with up to 50 dB higher level	Measuring the automatic gain control (AGC) of the BTS with high level difference between used and adjacent timeslot; simulation of different BTS receive levels
Level error <1 dB at -104 dBm	Reproducible and conclusive measurements even at low output levels especially at the sensitivity limits of the receiver
<b>Other measurements</b>	
Echo test	Subjective test of speech quality with call established
Module test	Complete transmitter measurements even without signalling or time synchronization
Multifunction RF generator	Ideal for alignment of receiver modules
DC current and voltage measurement	Optimized for pulsed signals; replaces external measuring instruments
AF measurement facilities and 60-MHz frequency counter (optional)	Replaces external frequency counter; ideal for measuring reference frequencies
RF monitor with bandwidths of 30, 100 kHz	Replaces external spectrum analyzer
Simulation of fading effects	On request



Contents Overview

Chapter Overview

Type Index

R&S Addresses



## Digital Radiocommunication Tester R&S®CMD57

Characteristic/function	Benefit/application
<b>Flexible use</b>	
Various BTS synchronization facilities as to time and frequency	Easy integration of measuring instrument into operational environment and problem-free adaptation to the specific synchronization signals of a BTS
Remote control via RS-232-C and IEC/IEEE bus	SCPI-compatible for easy generation of user-specific control programs
<b>Low cost of ownership</b>	
Software update via interface	No need to open the instrument; simple download of the latest software version via the RS-232-C interface
3 years of warranty	The optional warranty allows the instruments to be utilized at calculable costs

### Overview of options and extras

Designation	Brief description, recommendation	Option	Order No.
<b>I/Q Modulator Output</b>	For BER measurement on BTS receivers under conditions of fading (application note 1MA04_0E available on request). Generator/fading simulator R&S®SMIQ can be connected. Not useable with R&S®CMD-B8 and R&S®CMD-B2 together, but with R&S®CMD-B8 or R&S®CMD-B2 (only R&S®CMD59)	<b>R&amp;S®CMD-B17</b>	1099.3003.02
<b>GSM 1900 Base Station Test</b>	For testing GSM 1900 base stations	<b>R&amp;S®CMD-B19</b>	1059.6201.02
<b>OCXO Reference Oscillator</b>	For highly demanding requirements on frequency stability. Oven crystal with highest long-term stability. Aging $3.5 \times 10^{-8}$	<b>R&amp;S®CMD-B2</b>	1059.8604.02
<b>Reference Frequency Inputs/Outputs</b>	For synchronizing DUT and measuring instrument with internal or external frequencies	<b>R&amp;S®CMD-B3</b>	1051.6202.02
<b>AF Measurement Unit with Frequency Counter</b>	This option includes an AF generator, a voltmeter, a distortion meter and a frequency counter for measurements on the audio interface or on modules. R&S®CMD-B41 permits measurements up to 60 MHz as are required for LO alignment	<b>R&amp;S®CMD-B41</b>	1051.6902.02
<b>Realtime Speech Coder/Decoder</b>	This option converts digital speech signals into analog signals (and vice versa) (in conjunction with R&S®CMD-K1x, R&S®CMD-K30 or R&S®CMD-B8)	<b>R&amp;S®CMD-B52</b>	1115.8800.02
<b>Adapter for R&amp;S®CMD-B6x Options</b>	Required for operating the options R&S®CMD-B61 and R&S®CMD-B62	<b>R&amp;S®CMD-B6</b>	1051.7409.02
<b>IEC/IEEE bus Interface</b>	Alternative to standard RS-232-C interface for remote control of R&S®CMD	<b>R&amp;S®CMD-B61</b>	1051.7609.02
<b>Memory Card Interface</b>	Memory cards are a versatile medium for storing instrument settings	<b>R&amp;S®CMD-B62</b>	1051.8205.02
<b>A<sub>bis</sub> Interface</b>	For sensitivity measurements; required for A <sub>bis</sub> control. A <sub>bis</sub> card for BER measurements at this interface	<b>R&amp;S®CMD-B71</b>	1115.8500.02
<b>Modification Kit High-Level 2nd RF Output (9 dBm or 11 dBm)</b>	For off-air measurements. The standard output level range of the second output is approx. -35 dBm to -120 dBm; the level range +9 dBm/+11 dBm to -60 dBm is offered alternatively (not usable with R&S®CMD-U13)	<b>R&amp;S®CMD-U3</b>	1059.6501.02
<b>Handset</b>	Together with R&S®CMD-B8 + R&S®CMD-B5 allows to talk using R&S®CMD in the same way as a mobile	<b>R&amp;S®CMD-Z50</b>	1059.4250.02
<b>Transit Case</b>	Robust case for transport R&S®CMD with Rucksack R&S®CMD-Z40	<b>R&amp;S®ZZK-014</b>	1013.9595.00



Contents Overview

Chapter Overview

Type Index

R&S Addresses



## Digital Radiocommunication Tester R&S® CMD57

ADDIT. MEAS.	TRAFFIC CHANNEL TEST		DCF 1800	
POWER RAMP	Peak Power:	44.8 dBm	TRAFFIC CHANNEL:	45 dBm EXPECTED POWER
PHASE FREQ.	Avg. Burst Power:	44.4 dBm	RF Channel:	740
SPECTRUM MOD.	Power Ramp:	PASS	Timeslot:	0
SPECTRUM SWITCH.	Timeslot:	0		-35.0 dBm MS SIGNAL RF LEVEL
BER TEST	Freq. Error:	15 Hz		HANDSET SPEECH MODE
	Phase Error (PK):	7.2 °		RF LOOPBACK BER MODE
	Phase Error (RMS):	2.1 °		CALL RELEASE

After synchronization to the base station and setting up of a traffic channel, all relevant RF parameters are immediately measured and displayed; this menu also allows a quick change of channel, power and timeslot as well as setting of R&S® CMD transmission parameters

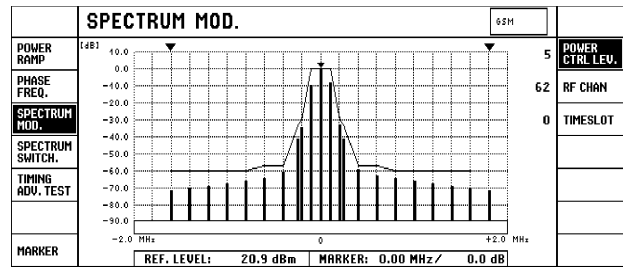

The spectrum due to modulation and switching can be measured in line with GSM specifications within a minimum of time and graphically displayed; the built-in marker function allows the digital value of each individual spectral line to be called up

SINGLE BER MEAS.	CONTINUOUS BIT ERROR RATE		GSM	
RESTART	CLASS	RBER	TRAFFIC CHAN. LEVEL:	-103.0 dBm USED TIMESLOT
	II	0.321 %	(relative to USED TS)	0.0 dB UNUSED TIMESLOT
	Ib	0.000 %		
	CLASS	FER		
	ERASED FRAMES	0.000 %		
	MS RECEIVER REPORTS			
	RxLev	9 (-102 to -101 dBm)		
	RxQual	1 (0.2 to 0.4 %)		
	CRC ERRORS:	0		
MEAS. MODE	BER	RBER		
AVERAGE	20 Frame	INDICATOR		

Sensitivity of a transceiver module of the base station is verified by means of a bit error rate (BER) test in RF loopback mode

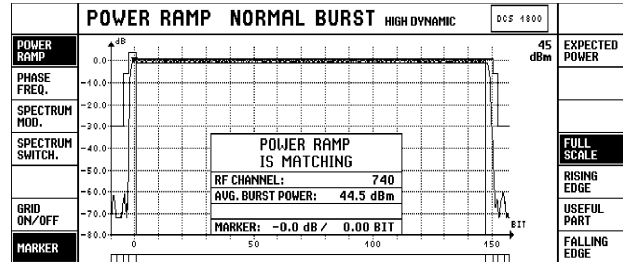

R&S® CMD 57 allows the power ramp to be measured with high dynamic range; with graphic display, the zoom function enables application-oriented resolution of parts of the displayed curve

### Specifications in brief

You will find detailed and binding data on the enclosed CD (./DATASHEET/CMD57.pdf), or, for the latest updates, visit [www.rohde-schwarz.com](http://www.rohde-schwarz.com), search term: CMD57

RF generator	
Frequency range	GSM900: 890.2 MHz to 914.8 MHz E-GSM900: 880.2 MHz to 890.0 MHz GSM1800: 1710.2 MHz to 1784.8 MHz GSM1900 <sup>1)</sup> : 1850.2 MHz to 1909.8 MHz
Resolution	GSM channel spacing 200 kHz
Settling time	<3 ms for phase error <2°
Output level (RF IN/OUT)/(OUTPUT 2)	-35(-37 <sup>1)</sup> ) to -120 dBm
Modulation	GMSK, B × T = 0.3
Phase error	<4° rms, <10° peak
Peak power meter (RF IN/OUT)	
Frequency range	800 MHz to 1000 MHz 1700 MHz to 1900 MHz
Measurement range	0 dBm to 47 dBm
Maximum RF power	47 dBm pulsed, 45 dBm CW 47 dBm CW at room temperature

Phase and frequency error measurement	
Frequency range	GSM900: 935.2 MHz to 959.8 MHz E-GSM900: 925.2 MHz to 935.0 MHz GSM1800: 1805.2 MHz to 1879.8 MHz GSM1900 <sup>1)</sup> : 1930.2 MHz to 1989.8 MHz
Level range	
RF IN/OUT	0 dBm to 47 dBm
RF IN 2	-57 dBm (-51 dBm <sup>1)</sup> ) to 0 dBm
Burst power measurement	
Frequency range	GSM900: 935.2 MHz to 959.8 MHz E-GSM900: 925.2 MHz to 935.0 MHz GSM1800: 1805.2 MHz to 1879.8 MHz GSM1900 <sup>1)</sup> : 1930.2 MHz to 1989.8 MHz
Reference level for full dynamic range	
RF IN/OUT	GSM900: 10 dBm to 47 dBm GSM1800/1900: 0 dBm to 47 dBm
RF IN 2	-37 dBm (-31 dBm <sup>1)</sup> ) to 0 dBm
High-dynamic burst analysis	
Relative error of individual test samples	≤1.5 dB to 72 dB below peak power
Dynamic range	>72 dB
Measurement limit RF IN/OUT	GSM900: <-36 dBm GSM1800: <-48 dBm GSM1900: <-42 dBm
Measurement limit RF IN 2	GSM: <-83 dBm GSM1800: <-85 dBm GSM1900: <-79 dBm

## Digital Radiocommunication Tester R&S® CMD57

GSM-specific measurements	
Spectrum due to modulation	
Test method	relative measurement, averaging
Resolution filter bandwidth	30 kHz
Measurement at an offset of	100/200/250/400/600/800/1000/1200/1400/1600 and 1800 kHz
Dynamic range	better than specified by GSM
for offset >400 kHz	max. 80 dB
Error	<±1.5 dB
Spectrum due to switching	
Test method	relative measurement, Max Hold over several measurements
Resolution filter bandwidth	30 kHz
Measurement at an offset of	400/600/1200 and 1800 kHz
Dynamic range	better than specified by GSM
for offset >400 kHz	max. 80 dB, with SW correction max. 76 dB, without SW correction
Error	≤1.5 dB (dynamic range <50 dBc) ≤2.5 dB (dynamic range 50 dBc to 80 dBc)
<b>Multi-Reference Frequency Inputs</b>	
Synchronization input	Output Option R&S®CMD-B3 GSM bit clock (270.8 kHz), 2/4/16 times GSM bit clock, 1 to 13 MHz in 1 MHz steps, 2.048/16.384/26/39/52 MHz
Synchronization output 1	10 MHz with internal reference or frequency at synchronization input with external reference
Synchronization output 2	GSM bit clock, 2/4/16 times GSM bit clock, 1/2/4 or 13 MHz
<b>A<sub>bis</sub> Interface</b>	
Receive channel (traffic/speech)	Option R&S®CMD-B7 75 Ω/high-impedance, unbalanced; 120 Ω/high-impedance, balanced; 16 kbit/s, timeslot selectable
<b>DC voltmeter</b>	0 V to ±30 V
<b>DC ammeter</b>	current averaging with GSM-adapted time constant, current peak measure- ment (maximum and minimum)
<b>Measurement range</b>	0 A to ±10 A
Common-mode rejection	±30 V
<b>AF Measurement Unit</b>	Option R&S®CMD-B41
<b>AF generator</b>	
Frequency range	50 Hz to 10 kHz
Level range	10 μV to 5 V
<b>AF voltmeter</b>	
Frequency range	50 Hz to 10 kHz
Measurement range	0.1 mV to 30 V
<b>Distortion meter</b>	
Frequency range	300 Hz to 3 kHz
Input level range	100 mV to 30 V
<b>AF counter</b>	
Frequency range	20 Hz to 10 kHz
Input level range	10 mV to 30 V
Resolution	≤1 Hz
<b>IF counter</b>	
Frequency range	10 kHz to 60 MHz
Input level range	100 mV rms to TTL
Resolution	1 Hz

<sup>1)</sup> In GSM 1900 mode with option R&S®CMD-B19 fitted.

### Multicarrier mode (Option R&S®CMD-B8)

The specifications apply to all cases, in which interfering carriers (up to 30 dB above useful level) are more than 30 GSM channels away. If there are interfering signals close to the useful carrier, an additional IF filter is switched in (multicarrier mode).

#### Typical filter characteristics in multicarrier mode

Offset from useful channel (kHz)	Filter suppression (dB)
0	0 (reference)
200	<3
400	>20
600	>33
800	>41
1000	>48

This filter increases the measurement error for phase and power measurements.

#### Phase and frequency error measurement

Inherent phase error ≤2° (rms), ≤7.5° (peak)

#### Measurement of peak power/burst power

Level error ≤1.5 dB

#### GSM-specific spectrum measurements

The dynamic range specified for the basic model refers to the sum of all input voltage components. The additional GSM carriers appear as strong spurious emissions in the spectrum measurement and have to be taken into account accordingly when evaluating the tolerances.

### General data

Rated temperature range	0°C to +45°C to DIN IEC 68-2-1/2
Storage temperature range	-40°C to +60°C
Power supply	100 V to 120 V AC ±10% 200 V to 240 V AC ±10% 50 Hz to 400 Hz ±5%
Power consumption (without options)	approx. 85 W
Dimensions (W × H × D)	435 mm × 192 mm × 363 mm
Weight (without options)	approx. 14 kg

### Ordering information

<b>Digital Radiocommunication Tester</b>	R&S®CMD57	1050.9008.57
<b>Accessories supplied</b>	power cable, operating manual, fuses	
<b>Options</b>	see overview of options on page 22	



## Universal Protocol Tester R&S®CRTU-G

**Protocol simulation and analysis at the GSM air interface (Um) for development and conformance testing of GSM terminal equipment**



### Brief description

#### Development of GSM mobiles

The R&S®CRTU-G simulates a GSM base station and records all messages sent to and received from a mobile station. This allows detailed analysis of the protocol stack in the mobile station. Protocol stack functions can also be modified by the user. So it is possible to simulate network errors, for instance, and analyze a mobile station's response. Parts of the protocol stack can be bypassed by appropriate programming. In this way, even protocol stacks implemented only partly in the mobile station can be tested.

#### Conformance testing of GSM mobiles

The conformance test of GSM mobiles is based on the test cases defined by 3GPP in specification 51.010. A large number of these test cases have been validated for Rohde&Schwarz by independent test houses and are available for the R&S®CRTU-G. Easy-to-use tools, automated testing and detailed log files speed up conformance testing and error elimination. Log files can be analyzed on a separate PC for the most efficient use of the R&S®CRTU-G.

*The message viewer clearly displays the message log file recorded during a test*

Additional conformance tests in line with user's own standards, e.g. network operators, can be implemented with the aid of user-defined tests.

#### Development of GSM chip sets

In the development of GSM chip sets, detailed analysis of customized test cases is as important as the requirement for several interfaces with the device under test, since an RF connection is not possible in all phases of development. The DUT can be contacted via analog I/Q and IF signals (option R&S®CRTU-B7).

#### Controlling further measuring instruments – multimode tests

The R&S®CRTU-G can assume controller functions in test systems comprising several measuring instruments. Control of further instruments via IEEE, COM or Ethernet can be incorporated in test programs.

#### Multicell/multichannel systems

Up to five R&S®CRTU-G testers can be interconnected for tests requiring more than two channels. Multichannel systems capable of handling even complex test scenarios are thus easily configured.

Dir	Name	phys.Channel	Base Station	log.Channel	Frame Number	Block
↓RX	DL-RA-Ind	1	1	RACH	3335	[13,20]
↓RX	EM-Service-Req	1	1	SDCCH	3406	[14,40]
↑TX	CM-Service-Accept	1	1	SDCCH	3493	[16,25]
↓RX	Register	1	1	SDCCH	3559	[17,40]
↑TX	SS-Release-Complete	1	1	SDCCH	3697	[20,25]
↑TX	Channel-Release	1	1	SDCCH	3952	[25,25]
↓RX	DL-Release-Ind	1	1	SDCCH	3967	[25,40]
↓RX	DL-RA-Ind	1	1	RACH	4211	[14,19]
↓RX	EM-Service-Req	1	2	FACCH	4769	[30,11]
↑TX	Authentication-Req	1	2	FACCH	4707	[31,3]
↓RX	Authent-Response	1	2	FACCH	4956	[37,16]
↑TX	Ciphering-Mode-Command	1	2	FACCH	4973	[38,7]
↓RX	Ciphering-Mode-Complete	1	2	FACCH	5025	[40,7]
↓RX	CC-Setup	1	2	FACCH	5051	[41,7]
↑TX	CC-Call-Proceeding	1	2	FACCH	5068	[41,24]
↑TX	Alerting	1	2	FACCH	5094	[42,24]
↑TX	CC-Connect	1	2	FACCH	5783	[18,11]
↓RX	CC-Connect-Ack	1	2	FACCH	5835	[20,11]
↓RX	EM-Service-Req	1	2	FACCH	7122	[18,24]
↑TX	CM-Service-Accept	1	2	FACCH	7140	[19,16]
↓RX	Register	1	2	FACCH	7222	[22,20]
↑TX	SS-Release-Complete	1	2	FACCH	7274	[24,20]
↑TX	CC-Disconnect	1	2	FACCH	7582	[36,16]
↓RX	CC-Release	1	2	FACCH	7630	[38,20]
↑TX	CC-Release-Complete	1	2	FACCH	7655	[39,11]



## Universal Protocol Tester R&S®CRTU-G

All channels are fully synchronized. RF signal routing and transmitter power control are already integrated in the testers so that no extra hardware is required. All testers are controlled via a single test application (see R&S®CRTU-S for more details).

### Tests under fading conditions using Baseband Fading Simulator R&S®ABFS

Using the optional I/Q/IF interface card, a baseband fading simulator (e.g. the R&S®ABFS) can be inserted into the signal path to perform fading tests on the DUT. Use of the R&S®CRTU-G frontend ensures high level accuracy.

### Main features

- ◆ Simulation of a GSM cell with two independent channels
- ◆ Up to four GSM timeslots per RF channel for GPRS
- ◆ Enhancement to multicell systems
- ◆ EDGE and software-controlled modulators/demodulators
- ◆ Predefined ETSI test cases available
- ◆ Platform for validated 3GPP 51.010 test cases
- ◆ Programming interface for user-defined tests
- ◆ Detailed analysis of messages at various protocol layers
- ◆ Customized solution can be further enhanced
- ◆ Individual software configuration
- ◆ High broadband RF accuracy
- ◆ Fit for the future
  - Upgradable to new standards
- ◆ Compact single-box, single-supplier solution with Windows2000 operating system
- ◆ Standard PC interfaces and software installation
- ◆ Easy and fast calibration
- ◆ Upgradable to WCDMA

### Tools

The tools supplied with the tester considerably facilitate routine work. For more efficient use of the tester, the tests can be pre- and postprocessed offline on a standard Windows PC, using optionally the tools described below.

- ◆ Configuration editor to generate basic information during the test
- ◆ Sequencer for the conformance test
- ◆ Message viewer for clear display of the message log file recorded during a test
- ◆ Message composer supports the programmer in easily composing the messages
- ◆ Hardware diagnostic tool confirms to the user proper functioning of the hardware modules in the R&S®CRTU-G

### GSM Phase 2+ Operational Software R&S®CR02P2P

The Operational Software R&S®CR02P2P contains the protocol stack and the channel/speech coders required to simulate a GSM base station. The protocol stack function can be modified in the test program to simulate faulty behaviour of the base station for instance. The individual entities of the protocol stack can be addressed separately. The operational software is continuously updated in line with modifications to 3GPP specifications. It comprises customary services and functions (not test cases), and optional services and functions can be installed. Detailed information on optional products can be found on Rohde&Schwarz's website.

### The tester comes with

- ◆ Speech HR/FR/EFR
- ◆ GMSK, 8PSK channel coder for EDGE
- ◆ Supplementary services
- ◆ ASCII
- ◆ Cell handover and multiband handover
- ◆ Ciphering
- ◆ BER measurements
- ◆ EGSM, RGSM

### That software options can be added

- ◆ GPRS including EDGE (incremental redundancy, link adaptation)
- ◆ AMR
- ◆ Circuit-switched single-slot data transfer NTDS (RLP)
- ◆ GSM850
- ◆ LCS

### Upgrade service

The GSM specifications forming the basis of the GSM operational software and of the test cases are subject to continuous updating. To ensure being always up-to-date, Rohde&Schwarz is offering a software upgrade service for the R&S®CRTU-G GSM software. Current information on all protocol test products is available under

[www.protocol-testing.rohde-schwarz.com](http://www.protocol-testing.rohde-schwarz.com).



## Universal Protocol Tester R&S®CRTU-G

### Specifications in brief

You will find detailed and binding data on the enclosed CD (./DATASHEET/CRTU-G.pdf), or, for the latest updates, visit [www.rohde-schwarz.com](http://www.rohde-schwarz.com), search term: CRTU-G

#### Inband GSM specifications

RF generator	
Modulation	GMSK, $B \times T = 0.3$ , 8PSK
Frequency range	GSM400/850 to GSM1900 band
Attenuation of inband spurious emissions	>50 dB
Inherent phase error (GMSK)	<1°, rms, <4°, peak
Inherent EVM (8PSK)	<2%, rms
Frequency settling time	<500 µs to res. phase of 4°
Output level range (GMSK)	-130 dBm to +5 dBm
Output level range (8PSK)	-130 dBm to +1 dBm
Output level uncertainty inband (+23°C to +35°C)	
RF1, RF2 at >-117 dBm	<0.7 dB
RF receiver	
Frequency range	GSM400/850 to GSM1900 band
Inherent phase error (GMSK)	<0.6°, rms, <2°, peak
Inherent EVM (8PSK)	<1.0%, rms
Reference level range for full dynamic range	
GMSK	-22 dBm to +53 dBm
8PSK	-26 dBm to +49 dBm

#### Base unit specifications

RF generator	
Frequency range	100 kHz to 2700 MHz
Frequency settling time	<400 µs to $\Delta f < 1$ kHz
Output level uncertainty (+23°C to +35°C)	
RF1, RF2	>-117 dBm
450 MHz to 2200 MHz	<0.8 dB
RF3 <sub>OUT</sub>	
450 MHz to 2200 MHz	<1.0 dB
Output level settling time	<4 µs
Generator RF level repeatability	
(RF1, RF2, RF3 <sub>OUT</sub> , typical values after 1 h warmup)	
Output ≥ -80 dBm	<0.01 dB
Attenuation of harmonics ( $f_0 = 10$ MHz to 2200 MHz, up to 7 GHz)	
RF1, RF2	>30 dB
RF3 <sub>OUT</sub> ( $P \leq +10$ dBm)	>20 dB
Attenuation of nonharmonics, 10 MHz to 2200 MHz, >5 kHz from carrier	>40 dB
Phase noise (single sideband, $f < 2.2$ GHz)	
Carrier offset ≥ 250 kHz	<-110 dBc (1 Hz)
Residual FM	
30 Hz to 15 kHz	<50 Hz (rms), <200 Hz (peak)
ITU-T	<5 Hz (rms)
Residual AM, ITU-T	<0.02% (rms)
I/Q modulation, data for frequency offset range 0 Hz to ±135 kHz	
Carrier suppression	>40 dB

RF receiver	
Phase noise (single sideband, $f < 2.2$ GHz)	
Carrier offset ≥ 400 kHz	<-118 dBc (Hz)
Residual FM	
30 Hz to 15 kHz	<50 Hz (rms), <200 Hz (peak)
CCITT	<5 Hz (rms)
Residual AM, CCITT	<0.02% (rms)
Power splitter (400 MHz to 2200 MHz)	
Insertion loss, SC/S1, SC/S2	<7 dB
Isolation, S1/S2	>17 dB
Max. continuous power	
SC	4 W
S1, S2	21 dBm
Inputs and outputs (rear panel)	
Remote control interface	IEC 625-2 (IEEE 488.2)
Serial interface COM1, COM2	RS-232-C (COM), 9-pin sub-D connector
Printer interface LPT	parallel (Centronics-compatible)
Mouse/keyboard connector	USB
Connector for ext. monitor (VGA)	15-pin sub-D connector
USB	double connector
Ethernet	RJ45

#### General data

Rated temperature range	+5°C to +45°C
Display	21 cm TFT colour display (8.4"), VGA
Power supply	100 V to 240 V ±10% (AC), 50 Hz to 400 Hz -5% to +10%
Power consumption	max. 500 W, base unit 200 W typ.
Dimensions (W × H × D); weight	465 mm × 193 mm × 517 mm (19"; 4 height units); 20 kg

### Ordering information

<b>Universal Protocol Tester</b>	R&S®CRTU-G	1140.0009.02
<b>Equipment supplied</b>		
Radio Unit	R&S®CRTU-RU	
Link Handler (2 pieces)	R&S®CRTU-B5	
MAC/Speech Board	R&S®CRTU-B6	
Test SIM Phase 2+	R&S®CRT-Z2	
Operational Software	R&S®CR02P2P	
<b>Accessories supplied</b>		
Hardlock		
<b>Option</b>		
2-channel I/Q/IF Interface Card	R&S®CRTU-B7	1139.0009.02

For information about software options, please contact the nearest Rohde&Schwarz office.

## Protocol Tester R&S®CRTU-S

**Cost-effective multibox and data application testing**

### Brief description

The R&S®CRTU-S enhances the R&S®CRTU-G by another R&S®CRTU radio unit with two additional RF channels. It is also suitable as a cost-effective stand-alone unit for data tests. Our service centers can upgrade any R&S®CRTU-S to an R&S®CRTU-G, if required.

### Conformance testing of GSM mobiles

The conformance test of GSM mobiles is based on the test cases defined by 3GPP in specification 51.010. Using an R&S®CRTU-G/R&S®CRTU-S multichannel solution, the test cases can be expanded to handover, cell selection and cell reselection as well as to other multichannel tests. A large number of these test cases have been validated for Rohde&Schwarz by independent test houses and are available for the R&S®CRTU-G. Easy-to-use tools, automated testing and detailed log files speed up conformance testing and error elimination.

### Main features

- ◆ Enhancement for multichannel tests on R&S®CRTU-G
- ◆ Platform for data application testing
- ◆ Simulation of a GSM cell with two independent channels
- ◆ Detailed analysis of messages at various protocol layers
- ◆ Fit for future mobile radio standards
- ◆ Upgradable to R&S®CRTU-G
- ◆ Cost-effective solution for multichannel tests
- ◆ Platform for reproducible data tests



- ◆ User-friendly network simulation for cost-saving application tests
- ◆ GSM 850, 900, 1800, 1900
- ◆ GPRS, EGPRS
- ◆ Message viewer for analysis of layer 1, 2, 3
- ◆ Layer 1 EDGE tool supporting all EDGE coding schemes
- ◆ Compact single supplier solution with Windows 2000 operating system
- ◆ Upgradable to R&S®CRTU-G

### Multibox scenarios

In conjunction with the R&S®CRTU-G, the R&S®CRTU-S is a cost-effective test solution for up to 10 RF channels. The R&S®CRTU-G simulates a GSM base station and records all messages sent to and received from a mobile station. This allows detailed analysis of the protocol stack in the mobile station even under complex multichannel conditions. The R&S®CRTU-S is entirely controlled by the R&S®CRTU-G and needs no additional control. One R&S®CRTU-G unit can control up to four R&S®CRTU-S units. The testers are interconnected via the integrated and calibrated RF combiners and TCP/IP cables. There is no need to

use external RF components. The messages of the protocol stack can be modified by the user. It is possible, for example, to simulate network errors and analyze a mobile station's response. To test partially implemented protocol stacks in the mobile, the R&S®CRTU-G allows sections of the stack to be bypassed.

### Data application testing

The R&S®CRTU-S is a cost-effective platform for application testing. Through the use of an additional software module for the R&S®CRTU-G/S units, the R&S®CRTU-S becomes a network simulator

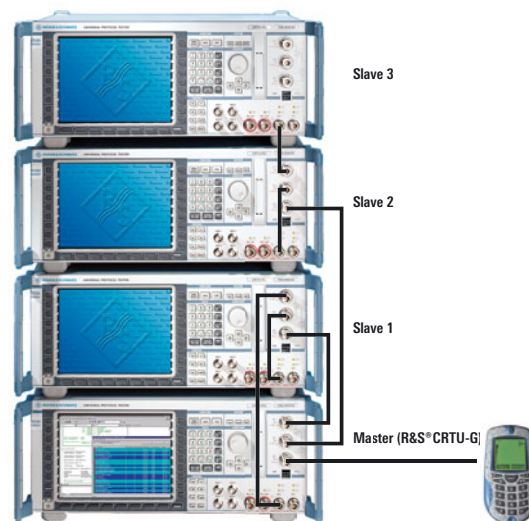

## Protocol Tester R&S® CRTU-S

that is able to enable services such as I-Mode, WAP, MMS, SMS and Internet access requested by mobile phone. Neither mobile radio nor programming

knowledge are thus required to test applications and their performance in the mobile phone. The reproducible conditions under which the mobile phone can

be tested are the only crucial factor. This application eliminates the need for dialling into a real network and thus the associated costs.

### Specifications in brief

You will find detailed and binding data on the enclosed CD (./DATASHEET/CRTU-S.pdf), or, for the latest updates, visit [www.rohde-schwarz.com](http://www.rohde-schwarz.com), search term: CRTU-S

#### Inband GSM specifications

RF generator	
Modulation	GMSK, B × T = 0.3, 8PSK
Frequency range	GSM400/850 to GSM1900 band
Attenuation of inband spurious emissions	>50 dB
Inherent phase error (GMSK)	<1°, rms, <4°, peak
Inherent EVM (8PSK)	<2%, rms
Frequency settling time	<500 µs to res. phase of 4°
Output level range (GMSK)	-130 dBm to +5 dBm
Output level range (8PSK)	-130 dBm to +1 dBm
Output level uncertainty inband (+23°C to +35°C)	RF1, RF2 at >-117 dBm <0.7 dB
RF receiver	
Frequency range	GSM400/850 to GSM1900 band
Inherent phase error (GMSK)	<0.6°, rms, <2°, peak
Inherent EVM (8PSK)	<1.0%, rms
Reference level range for full dynamic range	GMSK -22 dBm to +53 dBm 8PSK -26 dBm to +49 dBm

#### Base unit specifications

RF generator	
Frequency range	100 kHz to 2700 MHz
Frequency settling time	<400 µs to Δf <1kHz
Output level uncertainty (+23°C to +35°C)	RF1, RF2 at >-117 dBm
450 MHz to 2200 MHz	<0.8 dB
RF3 <sub>OUT</sub> (450 MHz to 2200 MHz)	<1.0 dB
Output level settling time	<4 µs
Generator RF level repeatability (RF1, RF2, RF3 <sub>OUT</sub> , typical values after 1 h warmup)	Output ≥-80 dBm <0.01 dB
Attenuation of harmonics (f <sub>0</sub> = 10 MHz to 2200 MHz, up to 7 GHz)	RF1, RF2 >30 dB RF3 <sub>OUT</sub> (P ≤+10 dBm) >20 dB
Attenuation of nonharmonics, 10 MHz to 2200 MHz, >5 kHz from carrier	>40 dB
Phase noise (single sideband, f <2.2 GHz)	Carrier offset ≥250 kHz <-110 dBc (1 Hz)
Residual FM	
30 Hz to 15 kHz	<50 Hz (rms), <200 Hz (peak)
ITU-T	<5 Hz (rms)

Residual AM, ITU-T	<0.02% (rms)
I/Q modulation, data for frequency offset range 0 Hz to ±135 kHz	Carrier suppression >40 dB
RF receiver	
Phase noise (single sideband, f <2.2 GHz)	Carrier offset ≥400 kHz <-118 dBc (1 Hz)
Residual FM	
30 Hz to 15 kHz	<50 Hz (rms), <200 Hz (peak)
CCITT	<5 Hz (rms)
Residual AM, CCITT	<0.02% (rms)
Power splitter (400 MHz to 2200 MHz)	
Insertion loss, SC/S1, SC/S2	<7 dB
Isolation, S1/S2	>17 dB
Max. continuous power	
SC	4 W
S1, S2	21 dBm
Inputs and outputs (rear panel)	
Remote control interface	IEC 625-2 (IEEE 488.2)
Serial interface COM1, COM2	RS-232-C (COM), 9-pin sub-D connector
Printer interface LPT	parallel (Centronics-compatible)
Mouse/Keyboard connector	USB
Connector for ext. monitor (VGA)	15-pin sub-D connector
USB	double connector
Ethernet	RJ45

#### General data

Display	21 cm TFT colour display (8.4"), VGA
Rated temperature range	+5°C to +45°C
Power supply	100 V to 240 V ±10% (AC), 500 VA, 50 Hz to 400 Hz -5% to +10% power factor correction, 200 W
Dimensions (W × H × D); weight	465 mm × 193 mm × 517 mm (19"; 4 height units); 20 kg

### Ordering information

Test equipment for Protocol verification of GSM Mobiles	R&S® CRTU-S	1140.0009.82
Equipment supplied		
Radio Unit	R&S® CRTU-RU	
Link handler (2 pieces)	R&S® CRTU-B5	
MAC/speech board	R&S® CRTU-B6	
Test SIM phase 2+	R&S® CRT-Z2	
Operational software	R&S® CRO2P2P	
Hardlock		
Option		
2-channel I/Q/IF interface card for R&S® CRTU-S	R&S® CRTU-B7	1139.0009.02

For information about software options, please contact the nearest Rohde & Schwarz office



Contents Overview

Chapter Overview

Type Index

R&S Addresses



## Protocol Tester R&S®CRTU-W

**Protocol test solution for 3G user equipment (UE)**



### Brief description

The R&S®CRTU-W is the unique signalling and protocol test solution for 3G and multimode terminals. This new member of the R&S®CRTU family provides the highest possible level of flexibility from early design and development through to comprehensive conformance and certification testing.

Powerful tools enable the user to define and execute TTCN test cases according to 3GPP test specification TS34.123, and to visualize the test results. In addition, customer-specific test scenarios can be implemented in TTCN or C++.

The message analyzer tool displays message logs in various formats (sequence, structured and detailed view) including parent/child message linking across protocol layers (incl. ASN.1 decoding).

Two independent RF channels allow the simulation of 2 WCDMA (FDD) cells at the same or at different RF frequencies, which is an indispensable prerequisite for performing WCDMA intrasystem handovers. Moreover, the R&S®CRTU-W is prepared for intersystem handover to GSM/GPRS systems, thus setting new standards in testing.

### Main features

- ◆ 2 RF channels/simulation of 2 WCDMA (FDD) cells
- ◆ Platform for official 3GPP signalling test cases acc. to TS34.123
- ◆ Implementation of test cases according to GCF priority
- ◆ Application testing
- ◆ Detailed analysis of all protocol layers at U<sub>i</sub> interface
- ◆ TTCN toolbox support
- ◆ C/C++ API for test script development
- ◆ Upgradable to GSM/GPRS
- ◆ Upgrading of existing R&S®CRTU-G to WCDMA possible
- ◆ Intersystem handover testing

### Characteristics

#### Medium level C++ application programming interface

The highly flexible medium level C++ application programming interface enables the user to create individual test scenarios. Embedded in an easy-to-use environment and offering a wide range of configuration options, it is particularly suitable for use in development.

#### Layer 1 test software option

The layer 1 test software option is the optimum solution for layer 1 testing of WCDMA user equipment. Providing a realtime downlink signal generator and a realtime uplink analyzer, the layer 1 test software option offers an intuitive graphical user interface and extensive configuration possibilities for physical and transport channels. Due to the high degree in flexibility, this tool is particularly suitable for testing HSDPA (high speed downlink packet access) capable user equipment.

#### High speed downlink packet access (HSDPA)

The R&S®CRTU-W supports layer 1 as well as full UTRAN protocol testing for high speed downlink packet access (HSDPA)<sup>1)</sup> according to 3GPP release 5.

Based on this functionality, conformance and application testing for HSDPA are supported. Example signalling scenarios for HSDPA are provided by means of the flexible medium level C++ interface.

<sup>1)</sup> Feature not yet released, for more details contact customersupport@rohde-schwarz.com



Contents Overview

Chapter Overview

Type Index

R&S Addresses



## Protocol Tester R&S®CRTU-W

### R&S®CRTU-W Tools

The R&S®CRTU-W contains a complete tool chain satisfying all requirements such as test case management, test case modification, test session configuration as well as full analysis of the test results.

Since the tools are implemented in Java, they can be installed on any operating system. For full analysis of the test results and configuration of test sessions, the complete tool chain is also available offline. So the R&S®CRTU-W can effectively be used for WCDMA protocol testing.

### Project Explorer

The Project Explorer contains full functionality for configuring test sessions. With the aid of the Project Explorer, test cases for a test session can be selected from a test suite. Complete regression tests can be generated by combining test cases from different test suites.

In addition to handling test cases, the Project Explorer can be used to configure the hardware or reference implementations. The Project Explorer also controls the complete run of the test session.

While a test session is running, the Project Explorer displays online the current status of the complete test session and of the individual test cases. Immediately upon completion of a test case, the final verdict of that test case is displayed.

### Message Analyzer

Thanks to the mature architecture of the R&S®CRTU-W software, all messages sent via the service access points in line with 3GPP specifications can be stored in a central log file. The decoding function

of the Message Analyzer ensures convenient analysis of this information.

Another powerful feature of the Message Analyzer is the message sequence chart. The Message Analyzer allows all messages to be displayed in a message sequence chart in conformity with official specifications. This function makes it very easy for the user to analyze the logic data flow within a test case.

### Test Case Analyzer

The Test Case Analyzer allows analysis of the automatically generated test case result file. This file contains all information about the messages sent or received by the test case, as well as all information about timer and configuration. The TTCN

Editor can be started with a hyperlink during the analysis. The corresponding TTCN source code is displayed within the TTCN Editor. Full and in-depth analysis of the test case result file is possible.

### TTCN Editor

In addition to the tools developed by Rohde&Schwarz, the TTCN Editor Leonardo from Da Vinci Communications Ltd is available in the R&S®CRTU-W tool chain. The TTCN Editor enhances the analysis functions of the Test Case Analyzer and enables simple modification of existing test cases or generation of new ones. The TTCN Editor comprises an integrated version manager allowing the use and management of different versions of a test suite.

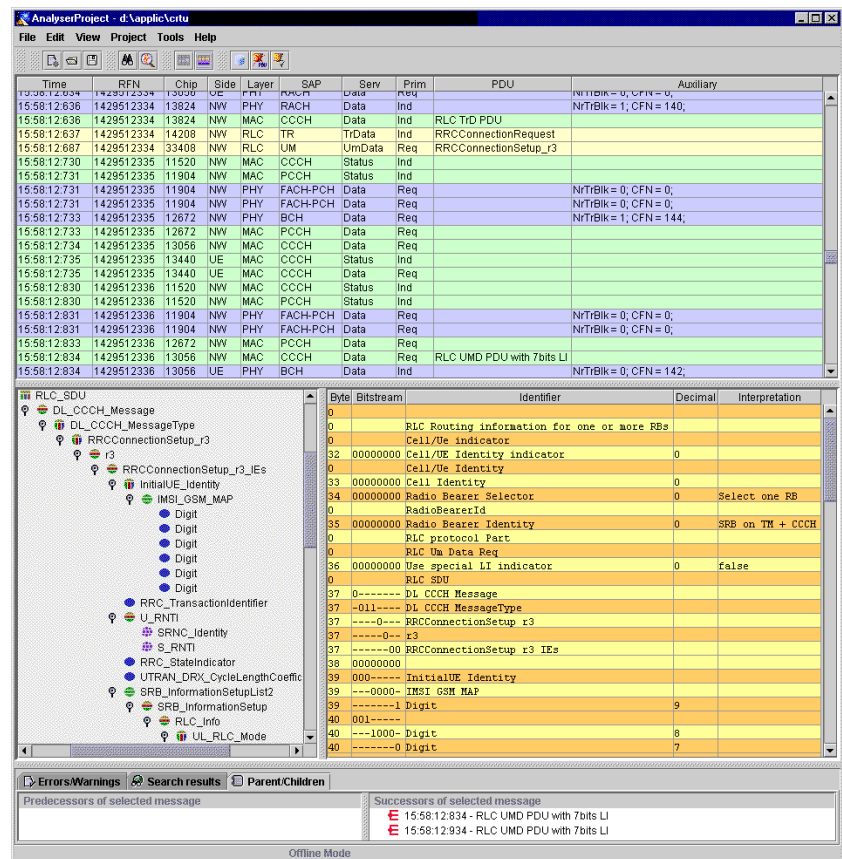

## Protocol Tester R&S®CRTU-W

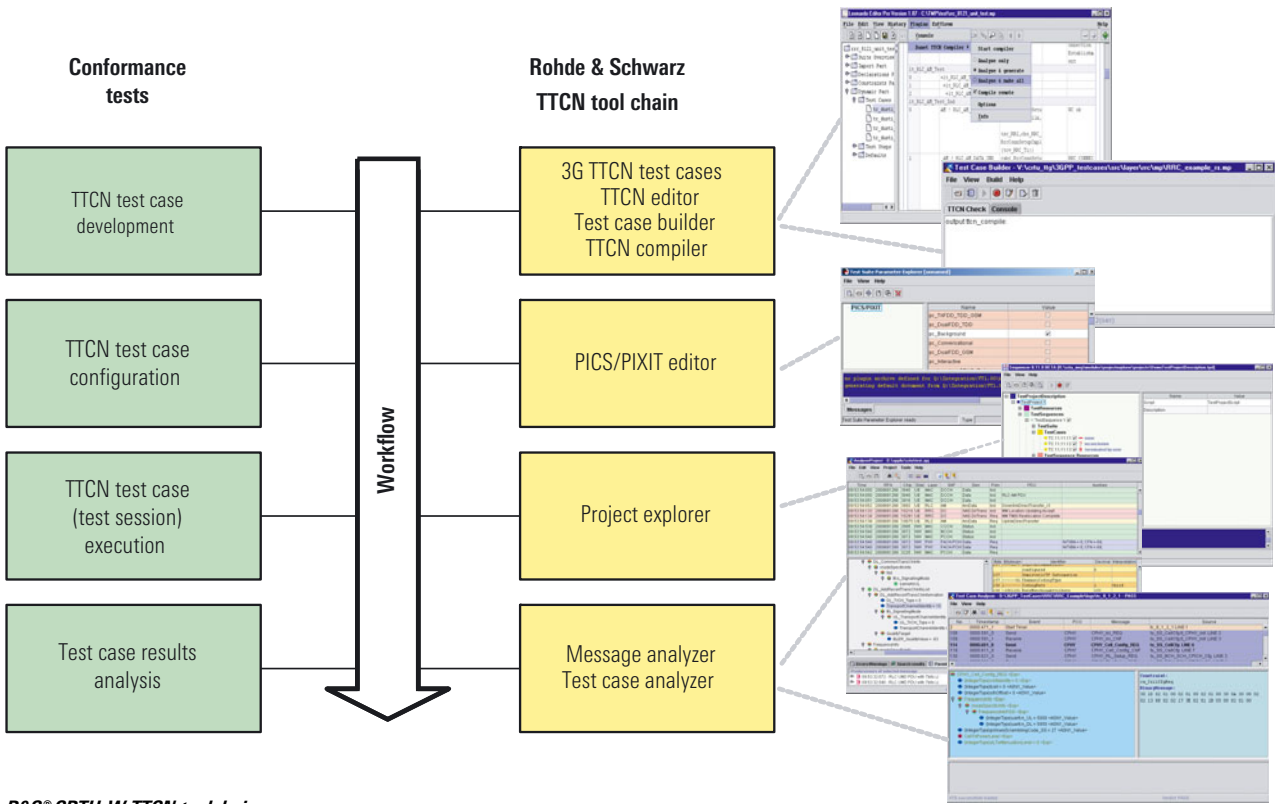

*R&S®CRTU-W TTCN toolchain*

### Technical details

#### RF

- ◆ Two independent RF channels
- ◆ Simulation of 2 cells on same or different frequency
- ◆ RF frequency range: 10 MHz to 2.7 GHz
- ◆ 3.84 Mchip/s

#### DL physical channels

- ◆ Up to 16 physical channels in parallel per cell
- ◆ CPICH
- ◆ P-/S-SCH
- ◆ P-CCPCH
- ◆ S-CCPCH
- ◆ PICH

- ◆ AICH
- ◆ n \* DPCH + OCNS with m channels
- ◆ HS-PDSCH
- ◆ Power level can be set for each physical channel separately

#### UL physical channels

- ◆ PRACH
- ◆ DPCCCH
- ◆ 6 \* DPDCH

#### Physical layer – transport channels

- ◆ DL transport channels
  - BCH, PCH, FACH
  - Up to 8 DCH with 384 kbit/s (single code and multicode) Service multiplexing
  - HS-DSCH

- ◆ UL transport channels
  - RACH
  - Up to 8 DCH with 384 kbit/s (single code, service multiplexing)

#### Reference implementations of

- ◆ MAC
- ◆ RLC
- ◆ RRC



## Protocol Tester R&S®CRTU-W

### Specifications in brief

You will find detailed and binding data on the enclosed CD (./DATASHEET/CRTU-W.pdf), or, for the latest updates, visit [www.rohde-schwarz.com](http://www.rohde-schwarz.com), search term: CRTU-W

<b>Standard</b>	
Standard	3GPP-FDD, 3.84 Mcps
<b>RF Generator</b>	
Modulation	According to standard 3.84 MHz RRC, $\alpha = 0.22$
Frequency range	2110 MHz to 2170 MHz
Channel spacing	5 MHz
Channel raster	200 kHz
<b>RF Receiver</b>	
Demodulation	Receiver filter according to standard 3.84 MHz RRC, $\alpha = 0.22$
Frequency range	1920 MHz to 1980 MHz
Channel spacing	5 MHz
Channel raster	200 kHz

### General data

<b>Radio Unit R&amp;S®CRTU-PU</b>	
Operating temperature range	+5°C to +45°C

<b>Radio Unit R&amp;S®CRTU-RU</b>	
<b>Power supply</b>	100 V to 240 V 10% (AC), 500 VA, 50 Hz to 400 Hz -5% to +10%
Power consumption	Approx. 160 W
Dimensions (W × H × D)	465 mm × 193 mm × 517 mm, 19", 4 height units
Weight	Approx. 18 kg

<b>Protocol Unit R&amp;S®CRTU-PU</b>	
<b>Power supply</b>	100 V to 120 V 10% (AC) or 220 V to 240 V 10% (AC), 600 VA, 50 Hz to 60 Hz -5% to +10%
Power consumption	Approx. 180 W
Dimensions (W × H × D)	465 mm × 238 mm × 617 mm, 19", 5 height units
Weight	Approx. 21 kg

### Ordering information

<b>Test Equipment for Protocol Verification of WCDMA Mobiles</b>	
Included in package: Radio Unit R&S®CRTU-RU (incl. R&S®CRTU-B7), Protocol Unit R&S®CRTU-PU, hardlock, Operational Software R&S®CRTUW001, spare fuses (two for Protocol Unit)	
R&S®CRTU-W	1140.0509.02

<b>Recommended accessories</b>		
Antenna Coupler for Handheld Telephones	R&S®CMU-Z10	1150.0801.02
Shielded Chamber for R&S®CMU-Z10	R&S®CMU-Z11	1150.1008.02
19" Rack Adapter (for Radio Unit)	R&S®ZZA-411	1096.3283.00
19" Rack Adapter (for Protocol Unit)	R&S®ZZA-511	1096.3290.00

## Digital Radio Testers R&S® CTS55/60/65 for mobile phones

**New**  
Now for  
GSM850!

Tester family for fast and conclusive GSM/GPRS and DECT measurements in service

Digital Radio Tester R&S® CTS65

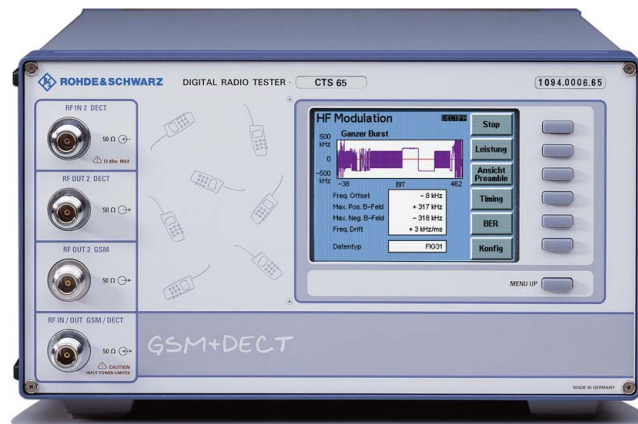

### Brief description

Digital Radio Tester R&S® CTS from Rohde & Schwarz comes in three models:

- ◆ **R&S® CTS55**  
for mobile phones to GSM850/900/1800/1900
- ◆ **R&S® CTS60**  
for DECT phones (portable part and fixed part)
- ◆ **R&S® CTS65**  
for GSM and DECT

Digital Radio Tester R&S® CTS is an extremely compact, modular yet powerful measuring instrument. It combines great ease of operation and the necessary test depth for use in all service areas for GSM/GPRS mobile and DECT cordless phones: from a simple functional test to repairs. Both the newcomer and the service specialist will be able to conveniently carry out fast automatic functional tests as well as complex and comprehensive manual measurements down to component level.

### Main features

- ◆ User-friendly menu-guided control via softkeys

- ◆ Logical user prompting without interleaved submenus
- ◆ Brilliant TFT colour display: an own dimension in this class of instruments
- ◆ operating menus in seven different languages
- ◆ Compact and robust design, low weight
- ◆ Eye-strain-free working
- ◆ Dynamic range for measuring the power ramp: GSM >55 dB, DECT >60 dB
- ◆ Built-in reference oscillator TCXO or OCXO (option R&S® CTS-B1)
- ◆ Combined RF input/output for GSM and DECT
- ◆ DECT off-air measurements via additional input/output
- ◆ Remote control via RS-232-C (option R&S® CTS-K6)
- ◆ Location update
- ◆ Call setup (incoming/outgoing)
- ◆ Call clear-down (incoming/outgoing)
- ◆ Dualband handover
- ◆ Control and measurement of transmitter power
- ◆ Access class control
- ◆ Handover (channel change)
- ◆ Sensitivity
  - Bit error rate BER and RBER
  - RxLev and RxQual
- ◆ Phase and frequency error
- ◆ Power ramp versus time
- ◆ Timing error
- ◆ Echo test (voice test, includes also testing of loudspeaker and microphone)
- ◆ Function test of mobile's keypad through display of dialled number
- ◆ Display of
  - IMSI (international mobile subscriber identity)
  - IMEI (international mobile equipment identity)
- ◆ AM suppression (only with option R&S® CTS-K7)

### GSM measurement functions

R&S® CTS55 simulates a GSM base station for testing mobile phones. The following measurements and tests can be performed by automatic test routines or manually.

- ◆ Synchronization of mobile phone with base station (which is simulated by R&S® CTS)

### GPRS

The R&S® CTS also supports GPRS-compatible mobile phones. The R&S® CTS-K4 signalling option will make

## Digital Radio Testers R&S® CTS55/60/65 for mobile phones

it possible to perform a GPRS attach/detach as well as block error rate (BLER) measurements in a timeslot.

- ◆ Attach/detach
- ◆ BLER measurement

### DECT measurement, test and adjustment capabilities

- ◆ Synchronization of DUT with the R&S® CTS
- ◆ Call setup
- ◆ Call release
- ◆ Echo test
- ◆ Detection and display of RFPI (FP)
- ◆ Normal transmit power (NTP)
- ◆ Power ramp versus time
- ◆ Modulation characteristics versus time
- ◆ Frequency offset
- ◆ Maximum modulation deviation
- ◆ Frequency drift
- ◆ Timing (jitter, packet delay)
- ◆ Bit error rate (BER), frame error rate (FER)

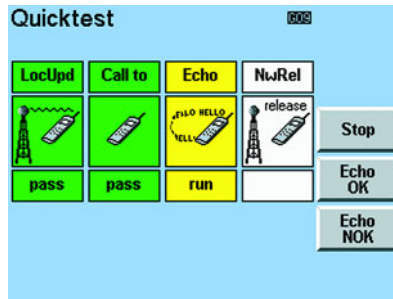

The quick test provides an extremely fast Go/NoGo information covering all essential parts of the mobile phone. A speech test (echo test) is carried out immediately after the call setup (GSM)

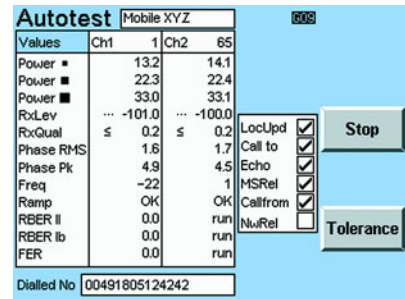

The autotest routines allow complete functional tests to be started at a keystroke. The tests cover all essential signalling functions as well as the transmitter and receiver characteristics of the mobile phone (GSM)

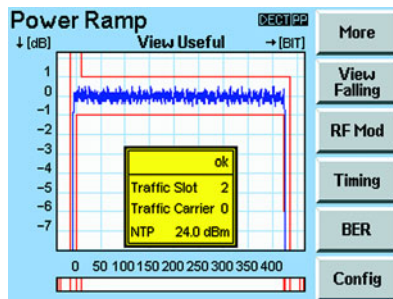

The R&S® CTS measures the power ramp of the signal sent by an FP or PP with a dynamic range of >60 dB (DECT)

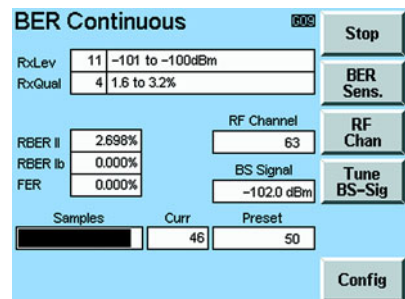

The BER is an essential criterion for evaluating the receiver characteristics of the mobile phone. The CTS measures these characteristics with the aid of various test routines such as RBER (class Ib; II; FER) and BER (class Ib; II) (GSM)

### Specifications in brief

You will find detailed and binding data on the enclosed CD (./DATASHEET/CTS.pdf), or, for the latest updates, visit [www.rohde-schwarz.com](http://www.rohde-schwarz.com), search term: CTS

#### GSM

GSM signal generator	
Frequency range	GSM850 to GSM1900 bands
Resolution	GSM channel spacing 200 kHz
Output level	
RF IN/OUT with 0 dB ext. attenuation	-50 dBm to -110 dBm
RF OUT2 GSM with 0 dB ext. attenuation	-15 dBm to -75 dBm
Level error RF IN/OUT	≤1.5 dB
Modulation	GMSK, B × T = 0.3
Narrowband Spectrum Monitor Option R&S® CTS-B7	
Span	300 kHz
Resolution bandwidth	4/10/20/50/100 kHz
Dynamic range	(P >5 dBm) typ. 50 dBc
Markers	3 markers and delta-marker

GSM peak power meter	
Frequency range	GSM850 to GSM1900 bands
Measurement range	
with 0 dB ext. attenuation	-20 dBm to +39 dBm (peak values up to 41 dBm)
with 15 dB ext. attenuation	0 dBm to +39 dBm (peak values up to 41 dBm)
GSM measurement of phase and frequency error	
Frequency range	GSM850 to GSM1900 bands
Level range	-15 dBm to 39 dBm (peak values up to 41 dBm)
GSM measurement of burst power	
Frequency range	GSM850 to GSM1900 bands
Reference level for full dynamic range with 0 dB ext. attenuation	0 dBm to +39 dBm (peak values up to 41 dBm)
Dynamic range (P >5 dBm)	≥55 dB
Resolution	0.1 dB

## Digital Radio Testers R&S® CTS55/60/65 for mobile phones

### DECT

<b>DECT signal generator</b>	
Frequency range	1876.608 MHz to 1935.360 MHz and half channels
Frequency drift	same as reference oscillator
<b>Output level</b>	
RF IN/OUT	-100 dBm to -40 dBm
RF OUT2 DECT	-40 dBm to 0 dBm (-20 dBm to 0 dBm if RF IN2 DECT is active), useable up to 5 dBm
Level error RF IN/OUT	≤1.5 dB
Modulation	GFSK (B × T = 0.5)
<b>DECT analyzer</b>	
Frequency range	same as signal generator
Measurement range	with 0 dB external attenuation
RF IN/OUT	30 dBm to -30 dBm
RF IN2 DECT	-35 dBm to -55 dBm
<b>FM demodulator</b>	
Frequency range	0 Hz to 450 kHz
Resolution	1 kHz
DC offset	<3 kHz
<b>Residual FM</b>	
RF IN/OUT (30 dBm to 15 dBm)	<5 kHz, peak, 95% confidence
RF IN2 DECT (-35 dBm to -40 dBm)	<5 kHz, peak, 95% confidence
<b>Level meter</b>	
Range	30 dBm to -55 dBm
Dynamic range	60 dB (for P = 24 dBm)
Resolution	0.5 dB
<b>Accuracy</b>	
RF IN/OUT	<1 dB + resolution (30 dBm to 5 dBm) <2 dB + resolution (<5 dBm)
RF IN2 DECT	<2 dB + resolution (-35 dBm to -51 dBm) <2.5 dB + resolution (<-51 dBm)
<b>Audio Interface</b>	
Output	
Range	558 mV, 300 Hz to 3 kHz
S/N + THD	30 dB at max. level
Passband ripple	0.5 dB
Input	
Range	80 mV, 300 Hz to 3 kHz
S/N + THD	35 dB at max. level
Passband ripple	0.5 dB
DECT applications	averaging 10 bursts
<b>Modulation section 1, 2, 4</b>	
Error	approx. 11 kHz with min. (202 kHz) permissible deviation approx. 13 kHz with max. (403 kHz) permissible deviation
Frequency drift	approx. 1 kHz/ms (over 200 bursts)
<b>Transmit power</b>	
Measurement accuracy	
RF IN/OUT	<1 dB + resolution (30 dBm to 5 dBm) <2 dB + resolution (<5 dBm)
RF IN2 DECT	<2 dB + resolution (-35 dBm to -51 dBm) <2.5 dB + resolution (<-51 dBm)

### General data

VSWR at all RF connectors	≤1.5
Rated temperature range	+5°C to +40°C
Operating temperature range	0°C to +45°C
Storage temperature range	-25°C to +60°C
Power supply	200 V to 240 V AC ±10%, 100 V to 120 V AC ±10%, 50 Hz to 60 Hz ±5%
Power consumption	approx. 60 W
Dimensions (W × H × D)	319 mm × 177 mm × 350 mm
<b>Weight</b>	
R&S®CTS55, R&S®CTS60	approx. 7.8 kg
R&S®CTS65	approx. 8.8 kg

### Ordering information

<b>Digital Radio Tester</b>		
GSM	R&S®CTS 55	1094.0006.55
DECT	R&S®CTS 60	1094.0006.60
GSM and DECT	R&S®CTS 65	1094.0006.65
<b>Options</b>		
OCXO Reference Oscillator Aging $0.2 \times 10^{-6}$ /year	R&S®CTS-B1	1079.0809.02
GPRS Signalling	R&S®CTS-K4	1079.1905.02
GSM Remote Control (with Application Software for Windows)	R&S®CTS-K6	1079.2001.01
GSM Module Test	R&S®CTS-K7	1079.2501.02
GAP Signalling	R&S®CTS-K62	1079.2601.01
<b>Extras</b>		
Universal shielded Chamber	R&S®CTS-Z12	1079.1470.02
Antenna Coupler	R&S®CMU-Z10	1150.0801.02
RF Shielding Cover for R&S®CMU-Z10	R&S®CMU-Z11	1150.1008.02
DECT-Antenna with N connector		1086.3116.00
GSM Test SIM	R&S®CRT-Z2	1039.9005.02
Compact keyboard		
German	R&S®PSP-Z1	1091.4000.02
US	R&S®PSP-Z2	1091.4100.02
Production Calibration	R&S®DCV-1	0240.8733.08
Service Manual		1094.3405.24

## DECT Tester R&S®CMD60

**Speedy and cost-effective measurements on DECT communications devices**

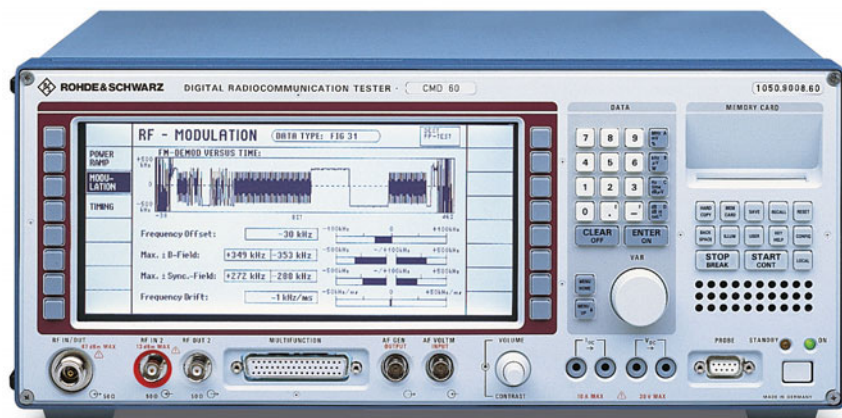

### Brief description

Reliability, measurement speed and cost effectiveness are the characteristics a test equipment must have to succeed in the field of the widely used DECT communication devices.

The great experience gained with preceding DECT measurement instruments such as signal generators, analyzers, communication testers and DECT type-approval systems as well as cooperative development work with several key end-users have contributed towards creating a well-balanced tester for production and service according to all aspects.

### Benefits at a glance

#### Production

- ◆ The R&S®CMD60 can be remote controlled via the RS-232-C or IEC/IEEE bus interface using SCPI-compatible commands. In the remote-control mode R&S®CMD60 is designed for fast speed to yield high throughputs in production
- ◆ High production output at low investment for test equipment
- ◆ Comprehensive test capabilities implemented in one single unit

#### Development

- ◆ Comprehensive in-depth measurements under a convenient user interface
- ◆ A lot of complex test setups with conventional equipment become redundant with the use of this special DECT tester
- ◆ Automatic regression and stress tests
- ◆ The tester supplies a great number of DECT-specific signals such as bit clock, TX/RX enable, to control the module under test

#### Servicing

- ◆ Relaxed manual operation due to a large bright LCD in conjunction with an extremely simple user interface (requires no DECT-specific knowledge) strictly separated from the expert user interface for configurations
- ◆ Integrated tools such as a scope display for power and FM demodulation versus time ease troubleshooting

### Main features

- ◆ For production, service and development
- ◆ RF measurements to CTR06
- ◆ Comprehensive audio tests
- ◆ Extremely fast measurements for high production throughput

- ◆ Ergonomic user interface for service applications
- ◆ Selfcontained, lightweight, compact tester

### Menu structure

The power ramp measurement permits in-depth analysis of the burst power transmitted by the FP or PP. The measurement is synchronized to bit P0, thus giving precise information not only about the power transmitted but also about timing parameters.

The RF modulation measurement menu presents the demodulated signal in a scope display for easy and quick recognition of typical data forms, and accurate measurement results as numbers and bargraphs for further analysis.

Timing parameters such as the absolute timing accuracy as well as the jitter between two bursts are measured and displayed in an easy-to-read format.

User-defined tolerances for parameters like BER, modulation, timing, power and power ramp (burst) as are shown here can easily be entered via the configuration menu. If any of the set limits are exceeded, the measurement will be shown in inverse video for easy identification.

## DECT Tester R&S®CMD60

The module test offers RF signal generator and RF burst analyzer features for testing DECT modules without signalling, i.e. when troubleshooting or adjustments are required.

### Interface description

#### R&S®CMD60 transmitter part

In a very busy DECT environment most DECT frequencies may be in use for communication and therefore influence the measurement in production and development. Besides the channels 0 to 9 the R&S®CMD60 enables the use of an extended frequency range for testing. Channels -3, -2, -1 and 10, 11, 12 are outside the normal DECT specification and therefore free for testing.

The DECT standard requires two levels: -83 dBm and -73 dBm. The R&S®CMD60 provides an extra level range of up to 30 dB to overcome external coupler and cable attenuation.

The R&S®CMD60 provides 1 up to 12 consecutive TDMA slots for rapid BER measurements for PP tests (2 slots for FP test). The measuring time in production can be considerably cut down if more than one timeslot is used for BER measurements.

Modulation is GFSK with  $B \times T = 0.5$  according to DECT specifications. In addition, constant envelope, signals with or without modulation or DECT bursts with various bit patterns for module test are possible.

These bit patterns can easily be recognized while testing receiver and demodulator modules.

#### R&S®CMD60 receiver part

It is similar to the transmitter part above: there are 10 DECT frequency channels No. 0 to 9. Additionally, 6 extended DECT frequency channels No. -3, -2, -1 and 10, 11, 12 in DECT channel spacing are provided.

Should the standard DECT output level of 24 dBm be attenuated due to couplers and cable attenuation, the R&S®CMD60 provides more than 30 dB measurement range.

There are two independent receive paths: For DECT signalling and BER a signalling path is incorporated in the R&S®CMD60. For TX tests the R&S®CMD60 provides a measurement path. The FM and envelope detector are both taken to external connectors and post-processed for power ramp and modulation measurements. The FM and envelope detector output permits monitoring of the DUT transmit signal.

#### RF input/output

The R&S®CMD60 transmitter and receiver are connected to a bidirectional N connector (RF in/out). All mentioned specifications are valid for this connector. Moreover, there is a high-level output for the R&S®CMD transmitter (level range like N connector + approx. 40 dB) as well as a high-sensitivity input for the R&S®CMD receiver on the front panel.

#### Demodulator interface

R&S®CMD60 provides a linear, analog FM demodulator output (DC-coupled) and a logarithmic analog RF envelope demodulator output (DC-coupled).

#### Wideband input/output

The second wideband input/output (100 MHz to 2.5 GHz) is on the rear panel. The input signal from the front connector is provided at this connector with an attenuation of 12 dB. It can be monitored with a spectrum analyzer for spurious measurements. Furthermore, this connector can be used to introduce an interferer into the RF connection without reconnecting the test setup for the in-channel tests.

#### R&S®CMD60 audio part

In addition to the DECT RF interface on the R&S®CMD60 front panel, there is an analog DECT voice interface for a speaker and the appropriate microphone (analog ADPCM interface). Alternatively it can be connected to the AF Measurement Unit R&S®CMD-B41.

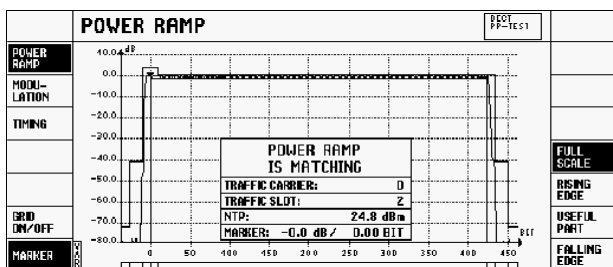

Power ramp measurement

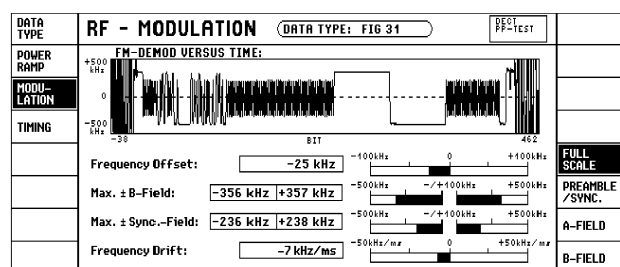

RF modulation measurement

## Overview of options

Designation, functions	Option	Order No.
<b>OCXO Reference Oscillator:</b> Improves aging and frequency drift of the internal reference source	R&S®CMD-B1	1051.6002.02
<b>Reference Frequency Input/Output, Frequency Synchronization:</b> Provides a 10 MHz interface as a common frequency reference	R&S®CMD-B3	1051.6202.02
<b>DSP/Adapter for R&amp;S®CMD-B4x options:</b> DSP system carrying out applications for GSM RF and audio tests as well as DECT audio tests. In contrast to GSM, this option is not required for DECT BER measurements	R&S®CMD-B4	1051.6654.02
<b>AF Measurement Unit with Frequency Counter (R&amp;S®CMD-B4 needed):</b> Provides an audio measurement unit with AF generator and AF analyzer. The parameters measured are level (peak and rms), frequency, and distortion on selectable frequencies. In addition, the option incorporates a 60-MHz TTL counter to verify the DUT's reference frequency	R&S®CMD-B41	1051.6902.02
<b>IEC/IEEE bus Interface:</b> in addition to the standard RS-232-C interface, the R&S®CMD can be fitted with this remote-control interface (R&S®CMD-B6 required)	R&S®CMD-B61	1051.7609.02
<b>Adapter for R&amp;S®CMD-B6x options</b>	R&S®CMD-B6	1051.7409.02
<b>Frequency Extension DECT CH +12 to -22</b> for Latin America and other countries	R&S®CMD-K61	1082.3840.02

## Specifications in brief

You will find detailed and binding data on the enclosed CD (./DATASHEET/CMD60.pdf), or, for the latest updates, visit [www.rohde-schwarz.com](http://www.rohde-schwarz.com), search term: **CMD60**

<b>DECT signal generator</b>	specifications valid for N connector
Frequency	10 DECT channels 0 to 9
Additional DECT channels	-3 to -1, 10 to 12 and half channels
Level range	-100 dBm to -40 dBm
Burst switch-off	>30 dB
Modulation	GFSK (B × T = 0.5)
<b>DECT analyzer</b>	specifications valid for N connector
Frequency	same as signal generator
Level (setting for external attenuation and expected power shall be matching: -10 dBm to +30 dBm)	-65 dBm to +30 dBm (for level meter) -30 dBm to +30 dBm (for broadband FM demodulator and signalling), values shifted by about -40 dB for input 2
<b>FM demodulator</b>	for TX postprocessing and analog output
Range	0 Hz to 450 kHz deviation
Resolution	1 kHz
Level meter (transient response)	for TX postprocessing and analog output
Range	-65 dBm to 30 dBm
Dynamic	70 dB
<b>Analog DECT ADPCM interface</b>	
Output	balanced
Range	1 V, 300 Hz to 3 kHz
S/N + THD	50 dB at full-range level
Input	balanced
Range	50 mV, 300 Hz to 3 kHz
S/N + THD	50 dB at full-range level
<b>DC measurements</b>	
DC voltmeter	0 V to ±30 V
DC ammeter	0 A to ±10 A

## Option R&S®CMD-B4 with R&S®CMD-B41

<b>AF meter</b>	
Frequency range	50 Hz to 10 kHz
Input voltage	0.1 mV to 30 V
<b>AF distortion meter</b>	
Frequency range	300 Hz to 3 kHz
Input voltage	100 mV to 30 V
<b>AF counter</b>	
Frequency range	20 Hz to 10 kHz
Input voltage	10 mV to 30 V
Resolution	1 Hz
<b>60 MHz counter</b>	
Frequency range	10 kHz to 60 MHz
Input signal	min.: 100 mV; max.: TTL signal
Resolution	1 Hz
<b>AF generator</b>	
Frequency range	50 Hz to 10 kHz
Output voltage	10 μV to 5 V

## General data

Power supply, AC	100 V to 120 V ±10%, 200 V to 240 V ±10%, 50 Hz to 400 Hz ±5%
Power consumption	approx. 60 VA
Dimensions (W × H × D)	435 mm × 192 mm × 363 mm
Weight (without options)	approx. 12 kg

## Ordering information

<b>Digital Radiocommunication Tester</b>	R&S®CMD60	1050.9008.60
<b>Options</b>	see overview of options	



Contents Overview

Chapter Overview

Type Index

R&S Addresses



## DECT Signalling Test Unit R&S®PTW 15

### Support in installation and maintenance of DECT networks



### Brief description

The powerful DECT Protocol Tester R&S®TS 1220 is seconded by the extremely favourably priced DECT Signalling Test Unit R&S®PTW 15. This unit can be used wherever the full functionality of R&S®TS 1220 is not required: in installation and maintenance of DECT WLL and PABX systems, in DECT audio tests according to CTR 10 and in the field of DECT software development.

In the installation of DECT WLL networks or test networks, R&S®PTW 15 produces data about the occupancy of the DECT frequency band including relevant statistics to support antenna positioning and assessment of various parameters of the DECT equipment (e.g. dynamic channel selection algorithm). Since most tests are carried out on site directly in the network, the unit was designed for mobile use through its compact size and optional battery powering. For DECT audio tests to CTR 10, R&S®PTW 15 can be used as a DECT signalling unit that supports call setup to portable and fixed DECT radio terminations both in normal operation (generic access profile GAP according to

EN 300 444) and in test standby mode by providing voice data at an analog and a digital interface. The required DECT reference implementations can also be used for DECT software development.

The DECT Signalling Test Unit comes with channel-occupancy software covering all DECT activities at the air interface as well as with a monitor mode for recording and analyzing selected DECT activities between user-defined fixed radio terminations (FT) and the associated portable radio terminations (PT).

The implemented DECT protocol stack is mapped on the hardware as follows: the time-critical physical layer (PHL) and medium access control layer (MAC) are implemented in the DECT-specific module. The data received between PHL and MAC at the point of observation are imaged in the processor kernel and displayed. The data link control layer and network layer, used for reference implementations, run as independent processes in the processor kernel.

All layers communicate via points of control and observation (PO/PCO).

### Main features

#### Main applications

- ◆ DECT coverage measurement (installation and test)
- ◆ DECT network control (maintenance and optimization of WLL networks and PABX systems)
- ◆ DECT software and hardware development
- ◆ Signalling unit for DECT audio tests according to CTR 10
- ◆ Designed for mobile and stationary operation

#### Main functions

- ◆ Channel occupancy measurement: scanning and visualization of the air interface in the DECT frequency ranges Europe, China, South and Latin America; analysis of the scanned data by scanner postprocessing
- ◆ Built-in PT and FT reference implementation according to EN 300 444 (Generic Access Profile)

Protocol monitoring and analysis between the DECT layers according to EN 300 444.



Contents Overview

Chapter Overview

Type Index

R&S Addresses





## Specifications in brief

You will find detailed and binding data on the enclosed CD (../DATASHEET/PTW15.pdf), or, for the latest updates, visit [www.rohde-schwarz.com](http://www.rohde-schwarz.com), search term: PTW15

### Basic instrument

CPU	AMD K5 (586), 133 MHz
Display	8,4" TFT colour display, VGA
Graphics for external monitors	max. 1024 × 768 pixels
Storage	Hard disk, FDD 3½"
Interfaces	4 × ISA
Serial	2 × RS-232-C
Parallel	1 × LPT (Centronix) for printer
Keyboard	DIN and PS/2
Operating system	LynxOS
User interface	MGR
Operating temperature range	0°C to + 40°C
Power supply	100 V to 120 V ±10%, 50 Hz to 400 Hz ±5%, and 220 V to 240 V ±10%, 50 Hz to 60 Hz ±5%
Power consumption	max. 120 W
DC	10 V to 32 V
Dimensions (W × H × D)	412 mm × 198 mm × 380 mm
Weight	8 kg

### RF Parameters

<b>Operating frequency Europe</b>	1881.792 MHz to 1897.344 MHz
<b>Optional (exclusive options)</b>	
China	1902.528 MHz to 1918.080 MHz
South America	1911.168 MHz to 1926.720 MHz
Latin America	1912.896 MHz to 1928.448 MHz
Carrier spacing	1.728 MHz
Carrier multiplex	TDMA
Duplexing	TDD
Bit rate	1152 kbps
Modulation method	GFSK (B × T = 0.5)
<b>TX specifications</b>	
Normal transmitter power	21 dBm ± 2 dBm
Nominal peak deviation (modulation)	288 kHz (acc. to CTR06)
Carrier frequency (acc. to CTR06)	DECT carrier frequency ± 30 kHz
Synthesizer	transmitter burst acc. to CTR06 (slow synthesizer => 'blind slots'); hardware signalling (R&S®PTW15 DECT Sig. Board)
<b>RX Specifications</b>	
Sensitivity (acc. to CTR06)	-73 dBm for BER <0.00001
RSSI	-33 dBm to -93 dBm
Maximum level (without damage)	25 dBm
Maximum level (for measurements)	0 dBm

### Channel occupancy measurement

<b>RSSI (permanent)</b>	
Resolution time	<14 ms
Resolution level	1 dB
Range	0 dBm to -93 dBm
Data indication	graphically online, update rate 1/s
Scanning rate	min. 3 RSSI scanning loops covering all DECT channels per second.

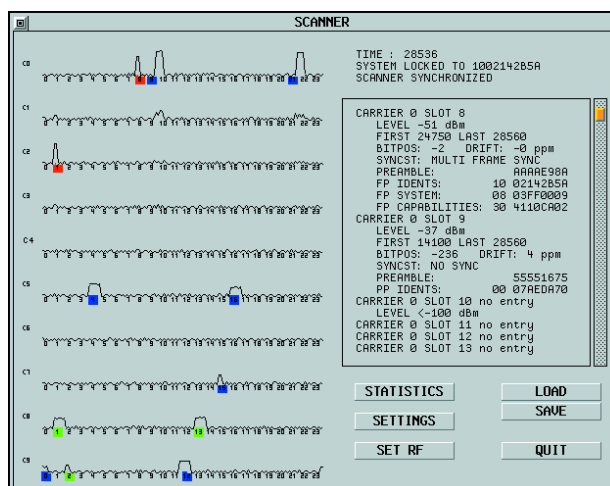

For channel monitoring purposes the activities on all DECT channels/slots are indicated numerically and graphically including information on fieldstrength, identities, drift, offset etc; the information is automatically stored in a database

### Database

Continuous recording of data packages  
 Classification: locked, coordinated, uncoordinated, not classified  
 Permanent scan, simultaneous for fixed (FT) and portable radio termination (PT)  
 Contents of database record: time of recordings, number of recordings, preamble, level, bit position, drift, identities, system parameters, etc  
 Assignment of database records to the graphical RSSI indication under consideration of system identities, coordinated and uncoordinated fixed radio terminations

### Statistics

Channel occupancy statistics  
 Graphical indication (coloured)  
 Statistics referring to EN 300 175 Common Interface 'Channel selection algorithm'

### GPS data

NMEA 0183 Interface Standard can be connected to the serial interface; GPS data will be displayed and included in the database file

## Ordering information

<b>DECT Signalling Test Unit</b>		
Light	R&S®PTW 15L	1074.6009.04
China	R&S®PTW 15CN	1074.6009.03
South and Latin America <sup>1)</sup>	R&S®PTW 15LA	1074.6009.05
<b>Options</b>		
Comfort package (ext. keyboard + adapter)	R&S®PTW-B1	1074.6509.02
Battery module for mobile operation	R&S®PSP-B3	1091.3740.02
Frequency range China (replaces module Europe)	R&S®PTW-B3	1115.2501.02
Frequency range South and Latin America (replaces module Europe)	R&S®PTW-B4	1115.2701.02

<sup>1)</sup> Frequency channel difference between adjustable in the software.

## Wireless Protocol Tester R&S®PTW70

- IEEE 802.11 multimode protocol tester for development, integration and verification
- Bluetooth® wireless technology protocol tester for qualification and verification

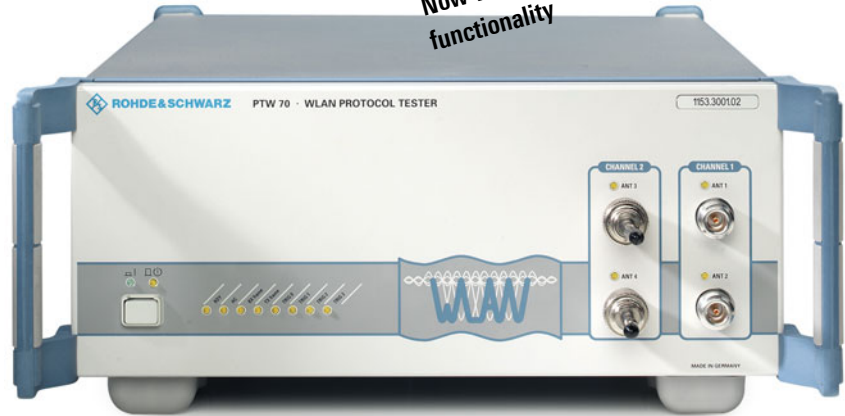

WLAN Protocol Tester R&S®PTW70

### Brief description (WLAN)

The WLAN Protocol Tester R&S®PTW70 is an indispensable error diagnostics tool for wireless LAN system components from chip set to complete infrastructure. By accommodating wireless LAN software and hardware modules, the R&S®PTW70 can be used to evaluate how different system components interact and to test cross-technology compatibility. Due to its special design, the R&S®PTW70 allows the performance and quality features of wireless LAN system components to be objectively evaluated for the first time.

The WLAN Protocol Tester R&S®PTW70 represents a considerable enhancement in speed, accuracy and cost-effectiveness in the complex measurement tasks involved in multi-standard wireless LAN systems.

Since it supports controlled error simulation in the protocol sequence, manipulation of test sequences, realtime analysis and complete documentation of results, the WLAN Protocol Tester R&S®PTW70 is an indispensable tool in the development, integration and verification of wireless LAN systems.

R&S® PTW70	Bluetooth wireless technology	Wireless LAN
Specification/Standard	1.1 & 1.2	IEEE802.11a/b/g
Applications	Conformance and verification tests	Development, integration and verification tests
Test Suites	BB, LM, L2CAP, GAP, SDP & SPP	Customized (e.g. to pass tests at Wi-Fi Alliance)
GUI / Control	Highly optimized to meet the requirements of the Bluetooth SIG's qualification process	Online tools, monitor mode and analyzer mode, multi-choice operating concept
Operating System/GUI	Windows2000/XP	

*The Protocol Tester R&S®PTW70 is available for the standards Bluetooth® 1.1 and 1.2 as well as for WLAN IEEE802.11a/b/g. Both functions may be ordered separately or combined in one single unit*

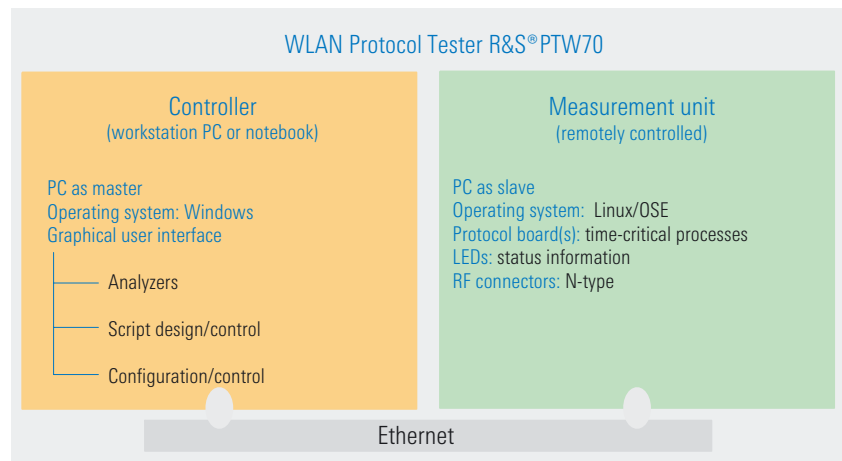

Design of the WLAN Protocol Tester R&S®PTW70



## Wireless Protocol Tester R&S®PTW70

### Main features (WLAN)

- ◆ Analyzer mode – The IEEE 802.11 reference model of the R&S®PTW70 simulates a wireless LAN access point or a station
- ◆ Sniffer or monitor mode – the R&S®PTW70 records data communications in a wireless LAN cell
- ◆ The multi-choice operating concept features graphical and programmable user interfaces
- ◆ Online analysis tools provide the user with reliable data exactly when needed
- ◆ Hardware-based timers and realtime processing make it possible to analyze protocol sequences in detail in all operating modes
- ◆ The measurement unit is detached from the controller and can be remotely driven from different workstations
- ◆ The modular design allows flexible tester configurations specific to a given measurement task – from the single-channel model to versions networking several R&S®PTW70 testers
- ◆ Its predefined set of applications is tailored to specific user groups
- ◆ Its powerful hardware platform makes the tester a future-proof investment

### Characteristics (WLAN)

#### What does IEEE 802.11 multimode protocol tester mean?

IEEE 802.11 currently specifies wireless LAN systems for the 2.4 GHz ISM frequency band (802.11b and 802.11g) and the 5 GHz U-NII frequency band (802.11a). The R&S®PTW70 supports the 802.11a and 802.11g systems, i.e. it offers a wide range of functions from the RF frontend, the physical protocol layer, the MAC protocol layer through to applica-

tions. As to 802.11b functionality, the focus is on interoperability measurements, particularly the monitor mode and analysis functions for testing 802.11b and 802.11g interoperability.

#### Modular design

The WLAN Protocol Tester R&S®PTW70 consists of a measurement unit and a controller (workstation PC or notebook). The two components are connected via Ethernet directly or as part of a network. The detached measurement unit of the R&S®PTW70 can be configured and monitored via a graphical user interface. The measurement data is returned to the controller and can be evaluated conveniently using graphical analysis tools.

#### Measurement unit

Using a standard PC architecture, the R&S®PTW70 measurement unit can simultaneously carry out measurements, record measured data and, in the background, send the data to the detached controller. The baseband architecture is oriented to the realtime requirements of the PHY layer and the MAC layer. The baseband board is designed to support future requirements of the WLAN standards by installing software updates.

#### Software concept

The R&S®PTW70 uses three operating systems. All time-critical processes run on the OSE realtime operating system and are executed by accessing a reliable Rohde&Schwarz protocol stack model. The PC of the measurement unit runs on the Linux operating system, which is also used to communicate with the controller. The user interface is designed for 32-bit Windows operating systems. Three tools are available to enable optimal configuration of the R&S®PTW70 for a given measurement task.

- ◆ Graphical script editor: the direct way to measurement results
- ◆ Script-based programming interface: time-saving in automatic tests
- ◆ C++ library: error simulation for quality assurance at all stages of development

### Brief description (Bluetooth®)

Rohde & Schwarz has been involved in *Bluetooth®* Wireless Testing since the very beginning of Bluetooth® itself. The Protocol Tester PTW60 for Bluetooth® 1.1 is the most widely used protocol tester for Bluetooth® qualification testing.

The Bluetooth® option for the R&S®PTW70 allows automatic performance of conformance test cases for Bluetooth® protocols and profiles, according to the Bluetooth® qualification test case reference (TCRL), both for 1.1 and 1.2 implementation.

### Main features (Bluetooth®)

- ◆ Based on the official 1.1 and 1.2 TTCN test cases for BB, LM, L2CAP, GAP, SDP and SPP/RFCOMM
- ◆ R&S®PC based platform
- ◆ Friendly graphic user interface (GUI)
- ◆ Manual/automatic test cases selection
- ◆ ICS/IXIT edition
- ◆ Test case mapping, according to official TCRL
- ◆ Static conformance review
- ◆ Verdict handling
- ◆ Test log analysis
- ◆ Decoding, filtering and debugging
- ◆ EUT(equipment under test) database
- ◆ Automatic test report generator



## Wireless Protocol Tester R&S®PTW70

### Characteristics (Bluetooth®)

- ◆ The R&S®PTW70 basic unit consists of a Rohde&Schwarz industrial PC board that is commonly used in all recent Rohde&Schwarz measurement instruments. Running on Windows2000, it hosts the control and test software
- ◆ The hardware option for Bluetooth® consists of all necessary components for RF modulation, demodulation and the lower layers functionality. It is implemented as a PCI card fitted into the R&S®PTW70 basic unit
- ◆ The R&S®PTW70 Bluetooth® option uses the ISO standard as a basis for the methodology of conformance testing (ISO/IEC 9646, parts 1 to 7)
- ◆ The implemented test cases are based on the Bluetooth® abstract test suites written in TTCN

In order to comply with the Bluetooth® abstract test suites, the R&S®PTW70 Bluetooth® option contains the following interfaces:

- ◆ LC-PL
- ◆ LM-LC
- ◆ L2CAP-SAR
- ◆ LM-A
- ◆ LM-B
- ◆ LM-C
- ◆ RFCOMM-L2CAP
- ◆ SDP-L2CAP
- ◆ TCI-HCI

The following test suites are covered:

- ◆ Base band test cases
- ◆ Link manager test cases
- ◆ Logical link control and adaptation protocol test cases
- ◆ Service discovery protocol test cases
- ◆ Generic access profile test cases
- ◆ Serial port profile and RFCOMM test cases

### Measurement capabilities

The graphical user interface of the R&S®PTW70 Bluetooth® Option is easy to use, but powerful and flexible at the same time.

The user will create a test project where all the information related to the manufacturer or IUT hardware/software version will be stored. A database will allow easy registration and recovery of already performed campaigns. Then, the ICS/IXIT information has to be filled and it will provide all the data necessary for the Test Case selection and information for the execution. The test operator can fill this data in a normal Microsoft Office Excel Sheet (using a template which is provided), and the system will import this data automatically. Another possibility is to fill and edit the ICS/IXIT directly in the Graphical User Interface.

The ICS information is checked automatically for the tester (Static Conformance Review), and in case of errors, the system will indicate the problem. When all the ICS are correct, the software will produce the Test Case Mapping Table containing all the applicable Test Cases. Those Test Cases can be executed individually or in batch.

The results of the execution, information through PCOs (Points of Control and Observation), timers, preliminary verdicts, etc, can be analysed.

### Filtering capabilities

- ◆ Start Test Case: shows/hides the test case identifier and the start execution time
- ◆ Test Case Ended: shows/hides the test case identifier and the end execution time

- ◆ Start PTC: shows/hides the test step identifier and the start execution time
- ◆ PTC Ended: shows/hides the test step identifier and the end execution time
- ◆ Assignment: shows/hides the assignments to TTCN variables (PDUs, etc.)
- ◆ Send Event: shows/hides the events sent via coordination points to a parallel test component
- ◆ Receive Event: shows/hides the events received via coordination points from a parallel test component
- ◆ Otherwise Event: shows/hides the information of an event which followed the "otherwise" condition in the test case
- ◆ Start Timer: shows/hides the start of a timer
- ◆ Cancel Timer: shows/hides the cancellation of a timer
- ◆ Stop Timer: shows/hides the stop of a timer
- ◆ Time Out: shows/hides the expiry of a timer
- ◆ Preliminary Verdict: shows/hides preliminary verdicts
- ◆ Final Verdict: shows/hides the final verdict of the test case

Finally, with the automatic report generator, the test case results and information relative to the manufacturer and IUT will be included in a Microsoft Office Word document automatically. The test report format follows the recommendations given in the standard ISO 9646 (including Static Conformance Test Reports, PICS, PIXIT and test logs), although customer can customize some aspects of the report template.

## Wireless Protocol Tester R&S®PTW70

### Specifications in brief

You will find detailed and binding data on the enclosed CD (./DATASHEET/PTW70.pdf), or, for the latest updates, visit [www.rohde-schwarz.com](http://www.rohde-schwarz.com), search term: PTW70

Data for *Bluetooth*® model on request

#### TX/RX

Frequency range	
– Band 1 IEEE802.11b	2400 MHz to 2500 MHz
– Band Japan IEEE802.11a	4910 MHz to 5080 MHz
– Band 2 IEEE802.11a	5150 MHz to 5350 MHz
– Band 3 EU HiperLAN2	5470 MHz to 5725 MHz
– Band 3 US IEEE802.11a	5725 MHz to 5825 MHz
RF frequency response (band 1)	1 dB

#### TX

Modulation	
EVM ( $P_{out} = 0$ dBm)	>28 dBm
Spurious (10 kHz to 200 MHz offset)	–40 dBc
Harmonics (2nd and 3rd order)	–30 dBc
Output level	
Max.	+6 dBm
Range	20 dB

#### RX

Immunity to interference	
Image rejection	>30 dB
IF rejection	>30 dB
IF1: 1150 MHz	>30 dB
IF2: 20 MHz	>50 dB
Sensitivity (packet error rate PER: 10%, according to S/N)	–82 dBm at 6 Mbit/s (~S/N = 12 dB) –65 dBm at 54 Mbit/s (~S/N = 29 dB)
Max. input level	–30 dBm

#### Interfaces

LAN, USB, VGA
---------------

#### General data

Operating temperature range	+5°C to +45°C
Power supply	100 V to 240 V AC, max. 310 VA, 50 Hz to 60 Hz
Dimensions (W × H × D)	310 mm × 140 mm × 430 mm
Weight	10 kg

### Ordering information

<b>Basic Unit</b>	R&S®PTW70	1153.3001.02
Case, PC architecture, boot manager		
<b>Options</b>		
WLAN Hardware: Protocol board, RF module (interim version), operating system, cabling, CD, dongle, user manual	R&S®PTW70-WLA (interim)	1501.2108.02
WLAN Hardware: Protocol board, RF module (final version), operating system, cabling, CD, dongle, user manual	R&S®PTW70-WLA	1501.2108.03
WLAN Software – Sniffer: Operational software for 802.11b/g/a, passive mode = sniffer/monitor; option file	R&S®PTW70-Sn 802.11 B/G/A PA	1501.2408.02
WLAN Software – Reference for 802.11b/g and Sniffer: Operational software for 802.11b/g, active mode = reference simulating STA or AP; passive mode = sniffer/monitor; option file	R&S®PTW70-BG 802.11 B/G PA/AC	1501.2350.02
WLAN Software – Reference for 802.11b/g/a and Sniffer: Operational software for 802.11b/g/a, active mode = reference simulating STA or AP; passive mode = sniffer/monitor; option file	R&S®PTW70-ABG 802.11 B/G/A PA/AC	1501.2308.02
WLAN Software – Programming Interface: C++ Library and SAP control interface; Option file; Programming manual	R&S®PTW70-SAP C++ SAP Interface	1501.2250.02
<b>Software service and maintenance for 1 year including GLORIS problem report database and software download account</b>		
Sniffer	R&S®PTW70-Sn Service	
MANDATORY FROM THE BEGINNING		
B/G Reference/Sniffer	R&S®PTW70-BG Service	
B/G/A Reference/Sniffer	R&S®PTW70-ABG Service	
SAP C++ Programming Interface	R&S®PTW70-SAP Service	
<b>Hardware/software upgrades for Bluetooth®</b>		
Bluetooth HW/SW Upgrade (Core Specification 1.1 & 1.2)	R&S®PTW70-BTU	1501.1801.02
For customers owning a R&S®PTW60 Bluetooth Protocol Tester only!	R&S®PTW70-BT	1501.1801.03
Bluetooth HW/SW (Core Specification 1.1 & 1.2)		

## Radiocommunication Service Monitors R&S® CMS 50/54

### 0.4 MHz to 1000 MHz

Radio testers for service, production and development

*Radiocommunication Service Monitor R&S® CMS 54*

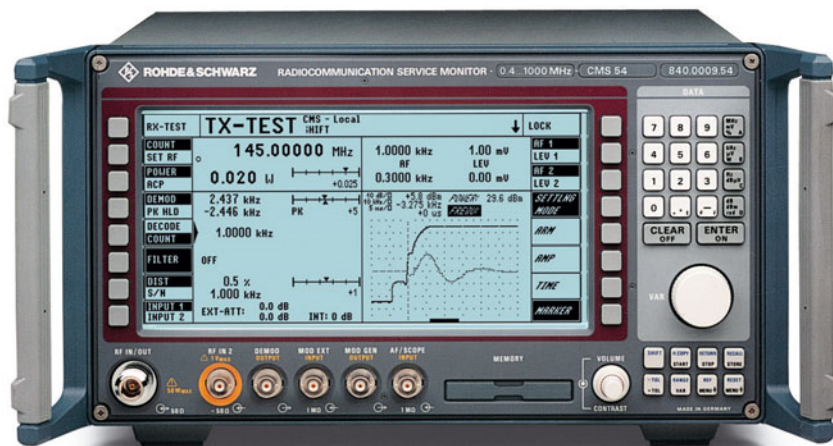

### Brief description

The Radiocommunication Service Monitors R&S® CMS can alone perform transmitter and receiver testing, measurements on antennas, diplexers, filters and frequency-converting modules as well as modulation spectrum analysis. The signalling unit supports all important mobile radio standards. With its full-feature configuration offering enhanced measurement capabilities, this light-weight and compact tester, which is suitable for mobile and stationary use alike, satisfies all requirements of radio measurements.

### Main features

- ◆ AM, FM or  $\phi$ M and SSB
- ◆ Analog and digital signalling
- ◆ Large, high-contrast LCD
- ◆ Operation via softkeys
- ◆ Clear menu structure
- ◆ Simultaneous and easy-to-read display of settings and results
- ◆ Manual and automatic measurements
- ◆ Tracking generator
- ◆ Cable fault test
- ◆ Spectrum monitor
- ◆ Stationary and mobile use
- ◆ Low weight, compact size

### Overview of models

#### R&S® CMS50 – the budget-priced model for service applications

- ◆ Transmitter and receiver testing
- ◆ Spectrum monitor
- ◆ Fully automatic testing
- ◆ SSB test
- ◆ ERMES coder

#### R&S® CMS54 – the high-end tester for demanding requirements in production and development

- ◆ Radio measurements same as R&S® CMS50
- ◆ Basic model additionally with:
  - ◆ Full-span tracking generator from 0.4 MHz to 1000 MHz
  - ◆ Adjacent-channel power meter with standard ETSI filters
  - ◆ Duplex modulation meter
  - ◆ Automatic harmonic measurement
  - ◆ Cable fault test

### Operation

- ◆ All functions are clearly displayed; 16 softkeys allow direct access to individual parameters
- ◆ The large, backlit LCD screen provides clear and simultaneous readout of all test results, entries and functions

- ◆ Hardcopy of screen display, entry of tolerance and reference values are made at a keystroke
- ◆ Settings can be varied in selectable steps using the spinwheel
- ◆ Programs, instrument settings and test results can be stored on memory cards
- ◆ Additional inputs and outputs allow independent and versatile use of signal sources and test facilities

### Automatic tests

Automatic test routines are indispensable for high throughput and reproducible results in service and production: in the learn mode, the Radiocommunication Service Monitor R&S® CMS stores all manual settings and measurements and produces from them ready-to-start automatic test routines. The user need not have any programming knowledge or learn equipment-specific command sets. Tolerances, comments and conditions (loops, jumps, queries and control commands) can additionally be inserted into the test routines. Programs can also be activated directly from the memory card. The test report format may be user-specified and can be clearly structured by transferring control characters to the printer, such as blank line, paragraph and bold-face.

## Radiocommunication Service Monitors R&S® CMS 50/54

### R&S® CMS – a test set replacing many individual measuring instruments

Due to the comprehensive standard configuration of the individual models and the optional extensions tailored to specific applications, external measuring instruments in addition to the R&S® CMS are not required.

#### Signal sources

- ◆ RF synthesizer with AM, FM, φM and multitone modulation capabilities
- ◆ Two independent modulation generators
- ◆ Selective-call encoder to all standards (also user-programmable)
- ◆ CDCSS coder
- ◆ DTMF coder
- ◆ Reference frequency input/output

#### Signalling

- ◆ NMT 450/900, E-AMPS, R2000
- ◆ E-TACS, J-TACS, TACS Issue 4
- ◆ POCSAG, ZVEI digital, VDEW digital
- ◆ ERMES pager test

#### Measuring facilities

- ◆ RF frequency counter, RF frequency-offset counter
- ◆ Power meter
- ◆ Selective RF power meter
- ◆ RF spectrum monitor with wide dynamic range and filters which also allow modulation analysis (AM, FM, SSB)
- ◆ Tracking generator
- ◆ Adjacent-channel power meter with standard ETSI filters
- ◆ Modulation meter for AM, FM and φM; weighting: +PK, -PK, PK HOLD, ±PK/2, RMS, RMS √2
- ◆ Duplex modulation meter for duplex spacings of any size

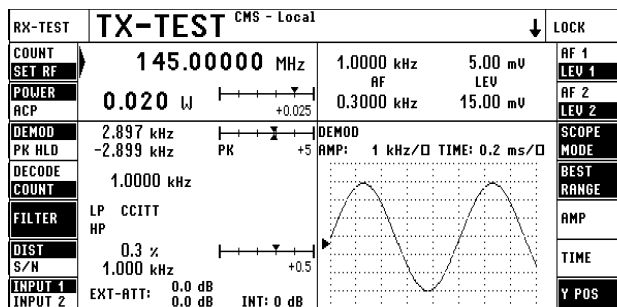

*RF measurements, evaluation of demodulated signals and setting of modulation generators*

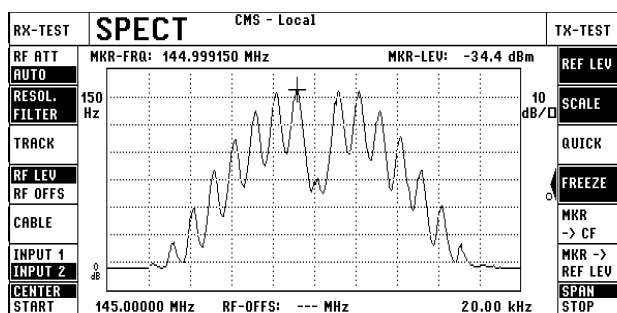

*150 Hz filter allowing direct modulation analysis for AM, FM and SSB*

- ◆ AF voltmeter with peak and true RMS weighting
- ◆ SINAD meter with variable test frequency
- ◆ S/N/distortion meter with variable test frequency
- ◆ AF frequency counter with period and gate-time counting
- ◆ Selective-call decoder for all standards (also user-programmable)
- ◆ DTMF decoder
- ◆ Oscilloscope
- ◆ DC ammeter/voltmeter
- ◆ Transient recorder for analysis of power and frequency transients
- ◆ Cable fault test

- ◆ Highpass and lowpass filters for band limiting and measurement of subaudio tones

#### Other facilities

- ◆ Second RF input with high sensitivity for off-air measurements, can be used independently for module testing
- ◆ Built-in 600 Ω AF transformers for modulation generator and AF voltmeter
- ◆ Connector for battery (11 V to 32 V)
- ◆ 13 dBm RF output for off-air measurements
- ◆ Memory for storing complete instrument setups

#### Filters

- ◆ ITU-T or C-message filters for weighting to relevant standards
- ◆ Continuously tunable bandpass filter with high skirt selectivity for selective modulation and AF measurement
- ◆ Continuously tunable notch filter for signal suppression

## Radiocommunication Service Monitors R&S®CMS50/54

Extensions for basic model	Option	R&S® CMS50	R&S® CMS54	Order No.	Specifications
OCXO Reference Oscillator For long-term stability	R&S®CMS-B1	○	○	0840.9406.02	See timebase Aging $2 \times 10^{-7}/\text{year}$
<b>OCXO Reference Oscillator</b> For extremely high long-term stability	R&S®CMS-B2	○	○	1001.6809.02	Specs same as R&S®CMS-B1, except for aging $\leq 1 \times 10^{-7}/\text{year}$
<b>Duplex Modulation Meter</b> For operation of RF frequency counter and modulation meter independent of RF generator (two-port measurements, also on frequency-converting modules)	R&S®CMS-B59	○	—	1032.0990.02	Specs same as basic model, except residual FM $\leq 10$ Hz
<b>Duplex Modulation Meter</b> Same as R&S®CMS-B59, plus adjacent-channel power meter for measurements on duplex radio, cellular mobile phones and frequency-converting modules	R&S®CMS-B9	—	●	0840.9506.02	Specs same as basic model, adjacent-channel power meter with ETSI filters Channel spacings Dynamic range $10/12.5/20/25$ kHz and user-selectable up to 1 MHz $\geq 70$ dB (channel spacing 25 kHz)
<b>10 MHz Reference Frequency Input/Output</b> External synchronization for measuring systems	R&S®CMS-B22	○	○	1001.6750.02	Output Input TTL signal, $Z_{\text{out}} \approx 50 \Omega$ , $f = 10$ MHz level $> 1.5$ V ( $V_{\text{pp}}$ ), $Z_{\text{in}} \approx 50 \Omega$ , $f = 10$ MHz $\pm 500$ Hz
<b>100 W RF Power Meter</b> Measurement of high RF input power	R&S®CMS-B32	○	○	1001.7905.02	Maximum input power: 100 W for 3 min, then 10 min power off; continuous power: 80 W; max. output level and measurement sensitivity at input 1 reduced by 3 dB; additional error: $\leq 0.15$ dB ( $P > 40$ mW, AM=0%)
<b>13 dBm Output</b>	R&S®CMS-B34	○	○	1032.1350.02	Additional power output for off-air measurements
<b>IEC/IEEE bus Interface</b>	R&S®CMS-B54	○	●	1032.0748.02	Use of R&S®CMS50 in automatic test systems
<b>Signalling units for models with Duplex Modulation Meter R&amp;S®CMS-B9 or R&amp;S®CMS-B59</b>					
<b>Signalling Unit for Cellular Radio</b> NMT 450/900, E-AMPS, E-TACS, J-TACS, TACS Issue 4 (opt.), R 2000	R&S®CMS-B53 <sup>1)</sup>	○	○	1032.0890.02	Simulation of base station for testing cellular mobile phones, e.g. call setup, call clear-down, channel and power change
<b>Signalling for POCSAG, ZVEI/VDEW digital for R&amp;S®CMS-B53</b>	R&S®CMS-B26	○	○	1031.9993.10	

<sup>1)</sup> R&S®CMS-B59 also required.

- fitted as standard
- option
- not possible



## Radiocommunication Service Monitors R&S®CMS50/54

Optional control interfaces <sup>1)</sup>					
Order No.	R&S® CMS-B5 0841.0502.10	R&S® CMS-B55 1032.0790.02	R&S® CMS-B20 0841.1209.02	R&S® CMS-B39 1032.0090.02	Specifications
<b>DTMF Decoder</b>	●	●	●	●	Decoding of DTMF dual tones and VDEW direct dialling
<b>CCITT Filter</b>	●	●	●	●	
<b>Centronics Interface</b>	●	●	●	●	
<b>Relays</b>	8	–	–	4	With max. 1 W switching power, $V_{max}=30\text{ V}$ , $I_{max}=0.1\text{ A}$
<b>TTL Input/Output</b>	12	–	–	8	Outputs: 25 mA
<b>DC Ammeter/Voltmeter, floating</b>	–	–	●	–	Voltage measurement Range Resolution Error Current measurement Range Resolution Error
<b>600 Ω AF Transformers</b>	–	–	–	●	Output impedance of AF generator Frequency range Output voltage Max. output current Input impedance of AF voltmeter Frequency range
<b>VSWR Measurements</b>	R&S®CMS-Z37 <sup>2)</sup>	–	–	R&S®CMS-Z37 <sup>2)</sup>	Connection of Insertion Units R&S®NAS-Z1, -Z3, -Z5, -Z6 (GSM900), -Z7 (GSM 1800) with direct reading of VSWR as well as forward and reflected power

<sup>1)</sup> Choice of one option.

<sup>2)</sup> R&S®CMS-B5 or -B39 required for Insertion Units R&S®NAS-Z1/-Z3/-Z5/-Z6/-Z7.

- fitted as standard
- not possible

## Radiocommunication Service Monitors R&S®CMS50/54

### Specifications in brief (all R&S®CMS models)

You will find detailed and binding data on the enclosed CD (./DATASHEET/CMS.pdf), or, for the latest updates, visit [www.rohde-schwarz.com](http://www.rohde-schwarz.com), search term: CMS

**Bold-faced** values in brackets refer only to R&S®CMS54.

#### Receiver measurements

<b>Signal generator</b>	
Frequency range	0.4 MHz to 1000 MHz <b>(usable from 100 kHz)</b>
Frequency resolution	50 Hz <b>(10 Hz)</b>
Level	
FM, φM, CW	-134 dBm to 0 dBm
AM	-134 dBm to -3 dBm
Level resolution	0.1 dB
Accuracy	±2 dB
Harmonics	≤-20 dBc (≤-25 dBc)
Nonharmonics	≤-50 dBc
Phase noise	≤-110 dBc (20 kHz from carrier, referred to 1 Hz test bandwidth)
<b>Modulation</b>	
Frequency range	2 MHz to 500 MHz <b>(0.4 MHz to 1000 MHz)</b>
AM depth	0% to 99%
Mod. frequency range	DC to 20 kHz
FM deviation	0 hZ to 100 kHz (50 Hz to 50 kHz)
Resolution	1 Hz
Mod. frequency range	20 Hz to 20 kHz
Mod. distortion	≤1%
φM deviation (internal)/resolution	0 rad to 10 rad/1 mrad
Mod. frequency range	100 Hz to 6 kHz
Mod. distortion	≤1%
<b>AF voltmeter</b>	
Frequency range	50 Hz to 20 kHz
Measurement range/resolution	0.1 mV to 30 V/100 μV
Input impedance	approx. 1 MΩ

#### Transmitter measurements

<b>RF power meter</b>	
Frequency range	1.5 MHz to 1000 MHz (2 MHz to 1000 MHz)
Measurement range	5 mW to 50 W (100 W optional)
Accuracy (P > 20 mW, AM=0%)	0.4 dB + resolution
Selective level measurement	in frequency range 1 MHz to 1000 MHz
Level range	-60 to +47 dBm w/o weighting filter, -80 dBm to +47 dBm with 2 kHz resonance filter
<b>RF frequency counter</b>	
Frequency range	0.5 MHz to 1000 MHz (usable from 100 kHz, IF narrow)
Input level range (CW, FM)	
Input 1	0 dBm to +47 dBm
Input 2	-40 dBm to +7 dBm

<b>Frequency deviation meter</b>	
Operating modes	+PK, -PK, ±PK/2, PK HOLD, RMS, RMS√2
Measurement range	0 Hz to 50 kHz <b>(0 Hz to 100 kHz)</b>
AF frequency range	20 Hz to 15 kHz <b>(20 Hz to 20 kHz)</b> (DC-coupled at demodulator output)
Resolution	1 Hz
<b>Phase deviation meter</b>	
Operating modes	+PK, -PK, ±PK/2, RMS, RMS√2
Measurement range/resolution	0.001 rad to 5 rad/0.001 rad
AF frequency range	300 Hz to 6 kHz
<b>AM depth meter</b>	
Operating modes	+PK, -PK, ±PK/2, RMS, RMS√2
Measurement range/resolution	0.01% to 99%/0.01%
AF frequency range	50 Hz to 10 kHz <b>(50 Hz to 20 kHz)</b>
RF spectrum monitor	1 MHz to 1000 MHz
Display dynamic range	>60 dB
Span	0 (zero span) to 50 MHz
Filter (3 dB bandwidth)	150 Hz, 6/16/50/300 kHz, 1/3 MHz (coupled to span)
<b>RF spectrum monitor (R&amp;S®CMS50)</b>	
Frequency range	1 to 1000 MHz, usable from 100 kHz
Span	0 Hz (zero span) to 50 MHz
Reference level	+47 dBm to -47 dBm (input 1)
Display dynamic range	>60 dB (for reference level >-7 dBm at input 1)
Resolution filter (3 dB bandwidth)	150 Hz, 6/16/50/300 kHz/1/3 MHz (coupled to span)
Resolution	0.4 dB
<b>RF spectrum monitor (R&amp;S®CMS54)</b>	
Frequency range	1 to 1000 MHz, usable from 100 kHz
Span	0 Hz (zero span) to 50 MHz; full span for frequency range 10 MHz to 1000 MHz
Reference level	+47 dBm to -47 dBm (input 1)
Sensitivity	<-110 dBm (for resolution filter 6 kHz and reference level ≤-37 dBm at input 2, f ≥10 MHz)
Inherent spurious response	<-50 dBc (for reference level >10 dBm and f >50 MHz)
Display dynamic range	>65 dB (for reference level >-7 dBm at input 1)
Scaling	2/5/10 dB/div
Display range	≤80 dB
Resolution filter (3 dB bandwidth)	150 Hz (for modulation analysis), 6/16/50/300 kHz/1/3 MHz (for full span), coupled to span
Error	<3 dB + resolution
Resolution	0.4 dB
<b>Transient recorder (R&amp;S®CMS54)</b>	
Measurement of power and frequency as a function of time with graphical display and selectable zoom	
Time scale	50 μs/div to 1 s/div, maximum recording time 40 s
Frequency transients	
RF frequency range	1 MHz to 1000 MHz
Measurement range (FM dev.)	0 to ±100 kHz
Scaling	0.5 kHz to 50 kHz/div
Triggering	internal, automatic (frequency changes >8 kHz)

## Radiocommunication Service Monitors R&S® CMS 50/54

<b>Power transients</b>	
RF frequency range	1 MHz to 1000 MHz
Display dynamic range	60 dB (for 47 dBm at input 1)
Scaling	2/5/10/20 dB/div
Triggering	internal, automatic (power 10%)
<b>Harmonic measurements (R&amp;S® CMS 54)</b>	
Display of 1st to 4th harmonic	
Max. harmonic frequency	1000 MHz
Dynamic range	>60 dB >90 dB in frequency range 26.965 MHz to 27.405 MHz (CB radio)
<b>Tracking generator (with R&amp;S® CMS-B59/-B9)</b>	
Frequency range	400 kHz to 1000 MHz
Reference level	-67 dBm to -27 dBm
Display dynamic range	50 dB
Span	0 to 50 MHz (full span for R&S® CMS 54)
Output level	-128 dBm to 0 dBm
Frequency offset	0 Hz to -999 MHz (depending on span and center frequency)
<b>Transmitter measurements at 2nd RF input</b>	
Measurement of RF frequency, modulation (AM, FM, φM), modulation frequency and RF spectrum (level) of small RF signals, e.g. in off-air or module measurements, for input levels from approximately	
RF frequency counter	30 μV (selective frequency counter with presetting)
Modulation meter	5 μV (IF narrow) 1 μV (IF narrow, selective meas.)
Selective level measurement	-75 dBm to -35 dBm without weighting filter, -100 dBm to -35 dBm with 2 kHz resonance filter
<b>Transmitter measurements at 2nd RF input (R&amp;S® CMS 54)</b>	
Additional, internally switchable 0/24 dB attenuator pad, for high-level measurements at input 2	

### Transmitter and receiver measurements

<b>Modulation generator I and II</b>	
Frequency range	0.1 Hz
Output voltage range	10 μV to 5 V
Output impedance	≤4 Ω
<b>Distortion meter</b>	
Frequency	100 Hz to 5 kHz (100 Hz to 3 kHz)
Measurement range	0.1% to 50%
<b>SINAD meter</b>	
Frequency	100 Hz to 5 kHz (1 kHz ±10Hz)
Measurement range	1 dB to 46 dB
<b>AF frequency counter</b>	
Operating modes	demodulation, AF, beat (frequency offset)
Frequency range	20 Hz to 500 kHz (20 Hz to 20 kHz) (superimposed RF)
Resolution	1 Hz/0.1 Hz
<b>Oscilloscope</b>	
Bandwidth	
DC	DC to 20 kHz
AC	10 Hz to 20 kHz

Horizontal deflection	20 to 0.1 ms/div
Vertical deflection	scaled in kHz (FM), rad (φM), % (AM), mV/V (AF)
Input voltage range	0 V to 40 V (V <sub>D</sub> )
Input impedance	approx. 1 MΩ
<b>AF filters</b>	
Highpass	f <sub>cutoff</sub> = 300 Hz
Lowpass	f <sub>cutoff</sub> = 3.4 Hz
<b>Bandpass</b>	
broadband	highpass + lowpass
narrowband	100 Hz to 3 kHz (50 Hz to 5 kHz)
Notch filter	100 Hz to 3 kHz (100 Hz to 5 kHz)
CCITT filter	see option R&S® CMS-B5 or R&S® CMS-B20
<b>Selective-call coder/decoder</b>	
Tone sequences	ZVEI1/ZVEI2/CCIR/EIA/EEA/EURO/NATEL/CCITT/VDEW/DTMF/VDEW direct dialling/user-defined sequences (DTMF decoding see Control Interfaces R&S® CMS-B5 and R&S® CMS-B55); CDCSS decoder and ATIS see option R&S® CMS-B27
<b>Audio monitor</b> (loudspeaker)	demodulated signal, AF signal, beat (frequency offset)

### General data

<b>Power supply</b>	
AC	100/120/220/240 V ±10%, 47 Hz to 420 Hz (50 VA)
DC	11 V to 32 V
Dimensions (W × H × D)	320 mm × 175 mm × 375 mm
Weight (without options)	13 kg

### Ordering information

<b>Radiocommunication Service Monitor</b>	R&S® CMS 50 R&S® CMS 54	0840.0009.50 0840.0009.54
<b>Extras</b>		
Documentation of Calibration Values	R&S® CMS-DCV	0240.2193.08
Memory Card 32 kByte	R&S® CMS-Z1	0841.1609.02
Memory Card 128 kByte	R&S® CMS-Z2	0841.1509.02
Battery Connector for external DC Supply	R&S® CMS-Z7	0841.1350.02
Adapter for VSWR Sensors R&S® NAS-Z1/-Z3/-Z5/-Z6/-Z7	R&S® CMS-Z37	1065.4907.02
Carrier-bag	R&S® CMS-Z40	1065.5603.02

## Antenna Coupler, RF Shielding Cover, *Bluetooth*<sup>®</sup> Antenna R&S<sup>®</sup> CMU-Z10/-Z11/-Z12, USB feed-through R&S<sup>®</sup> CMU-Z13

### Simple coupling and interference-free testing of mobile phones in all frequency bands

#### Brief description

Anyone engaged in mobile phone testing is only too familiar with problems such as getting hold of a suitable RF adapter or keeping RFI away which would otherwise falsify the measurement results. The R&S<sup>®</sup> CMU-Z10/-Z11/-Z12 is the solution to these problems for all mobile phones – whether GSM, US Cellular or WCDMA.

The broadband Antenna Coupler R&S<sup>®</sup> CMU-Z10 is the basis, which in conjunction with the RF Shielding Cover R&S<sup>®</sup> CMU-Z11 can be upgraded to a fully enclosed RF shielded chamber.

#### Antenna Coupler R&S<sup>®</sup> CMU-Z10

With increasing efforts to miniaturize mobile phones, the antenna disappears inside the enclosure. In recent mobile phone models, the antenna is replaced by a metallic-printed ceramic rod on the PC board or a printed structure in the cover. This radiating element is usually accommodated in the upper rear part of the phone. The fields emitted from there can ideally be picked up by an extensive coupling structure like that of the R&S<sup>®</sup> CMU-Z10.

#### Polarization

A  $\lambda/4$  radiator vertically mounted on the mobile phone generates a vertically polarized electromagnetic field. The coupling element in the R&S<sup>®</sup> CMU-Z10 is arranged so that a mobile phone with vertically mounted  $\lambda/4$  radiator achieves minimum coupling attenuation. The coupler is of asymmetrical design to allow also measurements on mobile phones with horizontal polarization.

#### Position

The blue circle shows the active coupling zone for frequencies from 770 MHz to 960 MHz, the green circle that for frequencies from 1.7 GHz to 2.2 GHz (see illustration). Depending on the radiation center of the phone, the optimum position is different for every model. Since the coupling zone is an area, the phone can be shifted somewhat out of the optimum position without dramatic increase in coupling attenuation (see diagram top right). These zones are marked on the coupler by the antenna elements which

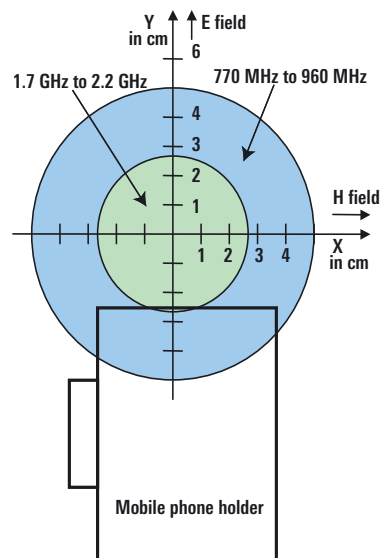

## Antenna Coupler, RF Shielding Cover, *Bluetooth*<sup>®</sup> Antenna R&S<sup>®</sup> CMU-Z10/-Z11/-Z12, USB feed-through R&S<sup>®</sup> CMU-Z13

are visible through the transparent base plate. To facilitate handling of the DUT, a holder is mounted on the base plate for fixing the mobile phones directly above the optimum coupling zone. For applications in which this holder is disturbing, a second absolutely flat base plate is supplied, which can be used instead of the base plate mounted as standard. This base plate can accommodate DUTs of up to 280 mm × 50 mm × 200 mm in size.

### Data connection

A 15-pin sub-D feed-through is installed as standard to connect a data cable. A USB feed-through can optionally be ordered.

### Mismatch

In order to minimize RF power loss on the way to the radiocommunication tester (e.g. R&S<sup>®</sup> CMU200), the high-quality cable that comes with the R&S<sup>®</sup> CMU-Z10 should be used.

### Radiated interference

Interference from other transmitters falsifies the measurement results. Interfering transmitters may be neighbouring base stations as well as other mobile phones and test sets in the same service shop or repair line. Distinctly differing results of bit error rate measurements (BER) in different channels are a clear sign of interference.

### Shielding Cover R&S<sup>®</sup> CMU-Z11

With the shielding cover, the coupler is upgraded to a high-grade RF shielded chamber which prevents unwanted interference radiated by base stations or other neighbouring test and service sets from affecting the measurement results of the DUT. This is particularly important for BER measurements. The effective closing mechanism can conveniently be managed with only one hand and ensures a very high shielding effectiveness of >50 dB by producing a defined contact pressure.

## Specifications

R&S <sup>®</sup> CMU-Z10	
VSWR without R&S <sup>®</sup> CMU-Z11, without DUT, with cable supplied	
0.77 GHz to 0.87 GHz	<5.0
0.87 GHz to 0.96 GHz	<3.5
1.7 GHz to 2.0 GHz	<3.5
2.0 GHz to 2.2 GHz	<3.5
Coupling factor	
770 MHz to 960 MHz	5 dB to 8 dB <sup>1)</sup>
1.7 GHz to 2.2 GHz	10 dB to 15 dB
Connectors	
RF IN/OUT	N female/N female
RF THROUGH	N female/N female
DATA THROUGH	15-pin HDD female filter adapter/ 15-pin HDD male filter adapter
R&S <sup>®</sup> CMU-Z11	
Shielding effectiveness (in conjunction with R&S <sup>®</sup> CMU-Z11)	
Antenna coupler	>50 dB
<i>Bluetooth</i> Antenna R&S <sup>®</sup> CMU-Z12	>30 dB
R&S <sup>®</sup> CMU-Z12	
VSWR	
2.4 GHz to 2.5 GHz	<2.5
Connector	N female
The <i>Bluetooth</i> antenna can be integrated into the R&S <sup>®</sup> CMU-Z10 or used separately.	
General data	
Operating temperature range	-10°C to +60°C
Dimensions (W × H × D)	
R&S <sup>®</sup> CMU-Z10	230 mm × 100 mm × 320 mm
R&S <sup>®</sup> CMU-Z10 with R&S <sup>®</sup> CMU-Z11	250 mm × 180 mm × 430 mm

Usable test space	
(2nd plate without holder)	280 mm × 50 mm × 200 mm
R&S <sup>®</sup> CMU-Z12	56 mm × 56 mm × 50 mm
Weight	
R&S <sup>®</sup> CMU-Z10	2.7 kg
R&S <sup>®</sup> CMU-Z10 with R&S <sup>®</sup> CMU-Z11	4.8 kg
R&S <sup>®</sup> CMU-Z12, R&S <sup>®</sup> CMU-Z13	0.1 kg

1) The specified coupling factor is based on measurements carried out on several mobile phones of different manufacturers. The values cannot be warranted since they also depend on the antenna pattern of the mobile part.

## Ordering information

Antenna Coupler	R&S <sup>®</sup> CMU-Z10	1150.0801.02
RF Shielding Cover for R&S <sup>®</sup> CMU-Z10	R&S <sup>®</sup> CMU-Z11	1150.1008.02
<i>Bluetooth</i> Antenna	R&S <sup>®</sup> CMU-Z12	1150.1043.02
USB feed-through	R&S <sup>®</sup> CMU-Z13	on request
Spare RF sealing cord for R&S <sup>®</sup> CMU-Z11		1158.9514.00

If you order the Antenna Coupler R&S<sup>®</sup> CMU-Z10 plus the Shielding Cover R&S<sup>®</sup> CMU-Z11 and/or the *Bluetooth* Antenna R&S<sup>®</sup> CMU-Z12, the shielded chamber comes ready mounted. All components are also available individually for upgrading. If the options R&S<sup>®</sup> CMU-Z11 and/or -Z12 are not to be factory-fitted to the Antenna Coupler R&S<sup>®</sup> CMU-Z10, please use a separate order for these options.

### Equipment supplied

**R&S<sup>®</sup> CMU-Z10:** coupler (basis for shielded chamber), cable RG-214 with 2 N male connectors, length approx. 120 cm, 2nd base plate made of plexiglass without holder for optional use instead of the mounted base plate with holder.

**R&S<sup>®</sup> CMU-Z11:** shielding cover for the antenna coupler, hinges for fixing it to the coupler.



Contents Overview

Chapter Overview

Type Index

R&S Addresses

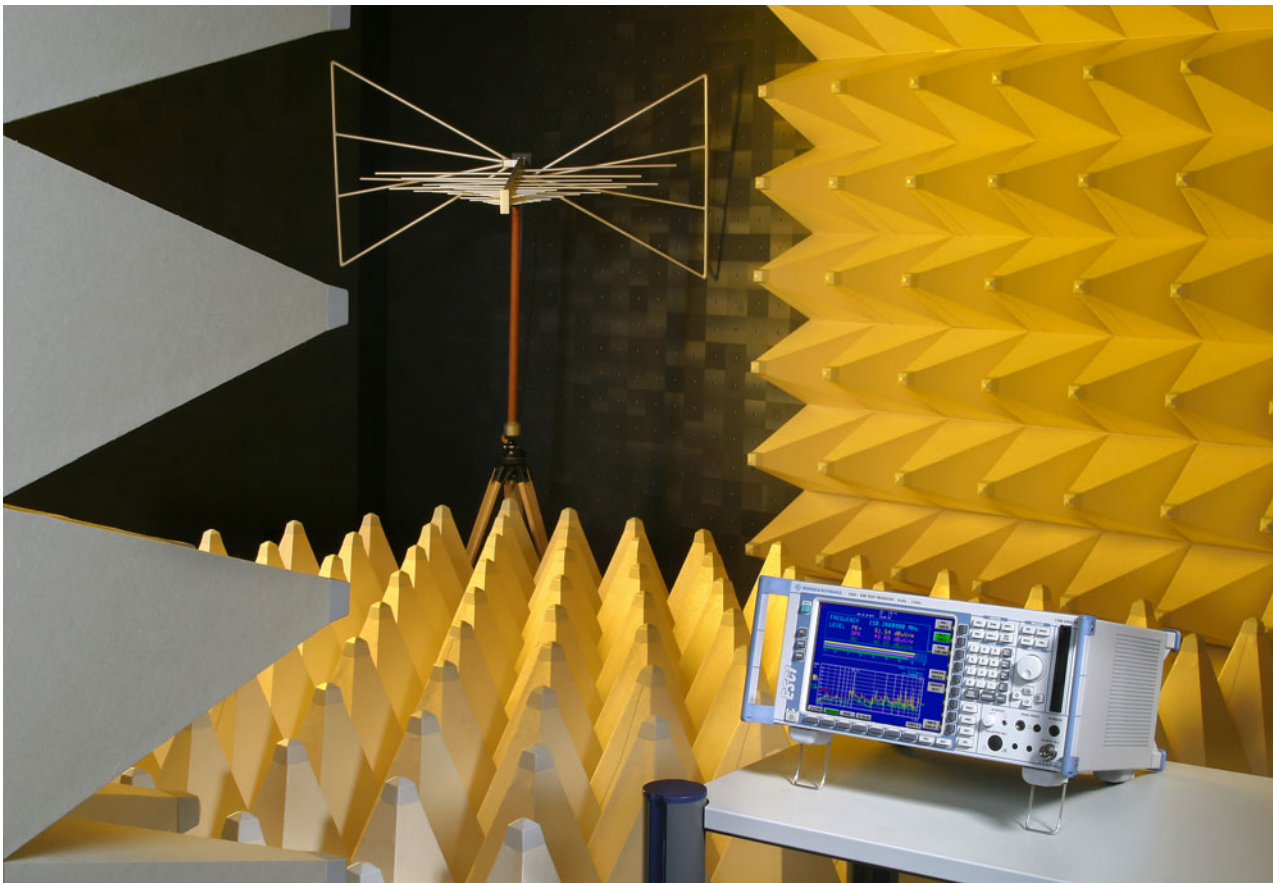

*R&S® ESCI, which is a compact EMI test receiver for conformity measurements to all civil standards from 9 kHz to 3 GHz*



Contents Overview

Chapter Overview

Type Index

R&S Addresses



◀	Contents Overview	Chapter Overview	Type Index	R&S Addresses	▶
---	-------------------	------------------	------------	---------------	---

## Contents of Chapter 2

Designation	Type	Description	Page
<b>Introduction</b>			56
<b>Equipment for EMI measurements to specific standards</b>			60
<b>EMI Test Receivers</b>			
9 kHz to 3 GHz 9 kHz to 7 GHz	R&S®ESPI3 R&S®ESPI7	Specially designed for precompliance measurements in development	62
9 kHz to 3 GHz	R&S®ESCI	Compact EMI test receiver for Conformity measurements to all civil standards	66
20 Hz to 7/26.5/40 GHz	R&S®ESIB7/26/40	EMI test receiver and spectrum analyzer all in one. Commercial/military EMI measurements, spectrum/network analyses in different frequency ranges	70
	R&S®ESIB-B2		Internal Preamplifier 74
<b>Signal Test Receivers</b>			
10 kHz to 3 GHz	R&S®EB200	Portable monitoring with Handheld Directional Antenna R&S®HE200	75
<b>Coverage Test Receivers</b>			
9 kHz to 3 GHz 9 kHz to 7 GHz	R&S®ESPI3 + R&S®ESPI-K50 R&S®ESPI7 + R&S®ESPI-K50	Field-strength measurements in mobile communications networks and terrestrial broadcast networks	62
<b>EMI Test Software</b>			
	R&S®ES-K1	Fully automatic measurement of conducted and radiated emissions to international commercial and military standards	78
	R&S®EMC32	For use in development, for compliance and batch testing	80
	R&S®EMC32-E+	EMI Measurement Software	82
	R&S®ESxS-K1	Low-cost remote-control display	84
<b>EMC Test Accessories</b>			
Absorbing Clamps, Ferrite Clamp	R&S®MDS-21, R&S®MDS-22, R&S®EZ-24		85
Triple-Loop Antenna	R&S®HM020		87
Active Antennas	R&S®AM524, R&S®HM525		88
Shielded, Calibrated Magnetic Field Pickup Coil	R&S®HZ-10		89
Probe SEN (E and H Field)	R&S®HZ-11, R&S®HZ-14		90
Precision Halfwave Dipole SEN	R&S®HZ-12, R&S®HZ-13		92
Active Dipole Antennas	R&S®HE202, R&S®HE302		93
HF Antennas; Power Supply (for remote feeding)	R&S®HFH2-Z2/-Z4/-Z6, R&S®HZ-9		94
VHF, UHF and SHF Antennas, RF Probe	R&S®HK116, R&S®HL223, R&S®HL023A1, R&S®HL040/050, R&S®HL562, R&S®HF906		98
Broadband Dipole, Tripods, Mast (manual)	R&S®HUF-Z1, R&S®HFU-Z, R&S®HZ-1		99
V-Networks	R&S®ESH2-Z5, R&S®ESH3-Z6, R&S®ENV216, R&S®ENV4200		102
Coupling Networks	R&S®ENY22, R&S®ENY41		104
Antenna Impedance Converter	R&S®EZ-12, R&S®EZ-17		105
150 kHz Highpass	R&S®EZ-25		106
Current Probes, Pulse Limiter, Attenuator	R&S®ESV-Z1, R&S®ESH3-Z2		106
Probes, Attenuators and RF Cables	R&S®ESH-Z2/-Z3, R&S®ESH2Z31, R&S®HFU, R&S®HZ3, R&S®HZ4		107
<b>Test Systems and Supplementary Equipment in other Chapters</b>			
EMC, EMI, EMS Test System Families	R&S®TS997..., R&S®TS998...		355
Field-Strength Measurement Systems	R&S®TS995...		336
Signal Generators	R&S®SM...		225

◀	Contents Overview	Chapter Overview	Type Index	R&S Addresses	▶
---	-------------------	------------------	------------	---------------	---



Contents Overview

Chapter Overview

Type Index

R&amp;S Addresses



## Introduction

### EMC = EMI + EMS

Electromagnetic compatibility (EMC) is the capability of an electrical device or system to operate in its electromagnetic environment without disturbing or being disturbed by it. EMC is an important criterion of product quality. To ensure EMC of a product in the most economical way, appropriate measures should be taken as early as in the design phase.

According to the definition, EMC is subdivided into electromagnetic interference (EMI) and electromagnetic immunity or susceptibility (EMS). Legislation prescribes compliance with maximum values for EMI and minimum values for EMS. The relevant limit values, the measurement methods and instruments to be employed are specified in the relevant standards.

#### Conformity mark

To show their conformity to the EMC requirements prescribed by law, all electrical devices have to be marked accordingly.



European CE conformity mark

Since beginning of 1996 uniform marking is prescribed for the European Economic Area (EEA). From that date on electrical and electronic equipment not bearing the CE conformity mark may not be marketed any more in the whole European economic area.

### EMI measurements

For measuring the electromagnetic interference, the interference sink, which in the commercial sector is always the listener or viewer, is replaced by the measuring instrument. As a result, all test receivers for commercial EMI measurements should have man-like response built-in: they must have a quasi-peak-weighting detector to show the human perception of interference as a measured value.

In the military sector the interference sink is assumed to be a technical device which responds to the maximum interference level. Therefore, the peak level of interference is measured.

Interference is emitted by the equipment under test in completely undefined ways. Therefore, the EMC standards contain regulations for coupling the test receiver to the equipment under test, for the environment of the EUT and its operation.

### EMS measurements

For measuring the electromagnetic susceptibility, the different interference sources occurring in practice are replaced by appropriate generators, the interfering signals of which are applied to the EUT via suitable coupling/decoupling networks.

For monitoring the proper functioning of the EUT, suitable monitoring equipment can be provided, which so far has not been defined in the relevant EMC standards. In many cases, highly shielded video cameras with a monitor are used for this purpose.

### EMC measurement software

Reproducible EMC measurements are only possible upon strict compliance with a number of rules and standards for the measuring instruments used and for the measurement methods adopted.

EMI test equipment from Rohde&Schwarz complies with the relevant standards for measuring instruments. Compliance with the prescribed measurement methods, however, is the user's own problem. Support is rendered in the form of special measurement software allowing time-saving and correct measurements.

A number of measurement software packages is available (R&S®ES-K1, R&S®EMC32-E and R&S®ESxS-K1 for EMI measurements and R&S®EMC32-S for EMS measurements). They relieve the user of routine settings and offer every convenience from automatic consideration of frequency-dependent transducer factors of the coupling/decoupling networks, automatic selection of the applicable limit lines, display of the results in graphical or tabular form through to the generation of test reports. Similar convenience is provided by the automatic EMI test routines implemented in the Test Receivers of the R&S®ESCI, R&S®ESIB and R&S®ESPI series. They allow fully automatic time-saving measurements without an external controller, so that extremely compact test procedures can be implemented.



Contents Overview

Chapter Overview

Type Index

R&amp;S Addresses







Contents Overview

Chapter Overview

Type Index

R&amp;S Addresses



## Introduction

### EMC measuring instruments

Rohde&Schwarz not only offers suitable test receivers covering a frequency range from 20 Hz to 40 GHz for EMI measurements, but also the necessary accessories. In the range from 9 kHz to 3 GHz, different types of test receivers of the R&S®ESCI and R&S®ESPI families are available. The frequency range of the R&S®ESIB receivers starts at 20 Hz and extends to 7 GHz, 26.5 GHz or 40 GHz. There is the right instrument for every application and measurement problem, from the precertification test receiver R&S®ESPI for development-accompanying diagnostic measurements through to the high-end R&S®ESIB.

Line impedance stabilization networks (LISN) are required as coupling/decoupling networks for conducted emission measurements on power lines in the frequency range from 9 kHz to 30 MHz. These are available for a current drain of up to 16 A for two-phase feeding and up to 200 A for three-phase feeding of the EUTs. Symmetrical LISNs are available for RFI voltage measurements on data lines which are becoming ever more important.

Radiated emission is measured above 30 MHz, with calibrated antennas being required. The Rohde&Schwarz range of products comprises various high-precision antennas, as well as absorbing clamps, which are required for RFI power measurements e.g. on household appliances. For EMS measurements, the Rohde&Schwarz range of products includes signal generators whose modulation and level control characteristics are tailored to the specific requirements of these measurements. Suitable antennas and power meters are also available.

### EMC test systems

Planning and implementation of practice-oriented EMC test systems requires a great deal of specialized knowledge and experience. This is what Rohde&Schwarz specialists have. All their expertise goes into turnkey EMC test systems which provide the fastest way of yielding correct EMC measurements. These systems are always tailored to the specific needs of the customer to provide the optimum solution to the tasks on hand. We can offer everything from small systems through to complete equipment of test houses with shielded anechoic chamber and the complete infrastructure required. Naturally, the main emphasis is on fully automatic measurements with comprehensive documentation of the test results and, if desired, statistical evaluation. One of the important factors of automatic EMC test systems is calibration and continuous monitoring of the measurement accuracy to make sure that all test results will pass a verification compliance test.

### EMC seminars

Successful work in the field of EMC requires an accurate knowledge of all the relevant regulations, laws, standards and techniques required. It is not easy to be familiar with all of them and – in view of the frequent modifications – to remain up to date. Support is given in the form of seminars, in which experts both from Rohde&Schwarz and from outside will impart the necessary knowledge to the participants. These seminars are held at the training center in Munich, but are also offered at various Rohde&Schwarz branch offices; or also directly at the customer's if there is such a demand.

### EMC legislation and standards

For the European Economic Area (EEA) EMC is regulated in the "Council Directive of 3 May 1989 on the approximation of the laws of Member States relating to electromagnetic compatibility (89/336/EEC)", which was published in the Official Journal of the EU on 23 May 1989.

In the meantime this directive has been updated and transformed into national laws in all EEA member states, e.g. in Germany into the "Law on Electromagnetic Compatibility" (EMVG) of 25 September 1998.

The directive prescribes "protection goals" for all equipment containing electric or electronic components. These protection goals apply to EMI as well as to EMS. The directive does not contain any EMC limits, but refers to the appropriate standards. It is assumed that compliance with these standards entails compliance with the protection goals.

In order to be recognized by the directive and the EMVG, the numbers ("sources") of EMC standards must be published in the Official Journal of the European Communities or the Official Journal of Posts and Telecommunications.



Contents Overview

Chapter Overview

Type Index

R&amp;S Addresses





Contents Overview

Chapter Overview

Type Index

R&amp;S Addresses



## Introduction

### EMC standards

The number of standards published in the Official Journals is steadily increasing. The different types of standards include "generic standards", which are to be applied in all cases which are not covered by specific product or product family standards. The product (family) standards are divided into standards limiting low-frequency and high-frequency emission (radio disturbance suppression) and standards defining the requirements of immunity to electromagnetic emission. Besides, there is a series of specific product standards defining EMC requirements.

#### Individual EMC standards (extract of Official Journal 12/2002):

##### Generic standards – emission

- ◆ **EN 61000-6-3:** Residential, commercial and light industry environment
- ◆ **EN 61000-6-4:** Industrial environment

##### Generic standards – immunity

- ◆ **EN 61000-6-1:** Residential, commercial and light industry environment
- ◆ **EN 61000-6-2:** Industrial environment

##### Product family standards and product standards for low-frequency emission

- ◆ **EN 61 000-3-2:** EMC Part 3-2: Limits for harmonics up to 16 A
- ◆ **EN 61 000-3-3:** EMC Part 3-3: Limits for voltage fluctuations and flicker up to 16 A
- ◆ **EN 61000-3-11:** EMC Part 3-11: Limits for upper oscillation currents and voltage variations up to 75 A

##### Product family standards for high-frequency emission

- ◆ **EN 55011:** ISM equipment
- ◆ **EN 55012:** Vehicles, internal combustion engines
- ◆ **EN 55013:** Sound and TV broadcast receivers
- ◆ **EN 55014-1:** Household appliances and electric tools
- ◆ **EN 55015:** lighting equipment
- ◆ **EN 55022:** Information technology equipment
- ◆ **EN 55103-1:** Audio and video equipment

##### Product standards for immunity

- ◆ **EN 55014-2:** Household appliances, tools and similar apparatus
- ◆ **EN 61547:** Lighting equipment
- ◆ **EN 55020:** Sound and TV broadcast receivers
- ◆ **EN 55024:** Informatics equipment
- ◆ **EN 55103-2:** Audio and video equipment

##### Special standard for signal transmission in low voltage installations

- ◆ **EN 50065-1:** Signalling on low-voltage electrical installations, Part 1: General requirements, frequency bands and electromagnetic disturbances

##### Product standards containing EMC requirements

- ◆ **EN 50083-2:** Cable distribution systems for TV and sound signals
- ◆ **EN 50090-2-2:** Electrical system technique for home and buildings
- ◆ **EN 50091-2:** Uninterruptible power systems (UPS);
- ◆ **EN 50 130-4:** Alarm systems
- ◆ **EN 50 148:** Electronic taximeters

- ◆ **EN 50199:** Light arch welding equipment
- ◆ **EN 50227:** Nearing sensors
- ◆ **EN 50263:** Measuring relays
- ◆ **EN 50270:** Gas sensors
- ◆ **EN 50293:** Traffic signals
- ◆ **EN 60204-31:** Sewing machines
- ◆ **EN 60439-1, EN 60947-x-x, EN 50295:** Low voltage switchgear and control gear
- ◆ **EN 60521, EN 60687, EN 61036, EN 61268:** Several AC watt-hour meters
- ◆ **EN 60601-1-2:** Medical electrical apparatus, General safety requirements – EMC requirements and tests
- ◆ **EN 60669-2-x:** Electronic switches for household and similar
- ◆ **EN 60730-x-x:** Automatic electric controls for household and similar use
- ◆ **EN 60870-2-1:** Telecontrol equipment and systems
- ◆ **EN 60945:** Maritime navigational equipment
- ◆ **EN 61008-1, EN 61009-1, EN 61543:** Residual current circuit breakers
- ◆ **EN 61037:** Electronic ripple control receivers for tariff and load control
- ◆ **EN 61038:** Time switches for tariff and load control
- ◆ **EN 61 131-2:** Programmable controllers
- ◆ **EN 61326:** Electrical equipment for measurement and test, control and laboratory use
- ◆ **EN 61 800-3:** Adjustable speed electrical power drive systems
- ◆ **EN 12015, EN 12016:** Elevators and escalators
- ◆ **EN ISO 14982:** Agricultural and forestry machines
- ◆ **EN 300386:** Telecommunications network equipment



Contents Overview

Chapter Overview

Type Index

R&amp;S Addresses



[Contents Overview](#)[Chapter Overview](#)[Type Index](#)[R&S Addresses](#)

## Introduction

### EMC standards for radio and telecommunication equipment

According to the European R&TTE Directive that took effect on 7 April 1999, standards for radio equipment and telecommunications terminal equipment are listed in the Official Journal. The R&TTE Directive was incorporated into the German Law on Radio Equipment and Telecommunications Terminal Equipment (FTEG). These include the ETSI standards EN30x xxx, e.g. EN301489 radio sets. So far, 52 of these standards have been published in the Official Journal. EMC test methods.

As already described above, since January 1996 all electrical products offered on the EEA market must be identified with the CE mark, the prerequisite for this conformity mark being compliance with the relevant EMC standards.

The EMC directive prescribes different test methods, depending on whether the equipment tested is "normal" equipment; it is also of importance whether complete standards, i.e. relating to both EMI and EMS, exist for that equipment.

In the simplest possible case, i.e. if a complete standard is available, the manufacturer or importer in the EEA is authorized to carry out the required tests himself and to label the product with the CE mark without supervision. Incomplete standards, however, require the involvement of a competent body.

All in all, the EMC and R&TTE directives give the manufacturer or importer more possibilities than previously to pursue independently the certification of the electromagnetic compatibility of his products, which is then recognized on the entire European market.

### Field-strength measurements

Wide measurement ranges (30 nV to 7 V) in conjunction with high selectivity and large dynamic range permit the Rohde&Schwarz test receivers to be used as high-accuracy selective voltmeters in labs and test departments. With built-in tracking generators, the test receivers can also perform twoport measurements. Antennas make them suitable for field-strength measurements.

Radiocommunication services (regulation authorities, broadcasting corporations, military, traffic and security authorities as well as civil providers) use field-strength meters for radio control and propagation measurements in the planning stage and for coverage measurements during operation of communication networks.

Field-strength measurements – in particular propagation and coverage measurements – are usually made in mobile mode (vehicle or helicopter). Portability and battery operation are important criteria in the choice of the test receiver.

### Hardware from Rohde&Schwarz

Rohde&Schwarz offers the complete range of measuring equipment from a single source: from automatic test receivers through to turnkey systems with power amplifiers and remote-controlled antennas. The Rohde&Schwarz products feature future-oriented design and advanced circuit technology; they comply with the highest international standards both electrically and mechanically.

### Software from Rohde&Schwarz

For years Rohde&Schwarz has been creating programs which are extremely user-friendly and can be used without any in-depth programming knowledge. Using modern software development tools and in close cooperation with the customers, program packages are tailored to the specific needs.

[Contents Overview](#)[Chapter Overview](#)[Type Index](#)[R&S Addresses](#)

# Equipment required for EMI measurements to specific standards

Contents Overview

Chapter Overview

Type Index

## Group of equipment

Standards		Industrial, scientific and medical equipment	Vehicles with combustion engines, remote/built-in RF suppression	Sound and TV broadcast receivers	Electrical devices, household appliances and tools	Fluorescent lamps and luminaires	Information technology equipment (ITE)	Military equipment and systems	Generic emission standards	Mains signalling equipment	Cable distribution systems, TV/sound	Uninterruptible power systems (UPS)	Professional audio/video equipm.	Electric railways	Medical electrical apparatus	Maritime navigation equipment
Frequency range	Test Receivers	Accessories and extras														
from 20 Hz	ESIB	Current Probe EZ-17 H-Field Coil HZ-10						●					●			
from 9 kHz	ESIB	Current Probe EZ-17 H-Field Coil HZ-10 Tripod HFU-Z Loop Antenna HFH2-Z2 Tripod HZ-1 Rod Antenna HFH2-Z6	○	○	○	○	●	●	○	○			●			
	ESCI	V-Network ESH2-Z5 V-Network ENV216			●	●	●	● <sup>b)</sup>	●	● <sup>c)</sup>	●	●	●	●	●	●
	ESPI <sup>1)</sup>	V-Network ENV 4200			●	●	●	● <sup>b)</sup>	●	● <sup>c)</sup>	●	●	●	●	●	●
	ESIB	V-Network ESH3-Z6 Coupling Network ENY22 Coupling Network ENY41 Probe ESH2-Z2 Probe ESH2-Z3 Ant. Imp. Converter EZ-12 Probe Set EZ-11 Probe Set EZ-14 Triple-Loop Ant. HM 020 RF Cable HZ-3/HZ-4	●		●	●	●	● <sup>b)</sup>	●	● <sup>c)</sup>	●	●	●	●	●	●
from 30 MHz	ESIB	Current Probe EZ-17 Current Probe ESV-Z1 Absorb. Clamp MDS-21/22 Probe Set HZ-11 Probe Set HZ-14 Tripod, Mast HFU-Z Broadband Dipole HUF-Z1 Log Periodic Ant. HL023A1 Biconical Antenna HK 116 Log Periodic Ant. HL223 Con. Log Spir. Ant. HUF-Z4 Tripod HZ-1 RF Cable HFU2-Z4/-Z5 Shielded TEM-Line S-LINE	○	○	○	○	○	●	●	○	○	○	○	○	○	○
	ESCI	Probe Set HZ-11 Probe Set HZ-14	○	○	○	○	○	○	○	○	○	○	○	○	○	○
	ESPI <sup>1)</sup>	Tripod, Mast HFU-Z Broadband Dipole HUF-Z1 Log Periodic Ant. HL023A1	●	●	●	●	●	●	●	●	●	●	●	●	●	●
	ESIB	Biconical Antenna HK 116 Log Periodic Ant. HL223 Con. Log Spir. Ant. HUF-Z4 Tripod HZ-1 RF Cable HFU2-Z4/-Z5 Shielded TEM-Line S-LINE	●	●	●	●	●	● <sup>f)</sup>	●	●	●	●	●	●	●	●
from 1 GHz	ESPI ESCI ESIB	Antennas HL050, AC008 on request	●		●		● <sup>2)</sup>	●			●					
from 2 GHz	ESIB	Antennas HL050, AC008 on request	●		●		● <sup>3)</sup>	●			●					
from 5 GHz	ESIB 26 ESIB 40	Antennas HL050, AC008 on request	●				●	●			●					
from 10 GHz	ESIB 26 ESIB 40	Antennas HL050, AC008 on request	●				●	●			●					
from 18 GHz to 40 GHz	ESIB 40	Accessories on request						● <sup>**</sup> ● <sup>***</sup>			●					

1) ESPC has limited compliance with CISPR 16-1.

2) FCC: clock frequency <200 MHz.

3) FCC: clock frequency <500 MHz.

4) VG up to 200 kHz.

5) VG.

6) VG, MIL.

## Equipment required for EMI measurements to specific standards

◀ ▶

[Contents Overview](#)

[Chapter Overview](#)

[Type Index](#)

EN 60 947-x-x	EN 300 127	EN 300 220, 330, 440 EN 301489-3	EN 301489-5 EN 301489-6	EN 300339 EN 301489-1	ETS 300340	EN 301489-7 EN 302018-2	EN 300385 EN 301489-4	ETS 300386-1 EN 300 386-2	EN 301489-9	EN 301489-10	EN 301489-11 ETS 300384/447	EN 301489-12	EN 301489-13	EN 300 741 EN 301489-2	EN 301489-15	EN 301783-2	EN 301489-16	EN 301489-17	EN 301489-18	EN 301843-2	EN 300 829	EN 301489-19	EN 300 831 EN 301489-20	EN 300 832 EN 301721	Legend	
Low-voltage switchgear and control gear	Telecom Systems of large dimensions	Short range devices (SRD) 9 kHz to 40 GHz	PMR equipment	Generic EMC standard for radio equipment	ERMES paging receivers	GSM 900 MHz GSM 1800 MHz	Fixed radio links	Equipment of tele-communication networks	Wireless microphones and similar equipment	Second generation cordless telephones (CT2)	VHF FM broadcasting transmitters	VSAI, SNG and TES equipment	CB radio and ancillary equipment	On-site and wide-area paging equipment	Commercially available amateur radio equipment	Analog cellular radio comm. equipment	2.6 GHz wideband trans- mission and HIPERLAN	TETRA and ancillary equipment	VHF maritime mobile radio telephone	1.5 GHz maritime MES with LBRDC for GMDSS	1.5 GHz receive-only MES for data comm.	1.5/2/2.5 GHz MES for satellite GSM	<1 GHz MES with LBRDC using LEDs		● necessary accessory ○ recommended extra * 10 GHz = upper freq. limit to GAM-EG 13 ** 18 GHz = upper freq. limit to CISPR 11, VG standards and DEF-STAN 59-41 *** 40 GHz = upper frequency limit to ANSI C63.2, C63.4 and MIL-STD-461 Further European standards see page 58	
																									Current probe 5 Hz to 2 MHz/20 Hz to 100 MHz	
		●																								Shielded, calibrated field coil 5 Hz to 10 MHz
																										Current probe 20 Hz to 100 MHz
		●																								Shielded, calibrated field coil 5 Hz to 10 MHz
		●																		●						Tripod for Loop Antenna HFH2-Z2
																				●						Active loop antenna 9 kHz to 30 MHz
																										Tripod for Rod Antenna HFH2-Z6
																										Active rod antenna 9 kHz to 30 MHz
●		●	●	●	●	●	●	●	●	●	●	●	●	●	●	●	●	●	●	●	●	●	●	●	●	V-network up to 25 A (70 A), 4-line LISN
●		●	●	●	●	●	●	●	●	●	●	●	●	●	●	●	●	●	●	●	●	●	●	●	●	V-network up to 16 A, 2-line LISN
●		●	●	●	●	●	●	●	●	●	●	●	●	●	●	●	●	●	●	●	●	●	●	●	●	V-network up to 200 A, 4-line LISN
			●	●							●	●														V-network up to 150 A (500 A), single-phase LISN
								○																		2-wire Coupling Network
								○																		4-wire Coupling Network)
●		●	●	●	●	●	●	●	●	●	●	●	●	●	●	●	●	●	●	●	●	●	●	●	●	Active probe for RFI voltage measurement
●		●	●	●	●	●	●	●	●	●	●	●	●	●	●	●	●	●	●	●	●	●	●	●	●	Passive probe for RFI voltage measurement
																										Antenna impedance converter 9 kHz to 30 MHz
○		○	○	○	○	○	○	○	○	○	○	○	○	○	○	○	○	○	○	○	○	○	○	○	○	Near-field probe set 100 kHz to 2 GHz
○		○	○	○	○	○	○	○	○	○	○	○	○	○	○	○	○	○	○	○	○	○	○	○	○	Near-field probe set 9 kHz to 1 GHz
		○																			○	○				Triple-loop antenna 9 kHz to 30 MHz
																										Low-loss coaxial cables 3 m/10 m
																										Current probe 20 Hz to 100 MHz
																										Current probe 20 to 300 MHz (cal. up to 600 MHz)
																										Absorbing clamp 30 to 1000 MHz
○		○	○	○	○	○	○	○	○	○	○	○	○	○	○	○	○	○	○	○	○	○	○	○	○	Near-field probe set 100 kHz to 2 GHz
○		○	○	○	○	○	○	○	○	○	○	○	○	○	○	○	○	○	○	○	○	○	○	○	○	Near-field probe set 9 kHz to 1 GHz
																										Absorbing Clamp Slideway HCA f. autom. meas.
●	●	●	●	●	●	●	●	●	●	●	●	●	●	●	●	●	●	●	●	●	●	●	●	●	●	Broadband dipoles 20 to 80 MHz
●	●	●	●	●	●	●	●	●	●	●	●	●	●	●	●	●	●	●	●	●	●	●	●	●	●	Log-periodic antenna 80 to 1300 MHz
●	●	●	●	●	●	●	●	●	●	●	●	●	●	●	●	●	●	●	●	●	●	●	●	●	●	Biconical antenna 30 to 300 MHz
●	●	●	●	●	●	●	●	●	●	●	●	●	●	●	●	●	●	●	●	●	●	●	●	●	●	Log-periodic antenna 200 to 1300 MHz
																										Conical log spiral antenna 200 to 1000 MHz
																										Tripod for HK116, HL223 and HUF-Z4
●	●	●	●	●	●	●	●	●	●	●	●	●	●	●	●	●	●	●	●	●	●	●	●	●	●	RF connecting cable 12 m/7 m, common-mode suppr.
		○	○	○	○	○		○	○				○	○	○	○										Shielded TEM-Line, 0.15 to 1000 MHz (2 models)
		●													●											Log-periodic antenna/directional ant. 1 to 18 GHz e.g. double-ridged waveguide horn antennas
		●													●											Log-periodic antenna/directional ant. 1 to 18 GHz e.g. double-ridged waveguide horn ant.
		●													●											Log-periodic antenna/directional ant. 1 to 18 GHz e.g. double-ridged waveguide horn antennas
		●													●											Log-periodic antenna/directional ant. 1 to 18 GHz e.g. double-ridged waveguide horn ant.
		●													●											Double-ridged waveguide horn antenna

7) VG, DEF-STAN.

8) MIL-STD-461 C.

9) see R&amp;S®EZ-25.

## Test Receiver R&S® ESPI

**R&S® ESPI 3: 9 kHz to 3 GHz**

**R&S® ESPI 7: 9 kHz to 7 GHz**

**The precompliance standard**

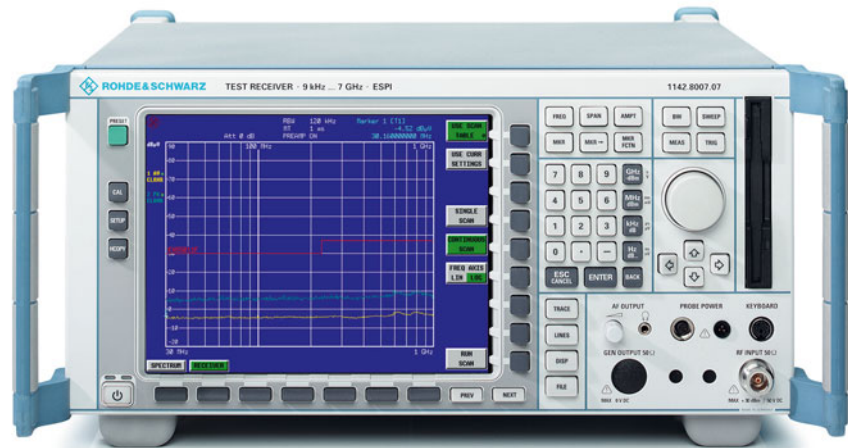

### Brief description

The **R&S® ESPI3** and **R&S® ESPI7**, which are suitable for all commercial EMI standards to CISPR, EN, ETS, FCC, ANSI C63.4, VCCI and VDE, have been specially designed for precompliance measurements in development.

Both models are based on the modern Spectrum Analyzer Family R&S® FSP. They combine the complete repertoire of a high-end analyzer with that of a conventional test receiver in a manner that sets new standards with respect to versatility and performance in precompliance testing. This makes the final compliance test purely a formality. This combination makes the R&S® ESPI equally well-suited for general tasks in spectrum analysis as well as for special EMI diagnostics, providing an ideal instrument for any development laboratory or other facility that does not need to perform measurements in absolute conformity with the strict CISPR requirements. The objective is to perform and document EMC diagnostic measurements on the equipment under test as quickly as possible and as accurately as necessary.

### Main features

#### Excellent test receiver features

- ◆ Peak, Quasi-Peak, RMS and AV (max. 3 detectors simultaneously)
- ◆ EMI measurement bandwidths 200 Hz, 9 kHz, 120 kHz, 1 MHz
- ◆ Correct pulse weighting to CISPR 16-1 from PRF of **10 Hz**
- ◆ For all commercial EMI standards such as CISPR, EN, ETS, FCC, ANSI C63.4, VCCI and VDE

#### Extremely high measurement speed

- ◆ Fast detection of critical frequencies through overview measurements:
  - Measurement time 100  $\mu$ s to 100 s in receiver mode
  - up to 16000 s in analyzer mode
- ◆ Fast measurements in the time domain: minimum sweep time 1  $\mu$ s

#### Spectrum analyzer

- ◆ Resolution bandwidths from 10 Hz to 10 MHz (in 1/3/10 sequence)
- ◆ RMS detector for measurements on digitally modulated signals
- ◆ Test routines for TOI, ACPR, OBW, amplitude statistics
- ◆ Gated sweep for measurements on TDMA signals

#### Outstanding performance features

- ◆ Total measurement uncertainty
  - Spectrum analyzer mode: 0.5 dB (without preselection)
  - Receiver mode: <1.5 dB
- ◆ Displayed average noise level (DANL): **-155 dBm** (1 Hz),  $f < 1$  GHz
- ◆ Phase noise of -145 dBc (1 Hz) typ. at an offset of 10 MHz provides optimum conditions for ACPR measurements on WCDMA systems
- ◆ NF = 21.5 dB (12 dB with preamplifier option R&S® ESPI-B2)
- ◆ User-programmable scan tables
- ◆ Display of results and comparison with standard-conformal limit lines
- ◆ Correction values for cable loss, coupling networks and antennas included as transducer factor
- ◆ Data reduction and modification of a frequency list for weighted final measurement
- ◆ Bargraph display for different types of detectors
- ◆ Automatic overload monitoring
- ◆ Built-in AF demodulation
- ◆ EMI bandwidths to CISPR
- ◆ Brilliant 21 cm TFT colour display
- ◆ Split-screen display with independent settings and up to 3 traces per screen
- ◆ Interfaces: GPIB, Centronics, RS-232-C, LAN (option)



Contents Overview

Chapter Overview

Type Index

R&amp;S Addresses



## Test Receiver R&S®ESPI

### Characteristics

The precompliance measuring instruments from Rohde&Schwarz provide the functions that are required for in-house test sequences:

- ◆ Manual measurement of EMI spectra thanks to the receiver-oriented operating concept
- ◆ Semi-automatic measurements with predefined scan and sweep tables allowing interactive interruption
- ◆ Individual evaluation of critical frequencies using markers and additional detectors assigned to the markers which are simultaneously displayed
- ◆ Fully automatic interference measurements in conjunction with external EMI software packages from Rohde&Schwarz, including, for instance, determination of the worst case by automatic switchover of the phase and protective ground settings via the USER port for remote-controlled line impedance stabilization networks

Accuracy and reproducibility are also key parameters for all applications of the R&S®ESPI test receiver family.

The combination of test receiver and spectrum analyzer provides an optimum concept for precompliance measurements in development environments.

### EMI measurements to standard

Fitted with the optional preselector/preamplifier (R&S®ESPI-B2), all R&S®ESPI models feature an excellent dynamic range compared with other precompliance solutions and are, therefore, able to perform precise interference measurements with pulse repetition frequencies (PRF) from **10 Hz** to CISPR 16-1.

Measurements to commercial EMI standards such as CISPR, EN 550xx, ETS, FCC, ANSI C63.4, VCCI or VDE can be carried out directly by comparing the EMI spectrum with the associated limit lines and switching on the appropriate detectors (PK, QP, AV, RMS).

### Options

#### Preamplifier and preselection filters up to 3 GHz

The preselector/preamplifier option (R&S®ESPI-B2) is available as a protection against overloading by pulsed, high-power signals and for ensuring the validity of signal evaluation in the linear operating range of the measuring instrument. In the spectrum analyzer mode and in the test receiver mode, both modes offer the choice of switching the preamplifier on or off. In the receiver mode, the preselection filter setting is fixed, whereas in the analyzer mode it can be selected.

#### Tracking generator 9 kHz to 3 GHz

The optional Internal Tracking Generator R&S®FSP-B9 up to 3 GHz and External Generator Control R&S®FSP-B10 enhance the two R&S®ESPI test receiver models to give scalar network analyzer functionality. A frequency offset of  $\pm 150$  MHz can be set for measurements on frequency-converting modules. The tracking generator can be broadband-modulated by an external I/Q baseband signal.

#### LAN interface

With the aid of the optional LAN Interface R&S®FSP-B16, the R&S®ESPI models can be connected to common networks such as 100Base-T so that functions like file logging on network drives or documentation of measurement results via network

printer are available. The R&S®ESPI can also be remote-controlled via the LAN interface. Control is via a softpanel that behaves exactly as if it were part of a real instrument.

#### Trigger for coverage measurements

The Firmware Option R&S®ESPI-K50 enhances the application range of the Test Receivers R&S®ESPI3 and R&S®ESPI7 by adding field-strength profile measurements controlled by a displacement sensor. For these measurements, the option provides additional channel filters with bandwidths from 5.6 MHz to 8 MHz for DVB-T signals.

The option allows continuous level measurements to be performed with sufficiently high measurement rate and the results to be transferred to an evaluation unit. The measured levels are usually processed by the controller that remotely controls the Test Receiver R&S®ESPI via IEC/IEEE bus or LAN interface.

When a displacement sensor/GPS system is used, the external trigger input of the R&S®ESPI can be used to start single measurements. The level values can thus be accurately assigned to the measurement site.

The coverage measurement function of the R&S®ESPI is only available in the receiver mode plus remote control. There is a choice of two different measurement modes:

- ◆ All measurements are performed at a discrete frequency (>100 000 measurements/s including transfer via IEC/IEEE bus or LAN)
- ◆ A channel list is cyclically processed, i.e. a new frequency is set for each measurement (max. 10 000 channels)



Contents Overview

Chapter Overview

Type Index

R&amp;S Addresses





Contents Overview

Chapter Overview

Type Index

R&amp;S Addresses



## Test Receiver R&amp;S®ESPI

## Specifications in brief

You will find detailed and binding data on the enclosed CD (./DATASHEET/ESPI.pdf), or, for the latest updates, visit [www.rohde-schwarz.com](http://www.rohde-schwarz.com), search term: ESPI

Frequency	R&S®ESPI3	R&S®ESPI7
Frequency range	9 kHz to 3 GHz	9 kHz to 7 GHz
Frequency resolution	0.01 Hz	
Frequency display (receiver mode)		
Display	numerical display	
Resolution	0.1 Hz	
Frequency display (analyzer mode)		
Display	with marker or frequency counter	
Resolution	span/500	
Frequency counter		
Resolution	0.1 Hz to 10 kHz (selectable)	
<b>Spectral purity (dBc (1 Hz))</b> SSB phase noise, f = 500 MHz, carrier offset 10 MHz	-145 dBc (1 Hz) typ.	
Residual FM, f = 500 MHz, RBW 1 kHz, sweep time 100 ms	3 Hz typ.	
<b>Frequency scan (receiver mode)</b>		
Scan	scan with max. 10 subranges with different settings	
Measurement time per frequency	100 µs to 100 s, selectable	
<b>Sweep (analyzer mode)</b>		
Span 0 Hz (zero span)	1 µs to 16000 s	
Span ≥10 Hz	2.5 ms to 16000 s	
<b>IF bandwidths (receiver and analyzer mode)</b>		
Bandwidths (-3 dB)	10 Hz to 10 MHz; in 1, 3, 10 sequence	
EMI bandwidths (CISPR)	200 Hz, 9 kHz, 120 kHz (-6 dB) 1 MHz (pulse bandwidth)	
Video bandwidths (only analyzer mode)	1 Hz to 10 MHz; in 1, 3, 10 sequence	
<b>FFT filter</b>		
Bandwidths (-3 dB)	1 Hz to 30 kHz (-3 dB); in 1, 3, 10 sequence	
<b>Level</b>		
Maximum input level		
DC voltage	50 V	
RF attenuation 0 dB		
CW RF power	127 dBµV (= 0.3 W)	
Pulse spectral density	97 dB(µV/MHz)	
RF attenuation ≥10 dB		
CW RF power	137 dBµV (= 1 W)	
Max. pulse voltage	150 V	
Max. pulse energy (10 µs)	1 mWs	
<b>1 dB compression of input mixer</b> (0 dB RF attenuation, f >200 MHz, without preselector)	0 dBm nominal	
<b>Intermodulation</b>		
3rd-order intermodulation (TOI)		
Intermodulation-free dynamic range, level 2 x -30 dBm, Δf >5 x RBW or 10 kHz, whichever the greater value		
20 MHz to 200 MHz	>70 dBc, TOI >5 dBm	
200 MHz to 3 GHz	>74 dBc, TOI >7 dBm (10 dBm typ.)	
3 GHz to 7 GHz	- >80 dBc, TOI >10 dBm (15 dBm typ.)	

Frequency	R&S®ESPI3	R&S®ESPI7
<b>Second harmonic intercept point (SHI)</b>		
<100 MHz	typ. 25 dBm	
100 MHz to 3 GHz	typ. 35 dBm	
3 GHz to 7 GHz	-	typ. 45 dBm
<b>Displayed average noise level</b>		
0 dB RF attenuation, RBW = 10 Hz, VBW = 1 Hz, 20 averages, trace average, zero span, 50 Ω termination		
10 MHz to 1 GHz	<-142 dBm, typ. -145 dBm	<-140 dBm, typ. -145 dBm
<b>Immunity to interference</b>		
Image rejection	>70 dB	
Intermediate frequency (f <3 GHz)	>70 dB	
Spurious responses (f >1 MHz, without input signal, 0 dB attenuation)	<-103 dBm	
<b>Level display (receiver mode)</b>		
Digital	numerical; 0.01 dB resolution	
Analog	bargraph display, separately for each detector	
Spectrum	level axis 10 dB to 200 dB in 10 dB steps, frequency axis user- selectable, linear or logarithmic	
Detectors	average (AV), RMS, MaxPeak, MinPeak and Quasi-Peak (QP), 3 detectors can be switched on simultaneously	
Measurement time	100 µs to 100 s, selectable	
<b>Level display (analyzer mode)</b>		
Result display	501 x 400 pixels (one diagram), max. 2 diagrams with independent settings	
Log level scale	10 dB to 200 dB in 10 dB steps	
Linear level scale	10% of reference level per level division (10 divisions)	
Traces	max. 3 per diagram	
Trace detectors	MaxPeak, MinPeak, AutoPeak, Sample, RMS, Average, Quasi-Peak	
Trace functions	Clear/Write, MaxHold, MinHold, Average	
<b>Setting range of reference level</b>		
Logarithmic level display	-130 dBm to +30 dBm, in 0.1 dB steps	
<b>Level measurement accuracy</b>		
Level accuracy at 128 MHz (level = -30 dBm, RF attenuation 10 dB, ref. level -20 dBm, RBW 10 kHz)	<0.2 dB (σ = 0.07 dB)	
Quasi-peak display	in line with CISPR 16-1, ≥10 Hz pulse repetition frequency (with option R&S®ESPI-B2)	
<b>Frequency response</b>		
50 kHz to 3 GHz	<0.5 dB (σ = 0.17 dB)	
Attenuator	<0.2 dB (σ = 0.07 dB)	
Reference level switching	<0.2 dB (σ = 0.07 dB)	
<b>Total measurement uncertainty (0 Hz to 3 GHz)</b>		
Spectrum analyzer mode without preselection	0.5 dB	
Receiver mode with preselection	<1.5 dB	
<b>Audio demodulation</b>	AM and FM	
Audio output	loudspeaker and headphones output	



Contents Overview

Chapter Overview

Type Index

R&amp;S Addresses







Contents Overview

Chapter Overview

Type Index

R&amp;S Addresses



## Test Receiver R&amp;S®ESPI

Frequency	R&S®ESPI3	R&S®ESPI7
<b>Trigger functions</b>		
Trigger source	free run, video, external, IF level	
Trigger offset	125 ns to 100 s, resolution	
<b>Gated sweep</b>		
Trigger source	external, IF level, video	
Gate delay	1 µs to 100 s	
Gate length	125 ns to 100 s	
<b>Interfaces</b>		
IEEE-bus remote control	IEEE488.2 (IEC625)	
Serial interface	RS-232-C, 9-pin SUB-D connector	
Printer interface	parallel interface (Centronics)	

## General data

Display	21 cm TFT colour display (8.4") (VGA)	
Rated temperature range	+5°C to +40°C	
AC power supply	100 V AC to 240 V AC, 50 Hz to 400 Hz	
Power consumption	70 VA	120 VA
Dimension (W × H × D)	412 mm × 197 mm × 417 mm	
Weight	10.5 kg	11.3 kg

## Ordering information

<b>Test Receiver</b>		
9 kHz to 3 GHz	R&S®ESPI 3	1142.8007.03
9 kHz to 7 GHz	R&S®ESPI 7	1142.8007.07
<b>Accessories supplied</b>	Power cable, operating manual, service manual, adaptor cable for probe power	
<b>Options</b>		
Preselector/Preamplifier (factory-fitted)	R&S®ESPI-B2	1129.7498.02
Extended environment spec (1.9 g rms, 0 to 55 deg. G) for R&S®ESPI	R&S®ESPI-B20	1155.1606.03
Rugged case, carrying handle (factory-fitted)	R&S®FSP-B1	1129.7998.02
OCXO Reference Frequency	R&S®FSP-B4	1129.6740.02
TV Trigger and Adjustable RF Power Trigger (40 dB) for R&S®FSP and R&S®ESPI	R&S®FSP-B6	1129.8594.02
Internal Tracking Generator		
9 kHz to 3 GHz, I/Q modulator	R&S®FSP-B9	1129.6991.02
External Generator Control	R&S®FSP-B10	1129.7246.02
LAN Interface 100BT	R&S®FSP-B16	1129.8042.02
DC Supply 12 V to 28 V	R&S®FSP-B30	1155.1158.02

Battery Pack + Charge Unit <sup>1)</sup>	R&S®FSP-B31	1155.1258.02
Replace Battery Pack	R&S®FSP-B32	1155.1506.02
<b>Software</b>		
Firmware Coverage Measurements	R&S®ESPIK50	
Noise Measurement Software	R&S®FS-K3	1057.3028.02
<b>Extras</b>		
Pulse Limiter 0 Hz to 30 MHz	R&S®ESH3-Z2	0357.8810.54
Control Cable V-Network R&S®ESH2-Z5	R&S®EZ-13	1026.5293.02
Control Cable V-Network R&S®ESH3-Z5 (2 m)	R&S®EZ-14	1026.5341.02
Control Cable V-Network R&S®ENV216 (3 m)	R&S®EZ-1	1107.2087.03
Headphones	–	0708.9010.00
US Keyboard with trackball	R&S®PSP-Z2	1091.4100.02
PS/2 Mouse	R&S®FSE-Z2	1084.7043.02
IEC/IEEE-Bus Cable, 1 m or 2 m	R&S®PCK	0292.2013.x0
19" Rack Adapter (not for R&S®FSP-B1)	R&S®ZZA478	1096.3248.00
Bag for Instruments	R&S®ZT-473	1109.5048.00
Matching Pad, 75 Ω, L Section Series Resistor, 25 Ω <sup>2)</sup>		
SWR Bridge, 5 MHz to 3000 MHz	R&S®RAM R&S®RAZ R&S®ZRB2	0358.5414.02 0358.5714.02 0373.9017.52
High-Power Attenuators, 100 W 3/6/10/20/30 dB	R&S®RBU 100 (XX = 03/06/10/20/30)	1073.8820.XX
High-Power Attenuators, 50 W 3/6/10/20/30 dB	R&S®RBU 50 (XX = 03/06/10/20/30)	1073.8695.XX

1) Requires R&S®ESPI with option R&S®FSP-B1.

2) Taken into account in device function RF INPUT 75 Ω.

## See also data sheets

Accessories for Test Receivers and Spectrum Analyzers: PD 0756.4320  
EMC Test Antennas: PD 0757.5743



Contents Overview

Chapter Overview

Type Index

R&amp;S Addresses





Contents Overview

Chapter Overview

Type Index

R&amp;S Addresses



## EMI Test Receiver R&amp;S® ESCI

New

**Compact EMI test receiver for compliance tests to all civil standards from 9 kHz to 3 GHz**

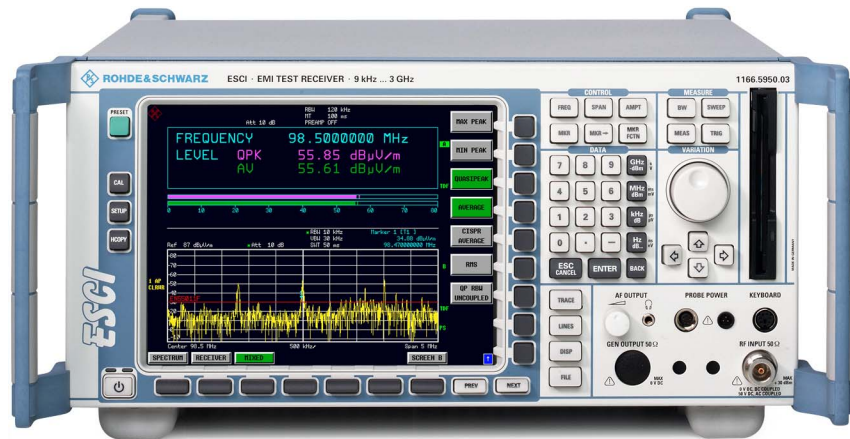

## Brief description

With the EMI Test Receiver R&S® ESCI, a top-class instrument is added to the family of EMI test receivers with spectrum analyzer platform. The R&S® ESCI provides measurements in full compliance with CISPR 16-1-1. The instrument operates in the frequency range from 9 kHz to 3 GHz and is equipped with a 21 cm TFT colour display. The EMI Test Receiver R&S® ESCI measures electromagnetic emissions in line with all civil standards and combines several types of instrument in one:

- ◆ Portable, tunable EMI test receiver that can be operated independently of the AC supply with the R&S® FSP-B30 and R&S® FSP-B31 battery options fitted and, with a weight of only 10.5 kg, is ideal for mobile use
- ◆ Spectrum analyzer with excellent RF characteristics and ample measurement functions for laboratory measurements, as well as measurements in compliance with mobile radio standards, featuring an RMS detector, selectable ACP standard and channel bandwidths up to 5 MHz

- ◆ Automatic, standard-conforming test receiver that independently performs measurements for certifications
- ◆ System-compatible test receiver capable of remote control via IEC/IEEE-bus interface, or LAN interface in conjunction with EMI software packages, e.g. R&S® EMC32
- ◆ Time-domain analyzer for measuring click interference, capable of recording interference versus time for a period of over two hours

## Main features

## Excellent test receiver characteristics

- ◆ For all commercial EMI requirements such as CISPR, EN, ETS, FCC, ANSI C63.4, VCCI and VDE
- ◆ Peak (max, min), quasi-peak, RMS, CISPR average, average detectors (max. three detectors can be switched on simultaneously)
- ◆ Bargraph display for various detectors, with peak-hold indication
- ◆ Pulse weighting conforming to CISPR 16-1-1 with quasi-peak detector
- ◆ Time-domain analysis, e.g. for measuring click interference
- ◆ CISPR-conformant EMI measurement bandwidths:  
200 Hz, 9 kHz, 120 kHz, 1 MHz

- ◆ 11 preselection filters and built-in 20 dB preamplifier
- ◆ Pulse-protected RF input
- ◆ Power supply for accessories such as sensors, probes and antennas
- ◆ Overload indication
- ◆ Built-in AF demodulator
- ◆ Bright 21 cm TFT colour display

## Powerful firmware functions

- ◆ Scan table with independently programmable parameters for up to ten subranges for automatic and interactive test routines
- ◆ Prescan measurement, data reduction and final measurement separately for each trace memory
- ◆ Correction values for cable loss, coupling networks and antennas taken into account in the form of transducer factors
- ◆ Data reduction and modification of frequency list for weighted final measurement
- ◆ Limit lines in accordance with civil standards
- ◆ Automatic level calibration
- ◆ Storage of complete instrument setups on disk or internal hard disk



Contents Overview

Chapter Overview

Type Index

R&amp;S Addresses





Contents Overview

Chapter Overview

Type Index

R&amp;S Addresses



## EMI Test Receiver R&S®ESCI

### High measurement speed

- ◆ Receiver mode
  - Measurement times from 100 s (SCAN mode)
- ◆ Spectrum mode
  - Sweep times from 2.5 ms to 16000 s (span >10 Hz)
  - Zero span (time domain) from 1 s to 16000 s, resolution 125 ns

### Spectrum analyzer

- ◆ Overview measurements in spectrum analyzer mode
- ◆ Resolution bandwidths from 10 Hz to 10 MHz (in steps of 1/3/10)
- ◆ RMS detector for measurements on digitally modulated signals
- ◆ Digital filters from 1 Hz to 30 kHz
- ◆ Channel filter bandwidths from 100 Hz to 5 MHz
- ◆ Test routines for IP3, ACPR, OBW
- ◆ Fast ACP measurements in time domain

### Performance

- ◆ 1 dB compression >+5 dBm (without preselection)
- ◆ Total measurement uncertainty
  - Receiver mode <1 dB
  - Spectrum analyzer mode <0.5 dB (without preselection)
- ◆ Displayed average noise level (DANL) typ. -155 dBm (RBW = 10 Hz, preamplifier switched on)
- ◆ Phase noise (f = 500 MHz) <-113 dBc (1 Hz) (at 10 kHz from carrier)

### Other features

#### A new dimension in measurement speed and accuracy

The R&S®ESCI sets new standards in terms of scope of functions, measurement speed and measurement accuracy in the instrument class up to 3 GHz.

The use of innovative techniques such as an LSI frontend and largely digital signal processing, in conjunction with Rohde & Schwarz-developed ASICs, result in excellent specifications and high reliability.

The measurements required for verifying compliance with electromagnetic compatibility requirements are laid down in international and national legislation and standards. The measurements stipulated for conducted and radiated EMI until approval and CE certification are extremely time-consuming. The R&S®ESCI's built-in intelligence substantially reduces the measurement effort and thus significantly cuts down on measurement time.

This specialist for EMI measurements furnishes results at maximum speed and accuracy in accordance with the requirements published by CISPR, CENELEC, ETSI, FCC, VCCI and VDE.

EMI full-compliance test receivers are needed when certification in accordance with relevant standards is to be obtained. Featuring a pulse-resistant attenuator, preselection with a 20 dB preamplifier and a frontend withstanding high loads, the EMI Test Receiver R&S®ESCI fully satisfies the requirements for measurements in line with the CISPR, VDE, ANSI, FCC, EN and VCCI standards.

#### Fast EMI measurements and MIXED mode display

The typical EMC parameters such as

- RFI voltage,
- RFI power and
- RFI field strength

can be measured both with the analyzer and the test receiver.

The analyzer comes into its own where fast prescan sweeps have to be performed and evaluated with marker functions. The test receiver, on the other hand, offers the more elaborate tech-

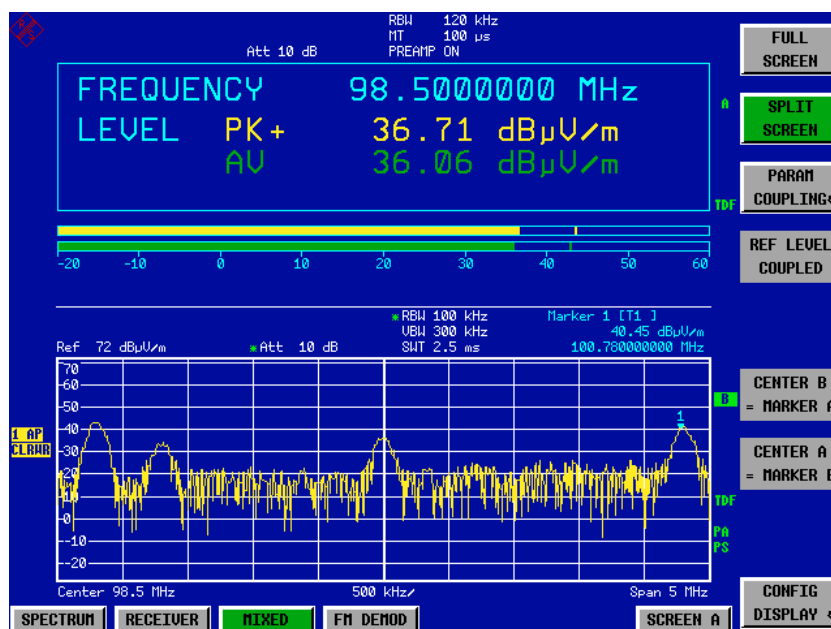

*MIXED mode bargraph measurement and spectrum. The standard-conforming bargraph measurement and the fast sweep are displayed simultaneously*



Contents Overview

Chapter Overview

Type Index

R&amp;S Addresses



## EMI Test Receiver R&S® ESCI

niques with respect to data reduction and standard-conforming final measurements including storage of all measured values and exact frequency measurement.

A large number of operating parameters can be coupled or decoupled both for the test receiver and the spectrum analyzer mode.

### Ready for the PC world ...

- ◆ PC-compatible screenshots without any need for conversion software
- ◆ Windows printer support
- ◆ USB interface (keyboard, mouse)
- ◆ Drivers: LabView, LabWindows/CVI, VXI plug & play instrument driver for VEE, Visual Basic, Visual C++, Borland C++, etc
- ◆ SCPI-compatible

### Options

#### Sturdy construction – for use under any conditions

For outdoor applications, the R&S® ESCI is available with an enclosure (option R&S® FSP B1) with shock-absorbing corners and carrying handles. In vehicles, the test receiver can be operated from an

optional 12 V to 28 V DC power supply (R&S® FSP-B30). On open-area test sites, the R&S® ESCI can perform measurements for several hours if equipped with the optional R&S® FSP-B31 battery pack. In extreme cases, an additional battery pack can be used. In the R&S® ESCI standard unit, data is stored on a hard disk. For use in vehicles, a flash disk can be used instead of the hard disk to accommodate for major temperature fluctuations (0°C to 55°C) and aggravated shock and vibration. The flash disk option (R&S® ESCI B20) has been specially designed for use under adverse conditions.

#### FM Measurement Demodulator R&S® FS K7

The R&S® FS K7 adds universal digital FM demodulation capability to the R&S® ESCI.

#### LAN Interface R&S® FSP-B16

Using the optional LAN Interface R&S® FSP B16, the R&S® ESCI can be configured as a network workstation. The Windows XP Remote Desktop function makes it particularly easy to log files on network drives or to document results via a network printer. This yields a clear speed advantage over the IEC/IEEE bus,

especially for the transmission of large data blocks. This makes the R&S® ESCI ideal for networking.

#### Internal Tracking Generator R&S® FSP-B9

The Internal Tracking Generator R&S® FSP-B9 covers the frequency range from 9 kHz to 3 GHz. A frequency offset of ±150 MHz can be set for measurements on frequency-converting modules. The tracking generator can be broadband-modulated using an external I/Q base-band signal.

#### External Generator Control R&S® FSP-B10

The R&S® FSP-B10 option uses a commercial RF signal generator as its external tracking source that can be controlled via the GPIB or a TTL bus. This option provides the functionality of the internal tracking generator.

#### TV Trigger and RF Power Trigger R&S® FSP-B6

The R&S® FSP-B6 option makes the test receiver suitable for analog TV measurements. It provides a settable RF level trigger for measurements on pulsed RF signals that are used in TDMA transmission systems.

### Specifications in brief

You will find detailed and binding data on our homepage [www.rohde-schwarz.com](http://www.rohde-schwarz.com), search term: ESCI

#### Frequency

Frequency range	9 kHz to 3 GHz
Frequency resolution	0.01 Hz
Frequency display (receiver mode)	numeric display
Frequency display (analyzer mode)	with marker or frequency counter
Spectral purity, SSB phase noise f = 500 MHz, carrier offset = 10 MHz	typ. -145 dBc (1 Hz)

Scan	max. 10 partial ranges with different settings
Measurement time per frequency	100 µs to 100 s
<b>Sweep (analyzer mode)</b>	
In time range, span = 0 Hz	1 µs to 16000 s, resolution 125 ns
In frequency range, span ≥ 10 Hz	2.5 ms to 16000 s
<b>Resolution bandwidth</b>	
Sweep filter	
3-dB bandwidths	10 Hz to 3 MHz in 1/3 sequences
EMI filters (-6 dB, pulse bandwidth)	200 Hz, 9 kHz, 120 kHz, 1 MHz
Video bandwidths (analyzer mode)	1 Hz to 10 MHz in 1/3 sequences
FFT filters (-3 dB, analyzer mode)	1 Hz to 30 kHz in 1/3 sequences



Contents Overview

Chapter Overview

Type Index

R&amp;S Addresses



## EMI Test Receiver R&amp;S® ESCI

Channel filters (bandwidths) 100/200/300/500 Hz, 1/1.5/2/2.4/2.7/3/3.4/4/4.5/5/6/8.5/9/10/12.5/14/15/16/18 (RRC)/20/21/ 24.3 (RRC)/25/30/50/100/150/192/200/300/500 kHz, 1/1.228/1.28 (RRC)/1.5/2/3/3.84 (RRC)/4.096 (RRC)/5 MHz (RRC = Root Raised Cosine)	
Preselection (can be switched off in analyzer mode)	11 preselection filters
Preamplifier (switchable between preselection and 1st mixer)	20 dB

## Level

<b>Display range</b>	displayed noise floor to 30 dBm
<b>Max. input level</b>	
RF attenuation $\geq 10$ dB	
DC voltage	0 V (DC coupling); 50 V (AC coupling)
CW RF power	30 dBm
Max. pulse volt age (10 $\mu$ s)	150 V
Max. pulse energy (20 $\mu$ s)	10 mWs
RF attenuation $\geq 10$ dB	
Pulse spectral density	97 dB $\mu$ V/MHz
<b>Intermodulation</b>	
1 dB compression of input mixer (f > 200 MHz, 0 dB RF attenuation, pre- selection and preamplifier OFF)	5 dBm (nominal)
3rd-order intercept point (T.O.I., 200 MHz to 3 GHz, level 2 $\times$ -30 dBm, $\Delta f > 5 \times$ IF bandwidth or resolution bandwidth, or $> 10$ kHz)	
Without preselection	$> 7$ dBm, typ. 10 dBm
With preselection, without preamp.	$> 2$ dBm, typ. 5 dBm
With preselection and preamplifier	$> 18$ dBm, typ. -15 dBm
Intercept point k2 (100 MHz to 3 GHz)	
Without preselection	typ. 35 dBm
With preselection, without preamp.	$> 50$ dBm
With preselection and preamplifier	$> 35$ dBm
<b>Displayed noise floor (analyzer mode)</b>	
0 dB RF attenuation, RBW = 10 Hz, VBW = 1 Hz, span = 0 Hz, 20 averages, trace average, 50 $\Omega$ termination, 10 MHz to 1 GHz	
Without preselection (AC/DC coupl.)	$< -142$ dBm, typ. -145 dBm
With preselection, without preamp.	$< -142$ dBm, typ. -145 dBm
With preselection and preamplifier	$< -152$ dBm, typ. -155 dBm
<b>Displayed noise floor (receiver mode)</b>	
AV display, 30 MHz to 1 GHz, BW = 120 kHz	
Without preamplifier	$< 6$ dB $\mu$ V, typ. 3 dB $\mu$ V
With preamplifier	$< -16$ dB $\mu$ V, typ. -19 dB $\mu$ V
<b>Immunity to interference</b>	
Image frequency, IF	$> 70$ dB
Spurious response (f > 1 MHz, without input signal, 0 dB RF attenuation)	$< -103$ dBm
Other spurious	$< -70$ dBc
<b>RF leakage</b>	
Level display, field strength 3 V/m, 0 dB RF attenuation, 50 $\Omega$ term., f $\neq$ f <sub>IF</sub>	$< 10$ dB $\mu$ V (nominal)
Level display (receiver mode)	
Level display, digital	numeric, 0.01 dB resolution
Level display, analog	bargraph display, separate for each detector
Spectrum, level axis	level axis 10 dB to 200 dB in 10 dB steps
Spectrum, frequency axis	user-selectable, linear or logarithmic

<b>Level display (analyzer mode)</b>	
Result display	501 x 400 pixels (per diagram), max. 2 diagrams with independent settings
Logarithmic level display range	1 dB, 10 dB to 200 dB in 10 dB steps
Linear level display range	10% of reference level per division (10 divisions)
Traces, 1 diagram	3
Traces, 2 diagrams	6
<b>Level measurement accuracy</b>	
Total error	
Without preselection and preampl.	0.5 dB
With preselection and preamplifier	1 dB
Quasi peak display	according to CISPR 16-1

## Trigger functions

Trigger source	free run, video external, IF level
Trigger offset, span $\geq 10$ Hz	125 ns to 100 s
Gate source	video external, IF level
Gate delay	1 $\mu$ s to 100 s

## Interfaces

External noise sources supply	BNC, female, 28 V DC
IEC/IEEE-bus remote control	IEC 625-2/IEEE 488.2
Serial interface	RS-232-C
Printer interface	Centronics parallel
USB interface	Version 1.1

## General data

Display	21-cm TFT color display, VGA
Operating temperature range	+5°C to +40°C 0°C to +50°C (with option R&S® ESCI-B20)
Power supply	100 V AC to 240 V AC, 50 Hz to 400 Hz, 3.1 to 1.3 A, 70 VA
Dimensions (W x H x D)	412 mm x 197 mm x 417 mm
Weight	10.5 kg

## Ordering information

<b>EMI Test Receiver</b>	R&S® ESCI	1166.5950.03
Accessories supplied	Power cord, operating manual, service manual	
<b>Options</b>		
Rugged Case with Variable Carrying Handle	R&S® FSP-B1	1129.7998.02
OCXO 10 MHz	R&S® FSP-B4	1129.6740.02
TV Trigger/RF Power Trigger	R&S® FSP-B6	1129.8594.02
Tracking Generator, I/Q Modulator	R&S® FSP-B9	1129.6991.02
External Generator Control	R&S® FSP-B10	1129.7246.02
LAN Interface 100 BT	R&S® FSP-B16	1129.8042.03
Extension of Environmental Specifications	R&S® ESCI-B20	1155.1606.09
DC Power Supply	R&S® FSP-B30	1155.1158.02
NIMH Battery Pack + Charger	R&S® FSP-B31	1155.1258.02
Spare Battery Pack (NIMH)	R&S® FSP-B32	1155.1506.02



Contents Overview

Chapter Overview

Type Index

R&amp;S Addresses



## EMI Test Receiver R&amp;S® ESIB

R&S® ESIB7: 20 Hz to 7 GHz

R&S® ESIB26: 20 Hz to 26.5 GHz

R&S® ESIB40: 20 Hz to 40 GHz

EMI measurements up to 40 GHz

conforming to standards

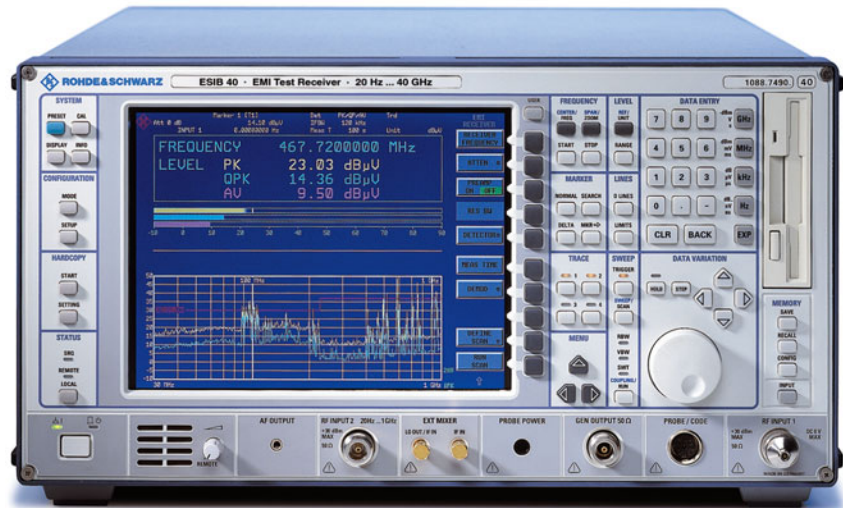

R&S® ESIB 40

### Brief description

The EMI test receivers of the R&S® ESIB family combine the versatility and measurement speed of spectrum analyzers with the advantages of classic test receivers and fulfill the extremely high dynamic requirements for EMI measurements in conformance with standards.

The R&S® ESIB family comprises three models with different upper frequency limits. The upper frequency limit of the R&S® ESIB26 and R&S® ESIB40 can be extended up to 110 GHz by means of external mixers (option R&S® FSE-B21).

### Main features

#### State-of-the-art technology

- ◆ Low inherent noise
- ◆ Wide dynamic range
- ◆ Preselection + preamplifier
- ◆ Automatic overload control
- ◆ Pulse-protected 2nd RF input
- ◆ Fast overview measurements

#### Current standards

- ◆ Correct weighting of pulses to CISPR 16-1-1 and VDE0876

- ◆ All commercial and military standards such as CISPR, EN, ETS, FCC, VDE, ANSI, VCCI, MIL-STD, VG, DEF-STAN, and many others

#### Straightforward operation

- ◆ Active colour LCD
- ◆ Analog level display for each detector (parallel operation)
- ◆ Split-screen display for detailed analysis (i. e. combination of Analyzer and receiver settings)
- ◆ Receiver-oriented operating concept allowing manual operation
- ◆ EMI software package R&S® ES-K1 supplied

#### System integration

- ◆ Fast data processing for use in automatic test systems. The IEC/IEEE bus command set (IEC 625-2) is SCPI-conformal (1994.0)
- ◆ Integrated computer function under Windows provided as standard
- ◆ Use as test system controller by adding a second IEC/IEEE bus card (option R&S® FSE-B17)
- ◆ Space- and cost-saving implementation of complete test systems without need for an additional controller

#### Documentation of results

- ◆ All printers for which Windows drivers are available can be used
- ◆ Storage of results also on floppy disk or built-in hard disk in standard formats such as EMF, WMF or BMP

### Description

#### Practice-oriented test routines

During the various development phases of a product, different measurements are performed as required for each stage. The R&S® ESIB family offers appropriate features and routines for the different development stages. Early in development, functional measurements play the predominant role. While EMI measurements are important right from the beginning to avoid redesigns, the R&S® ESIB at this stage primarily functions as a high-grade spectrum analyzer (see R&S® FSE, page 185).

As development progresses, EMI measurements become more and more important, for example on modules and their interfaces. Here, too, the R&S® ESIB family meets all relevant requirements in terms of performance, functionality and economy of operation:



Contents Overview

Chapter Overview

Type Index

R&amp;S Addresses



## EMI Test Receiver R&amp;S® ESIB

- ◆ Fast overview measurements with linear or logarithmic frequency scale in spectrum analyzer mode (sweep mode) or in test receiver mode (scan mode) with tuning in user-defined frequency steps with selectable measuring times per step
- ◆ Bandwidths conforming to CISPR 16-1-1 (200 Hz, 9 kHz and 120 kHz), to MIL-STD (10 Hz to 1 MHz) and 10 MHz, and analyzer bandwidths between 1 Hz and 10 MHz, selectable in steps of 1, 2, 3 and 5
- ◆ Pulse weighting using quasi-peak, peak and average detectors. Max. 4 detectors operate in parallel and can be switched in as required
- ◆ User-selectable transducer factors for the output of results in the correct unit. Transducer factors for practically any number of transducers can be stored on the internal hard disk
- ◆ User-definable limit lines with linear or logarithmic frequency scale; limit lines are stored on the internal hard disk
- ◆ Preselection, preamplifier and 6-dB EMI bandwidths selectable in analyzer mode, too
- ◆ Time-domain measurements at up to 50 ns resolution for interference source analysis
- ◆ Automatic scan: From 1 measuring curve with max. 250 000 measuring values up to 4 storable traces with max. 80 000 measured values each
- ◆ Second, pulse-protected input for the frequency range 20 Hz to 1 GHz. In the case of the R&S® ESIB 7, i.e., this input can handle pulses with voltages up to 1500 V and powers up to 30 mW without any damage being caused
- ◆ Preselection with 3 fixed-tuned and 6 or 7 (models .26 and .40) tracking filters: in receiver mode (fixed) and analyzer mode (selectable)

- ◆ 20 dB preamplifier switch-selectable at switched-on preselection (standard 1 kHz to 7 GHz, expandable to 26 GHz or 40 GHz with option R&S® ESIB-B2)
- ◆ Level measurement accuracy  $< \pm 1$  dB in frequency range up to 1 GHz

**Definition of standard test sequences**

To meet the requirements of relevant standards, measurements over various frequency ranges and bandwidths have to be performed, using different step sizes and measurement times or different receiver settings regarding RF attenuation and preamplification. It must also be possible to configure a scan matched to DUT characteristics. For this purpose, the R&S® ESIB offers a user-configurable scan table with up to 10 subranges.

Calibration values for transducer factors of absorbing clamps or antennas, for example, are stored in tables and can be switched on as required. The transducer factors can also be combined into transducer sets, for example to display the interference spectrum in the correct unit dB $\mu$ V/m in measurements with an antenna and a connecting cable.

EMI emissions are usually measured in two steps. An overview measurement made with the peak detector identifies critical emissions above or close to limit values. In a second measurement with the prescribed detectors (quasi-peak and average to CISPR 16-1-1) and an appropriate

measurement time, the critical frequencies are checked for compliance with limit values. The R&S® ESIB family supports this procedure by two independent measurement windows on the screen, automatic or interactive investigation of frequencies that have the highest distortion levels as well as application of a partly range maximum method (acceptance analysis).

**Fit for the future**

The R&S® ESIB family can be upgraded by a wide variety of options to extend its range of applications and add extra functionality without requiring additional instruments.

**Selftest**

The built-in selftest supports fault localization down to module level. With individual correction tables being stored on each module, defective modules can be replaced largely without any adjustment or additional instruments. Downtimes and repair costs are reduced to a minimum.

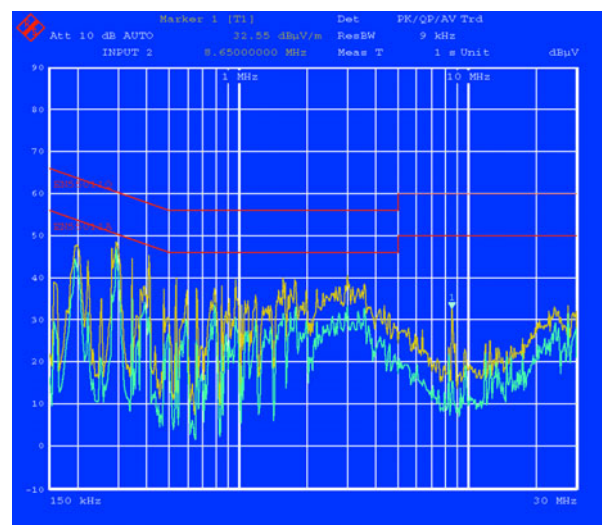

*An overview measurement made with the peak detector identifies critical emissions above or close to limit values. In a second measurement with the prescribed detectors (quasi-peak and average to CISPR) and an appropriate measurement time, the critical frequencies are checked for compliance with limit values*



Contents Overview

Chapter Overview

Type Index

R&amp;S Addresses



## EMI Test Receiver R&S® ESIB

### Specifications in brief

You will find detailed and binding data on the enclosed CD (./DATASHEET/ESIB.pdf), or, for the latest updates, visit [www.rohde-schwarz.com](http://www.rohde-schwarz.com), search term: ESIB

	R&S® ESIB7	ESIB26	ESIB40
<b>Frequency</b>			
<b>Frequency range</b>			
Input 1	20 Hz to 7 GHz	20 Hz to 26.5 GHz	20 Hz to 40 GHz
Input 2	20 Hz to 1 GHz		
Frequency display (receiver mode)	numeric display		
Frequency display (analyzer mode)	with marker		
Frequency counter	measures the marker frequency		
<b>Spectral purity</b>			
SSB phase noise, f ≤ 500 MHz, span > 100 kHz, carrier offset 100 kHz	< -111 dBc (1 Hz)		
<b>Frequency scan (receiver mode)</b>	scan with max. 10 subranges with different settings		
Measurement time per frequency	100 μs to 1000 s, selectable		
<b>Sweep (analyzer mode)</b>			
Span 0 Hz (zero span)	1 μs to 16000 s selectable in steps of 5%		
Span ≥ 10 Hz	5 ms to 1000 s selectable in steps of ≤ 10%		
Picture refresh rate/s (span ≤ 7 GHz)	> 20 updates/s with 1 trace, > 15 traces/s with 2 traces at shortest sweep time		
Sampling rate	50 ns (20 MHz A/D converter)		
Number of pixels	500		
Time-domain measurement	with marker and cursor lines		
<b>IF bandwidths (receiver mode)</b>			
6 dB bandwidths	10/100/200 Hz, 1/9/10/100/120 kHz, 1 <sup>1</sup> /10 MHz		
<b>Resolution bandwidths (analyzer mode)</b>			
3 dB bandwidth	1 Hz to 10 MHz, in steps of 1/2/3/5		
Video bandwidths	1 Hz to 10 MHz, in steps of 1/2/3/5		
<b>FFT filter</b>			
3 dB bandwidths	1 Hz to 1 kHz, in steps of 1/2/3/5		
<b>Level</b>			
<b>Max. input level (input 1)</b>			
RF attenuation ≥ 10 dB			
DC voltage	0 V		
CW RF power	137 dBμV (= 1 W)		
Max. pulse volt age (10 μs)	150 V	50 V	
Max. pulse energy (10 μs)	1 mWs	0.5 mWs	
Input 2 (receiver mode)	20 Hz to 1 GHz		
DC voltage (DC/AC coupling)	0 V/50 V		
RF attenuation ≥ 10 dB			
CW RF power	137 dBμV (= 1 W)		
Max. pulse voltage (10 μs)	1500 V	250 V	
Max. pulse energy (10 μs)	30 mWs	15 mWs	
<b>1 dB compression of input mixer (0 dB RF attenuation)</b>			
Analyzer mode	+10 dBm nominal		
<b>Intermodulation</b>			
3rd-order intercept point (T.O.I.) in dBm			
Analyzer mode, Δf > 5 × IF bandwidth or resolution bandwidth, or > 10 kHz	≥ 12, typ. 15 for f > 150 MHz	≥ 12, 15 typ. for f > 150 MHz; ≥ 10 for f > 7 GHz	

	R&S® ESIB7	ESIB26	ESIB40
Receiver mode, preamplifier off	typ. ≥ 2, 5 for f > 150 MHz		
Receiver mode, preamplifier on	≥ -18, typ. -15 for f > 150 MHz		
Intercept point k2, analyzer mode	typ. > 25 for f < 150 MHz typ. > 40 for f > 150 MHz		
<b>Level display (receiver mode)</b>			
Digital	numeric, 0.1 dB resolution		
Analog	bargraph display, separate for each detector		
Spectrum	level axis 10 dB to 200 dB in 10 dB steps, frequency axis user-selectable, linear or logarithmic		
Detectors	average (AV), RMS, peak (PK) and quasi-peak (QP), 4 detectors simultaneously selectable		
Measurement time	100 μs to 100 s, selectable		
<b>Level display (analyzer mode)</b>			
Result display	500 × 400 pixels (per diagram), max. 2 diagrams with independent settings		
Logarithmic level display range	10 dB to 200 dB in 10 dB steps		
Linear level display range	10% of reference level per division (10 divisions) or logarithmic scaling		
Traces	max. 4 per diagram (max. 2 per diagram with display of 2 diagrams); quasi-analog display of all results		
Trace detectors	max peak, min peak, auto peak (normal), sample, rms, average		
Trace functions	clear/write, max hold, min hold, average		
<b>Setting range of reference level</b>			
Logarithmic level display	-130 dBm to 30 dBm in 0.1 dB steps		
<b>Displayed noise floor (receiver mode)</b>			
Linear average (AV) display (preamplifier off/on)			
1 GHz to 5 GHz, RBW=1 MHz	< 15/< 6 dB	< 18/< 9 dB	
RMS, typ. increase rel. to AV display	+1 dB		
PK, typ. increase rel. to AV display	+11 dB		
Quasi-peak (preamplifier off/on)	3 to -9/ -7 to -21	3 to -9/-7 to -21	
Band A			
Band B	9 to 0/ -2 to -12	9 to 0/-2 to -12	
Band C	17/1	20/4	
Band D	14/1	17/4	
<b>Displayed noise floor (analyzer mode)</b>			
Displayed average noise level in dBm, typical values in parentheses, 0 dB RF attenuation, RBW = 10 Hz, VBW = 1 Hz, 20 averages, trace average, zero span, 50 Ω termination			
Frequency 10 MHz to 6 GHz	< -142 (147)	< -138 (140)	
<b>Max. dynamic range</b>			
1 dB compression point/displayed noise floor (1 Hz bandwidth)	162 dB	160 dB	
<b>Max. harmonics suppression, f &gt; 50 MHz</b>			
	> 90 dB		
<b>Max. intermodulation-free range</b>			
150 MHz to 7/26.5 GHz (nominal)	115 dB	112 dB	
Intermodulation-free range at -40 dBm mixer input level	105 dB		
<b>Immunity to interference</b>			
Image frequency	> 80 dB, typ. > 90 dB	> 80 dB	
Intermediate frequency	> 75 dB	> 80 dB	
<b>Spurious response (f &gt; 1 MHz, without input signal, 0 dB RF attenuation)</b>			
Receiver mode or span < 30 MHz	< -3 dBμV		
Span ≥ 30 MHz	< 7 dBμV		





Contents Overview

Chapter Overview

Type Index

R&amp;S Addresses



## EMI Test Receiver R&amp;S® ESIB

	R&S® ESIB 7	ESIB 26	ESIB 40
<b>Level measurement accuracy</b>			
Level error at 120 MHz (level = -40 dBm, RF attenuation 20 dB, reference level -15 dBm, RBW 5 kHz)		±0.3 dB	
Attenuator error		±0.3 dB	
<b>Bandwidth switching error</b>			
1 Hz to 30 kHz/100 to 300 kHz		±0.2 dB	
1 MHz to 10 MHz		±0.3 dB	
<b>Frequency response (analyzer mode, 10 dB RF attenuation)</b>			
≤1 GHz		±0.5 dB	
1 GHz to 7 GHz		±1 dB	
7 GHz to 18 GHz	–	±2 dB	
18 GHz to 26.5 GHz	–	±2.5 dB <sup>1)</sup>	
26.5 GHz to 40 GHz	–	–	±3 dB <sup>2)</sup>
<b>Total error</b>			
Receiver mode (AV display, display range =0 dB to -50 dB, S/N >15 dB, preamplifier off)			
≤9 kHz		±1.5 dB	
≤150 kHz		±1.2 dB	
≤1 GHz		±1 dB	
1 GHz to 4.5 GHz		±2 dB	
4.5 GHz to 7 GHz		±2.5 dB	
7 GHz to 18 GHz	–	±2.5 dB <sup>2)</sup>	
18 GHz to 26.5 GHz	–	±3 dB <sup>2)</sup>	
26.5 GHz to 40 GHz	–	–	±3.5 dB <sup>2)</sup>
Analyzer mode (display range = 0 dB to -50 dB, S/N >15 dB, span/RBW <100)			
<1 GHz		±1 dB	
1 GHz to 4.5 GHz		±1.5 dB	
4.5 GHz to 7 GHz		±2 dB	
7 GHz to 18 GHz	–	±2.5 dB <sup>2)</sup>	
18 GHz to 26.5 GHz	–	±3 dB <sup>2)</sup>	
26.5 GHz to 40 GHz	–	–	±3.5 dB <sup>2)</sup>

**General data**

Display	24 cm colour LC display (9.5") (VGA)		
Rated temperature range	+5 °C to +40 °C		
Power supply	200 V to 240 V/50 Hz to 60 Hz; 100 V to 120 V/50 Hz to 400 Hz,		
Power consumption	195 VA	230 VA	
Dimensions (W × H × D)	435 mm × 236 mm × 570 mm		
Weight	25.1 kg	26.4 kg	27.0 kg

1) According to CISPR 16 tolerance for impulse bandwidths and MIL-STD (-6 dB).

2) For RF frequencies >7 GHz: error after calling peaking function.  
For sweep time <10 ms/GHz: additional error ±1.5 dB.

## Ordering information

EMI Test Receiver		
20 Hz to 7 GHz	R&S® ESIB 7	1088.7490.07
20 Hz to 26.5 GHz	R&S® ESIB 26	1088.7490.26
20 Hz to 40 GHz	R&S® ESIB 40	1088.7490.40

**Accessories supplied**

Power cord, spare fuses, test port adaptor N (only R&S® ESIB 26+40), test port adaptor K (only R&S® ESIB 40), test port adaptor K (3.5 mm, only R&S® ESIB 26), PS/2 mouse, MF2 keyboard (US, DIN connector), EMI Test Software R&S® ESIB-K1 (pre-installed + CD)

**Options**

Preamplifier 20 dB, 7 GHz to 26.5 GHz	R&S® ESIB-B2	1137.4494.26
Preamplifier 20 dB, 7 GHz to 40 GHz	R&S® ESIB-B2	1137.4494.40
Vector Signal Analyzer	R&S® FSE-B7	1066.4317.02
Tracking Generator 7 GHz	R&S® FSE-B10	1066.4769.02
Switchable Attenuator for Tracking Generator	R&S® FSE-B12	1066.5065.02
Ethernet Card, RJ-45 connector	R&S® FSE-B16	1037.5973.04
Second IEC/IEEE-bus Card	R&S® FSE-B17	1066.4017.02
Removable Hard Disk for R&S® ESIB <sup>1)</sup>	R&S® FSE-B18	1088.6993.02
Second Hard Disk for R&S® ESIB, Windows NT	R&S® FSE-B19	1088.7248.10
External mixer output for R&S® ESIB 26/40	R&S® FSE-B21	1084.7243.02

**Software**

EMC Measurement Software (32 bit)	R&S® EMC 32-E	1119.4621.02
EMI Software for EMI Test Receiver (Windows)	R&S® ES-K1	1026.6790.02
Script Development Kit	R&S® ES-K2	1026.6890.02
Driver for R&S® ESIB 7/26/40	R&S® ES-K16	1108.0288.02
Driver for Mast (Schäfer) and Turntable (Schäfer)	R&S® ES-K30	1026.7196.02
Driver for MDS Absorbing Clamp Slideway (Schäfer)	R&S® ES-K31	1026.7921.02
Further driver software for R&S® ES-K1	on request	

**Extras**

Service Kit	R&S® FSE-Z1	1066.3862.02
DC Block, 5 MHz to 7000 MHz (type N)	R&S® FSE-Z3	4010.3895.00
DC Block, 10 kHz to 18 GHz (type N)	R&S® FSE-Z4	1084.7443.02
Microwave Measurement Cable and Adapter Set up to 26 GHz	R&S® FS-Z15	1046.2002.02
IEC/IEEE-Bus Cable, 1 m	R&S® PCK	0292.2013.10
IEC/IEEE-Bus Cable, 2 m	R&S® PCK	0292.2013.20
Control Cable 10 m, R&S® ES- IB-ESH2-Z5	R&S® EZ-5	0816.0625.03
Control Cable 10 m, R&S® ES- IB-ESH3-Z5	R&S® EZ-6	0816.0683.03
Control Cable 3 m, R&S® ES- IB-ENV 4200	R&S® EZ-21	1107.2087.03
Transit Case 19", 5 HU	R&S® ZZK-955	1013.9408.00
19" Rack Adapter, 5 HU	R&S® ZZA-95	0396.4911.00

**EMI accessories**

see data sheet PD 0756.4320

(Accessories for Test Receivers and Spectrum Analyzers)

For further extras for spectrum analyzer applications see data sheet PD 0757.1519 (Spectrum Analyzers R&S® FSE).

1) Factory-fitted.



Contents Overview

Chapter Overview

Type Index

R&amp;S Addresses



## Internal Preamplifier R&S® ESIB-B2

**Option for the EMI Test Receivers R&S® ESIB26/40 in the frequency range 7 GHz to 26.5/40 GHz**

### Brief description

The internal preamplifier (option R&S® ESIB-B2) is used to extend the frequency range of the preamplifier (9 kHz to 7 GHz) integrated as standard in the EMI Test Receivers R&S® ESIB26 and R&S® ESIB40 in the microwave range up to 26.5 GHz or 40 GHz. The preamplifier is used to improve the input sensitivity of the receivers by approximately 18 dB so that cable losses and antenna correction values can largely be compensated in the GHz range.

### Main features

- ◆ System noise figure improved by typ. 18 dB
- ◆ Nominal gain 20 dB
- ◆ Multistage configuration up to 26.5 GHz or 40 GHz
- ◆ Connection irrespective of operating mode: analyzer or receiver

### Specifications

The specifications below describe the additional data valid as of firmware version 4.01 or higher and are supplementary to the EMI Test Receivers R&S® ESIB data sheet (PD 0757.4576). Data designated "nominal" applies to design parameters and is not tested.

Displayed noise floor (receiver mode)		
(AV detector, 0 dB RF attenuation, RBW = 1 MHz, 50 Ω termination)		
	Model .26	Model .40
Preamplifier off		
7 GHz to 18 GHz	<22 dBμV	<26 dBμV
18 GHz to 26.5 GHz	<25 dBμV	<29 dBμV
26.5 GHz to 30 GHz	–	<40 dBμV
30 GHz to 40 GHz	–	<44 dBμV
Preamplifier on		
7 GHz to 18 GHz	<4 dBμV	<6 dBμV
18 GHz to 26.5 GHz	<6 dBμV	<9 dBμV
26.5 GHz to 30 GHz	–	<20 dBμV
30 GHz to 40 GHz	–	<26 dBμV

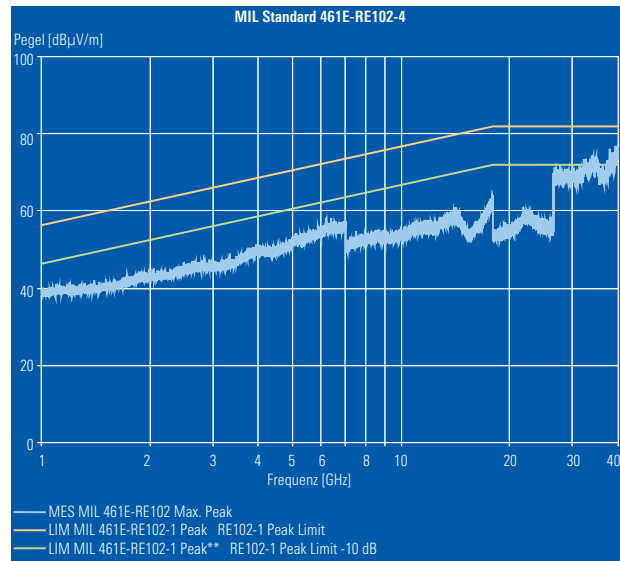

**Typical displayed average noise level of R&S® ESIB 40 with built-in Preamplifier R&S® ESIB-B2 (model .40), recorded with peak detector, measurement bandwidth (RBW) of 1 MHz and taking into account cable attenuation and correction factors of three horn antennas up to 18 GHz, 26 GHz and 40 GHz.**

Displayed noise floor (analyzer mode)		
(displayed average noise level, 0 dB RF attenuation, RBW = 10 Hz, VBW = 1 Hz, 20 averages, trace average, 50 Ω termination)		
Preamplifier off		
7 GHz to 18 GHz	<-135 dBm	<-131 dBm
18 GHz to 26.5 GHz	<-132 dBm	<-128 dBm
26.5 GHz to 30 GHz	–	<-117 dBm
30 GHz to 40 GHz	–	<-113 dBm
Preamplifier on		
7 GHz to 18 GHz	<-153 dBm	<-151 dBm
18 GHz to 26.5 GHz	<-151 dBm	<-148 dBm
26.5 GHz to 30 GHz	–	<-137 dBm
30 GHz to 40 GHz	–	<-131 dBm
Frequency response (10 dB RF attenuation)		
7 GHz to 18 GHz	±3 dB <sup>1)</sup>	±3 dB <sup>1)</sup>
18 GHz to 26.5 GHz	±3.5 dB <sup>1)</sup>	±3.5 dB <sup>1)</sup>
26.5 GHz to 40 GHz	–	±4 dB <sup>1)</sup>

<sup>1)</sup> Error after calling peak function. Additional error of ±1.5 dB for sweep time <10 ms/GHz.

### Ordering information

Internal Preamplifier		
7 GHz to 26.5 GHz	R&S® ESIB-B2	1137.4494.26
7 GHz to 40 GHz	R&S® ESIB-B2	1137.4494.40

## Miniport Receiver R&S® EB200

**Portable monitoring from**  
**10 kHz to 3 GHz with Handheld**  
**Directional Antenna R&S® HE200**



### Brief description

Miniport Receiver R&S®EB200 is a miniaturized portable professional receiver for the HF-VHF-UHF range. The R&S®EB200 is characterized by high input sensitivity and frequency setting accuracy throughout the frequency range from 10 kHz to 3 GHz.

Its small dimensions – ½ 19“, two height units – and low weight as well as a sturdy design make the R&S®EB200 ideal for use in places which cannot be reached with a vehicle. Its low power consumption permits battery operation typically of six hours. The R&S®EB200 battery pack is easily accessible and can be exchanged quickly. In case of power supply interruption, all the data are stored. Operation can thus be resumed immediately after the power supply is restored.

### Main features

- ◆ Ergonomic design for on-body operation
- ◆ Continuous frequency range 10 kHz to 3 GHz
- ◆ Digital IF section with 12 bandwidths (150 Hz to 150 kHz)
- ◆ Fast, accurate level indication across 120 dB dynamic range
- ◆ Search modes
  - Frequency search
  - Memory search
  - Frequency spectrum
- ◆ Remote-controllable via LAN (Ethernet 10 Base-T) or RS-232-C

### Function

The R&S®EB200 is a superhet receiver with a third intermediate frequency of 10.7 MHz. The receiver input is equipped with a highpass/lowpass combination or tracking preselection, as required, to

reduce the signal sum load. Intermodulation suppression equals that of many receivers used in stationary applications. The low degree of oscillator reradiation is a result of large-scale filtering. A modern synthesizer concept featuring very low phase noise permits switching times of less than 3 ms. Effective frequency and memory scanning is thus possible.

The digital IF section has a wide variety of different filters which are implemented in a minimal space with the aid of DSP. The R&S®EB200 has 12 IF bandwidths between 150 Hz and 150 kHz. The following digital demodulators are available: AM, FM, LSB, USB, CW, PULSE and IQ. If the receiver is fitted with the IF panorama option, the number of bandwidths is increased to 17 up to 1 MHz. Bandwidths over 150 kHz are for level and deviation measurement as demodulation is not possible.

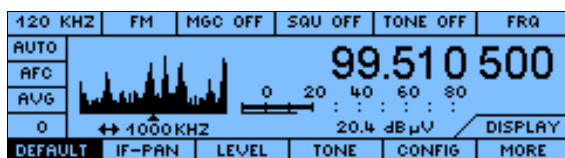

Overview

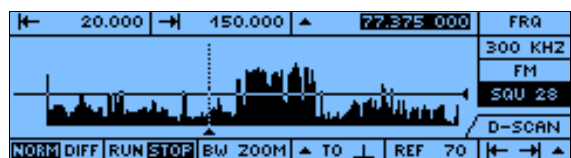

DIGI Scan listen mode

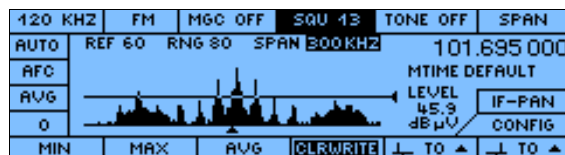

IF panoramic display

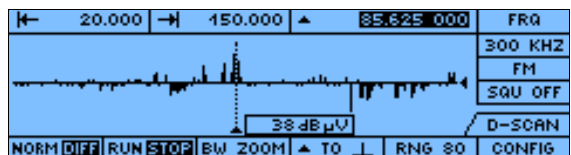

DIGI Scan differential mode



Contents Overview

Chapter Overview

Type Index

R&S Addresses



## Miniport Receiver R&S® EB200

### Applications

- ◆ Monitoring of given frequencies, e.g. storage of 1 to 1000 frequencies, squelch setting, constant monitoring of one frequency or cyclical scanning of several frequencies
- ◆ Searching in a frequency range with freely selectable start and stop frequency and step widths of 0.1 kHz to 10 MHz
- ◆ Search with highest speed in the frequency range with free selectable start and stop frequency (option DIGI scan)
- ◆ Location of close-range to medium-range targets with the aid of Handheld Directional Antenna R&S® HE200
- ◆ Detection of undesired emissions including pulsed emissions
- ◆ Detection of unlicensed transmitters communicating illegally or interfering with licensed transmission
- ◆ Protection against tapping by detecting miniature spy transmitters (bugs)
- ◆ Monitoring of one's own radio exercises in a service band
- ◆ Monitoring of selected transmissions
- ◆ Remote-controlled operation via modem and PC in coverage measurement and monitoring systems

### Handheld Directional Antenna

The handy and highly broadband Active Directional Antenna R&S® HE200 in conjunction with portable receivers such as R&S® EB200 is ideal for locating transmitting and interfering sources. The direction is found by pointing the antenna towards the direction of maximum signal voltage. The overall frequency range from 0.01 MHz to 3000 MHz is covered by 4 exchangeable broadband antenna modules each with a distinct directional pattern.

A low-noise broadband amplifier may be added to increase sensitivity in the active mode. The amplifier is bypassed in the passive mode and in this case the antenna may also be used in the vicinity of strong transmitters.

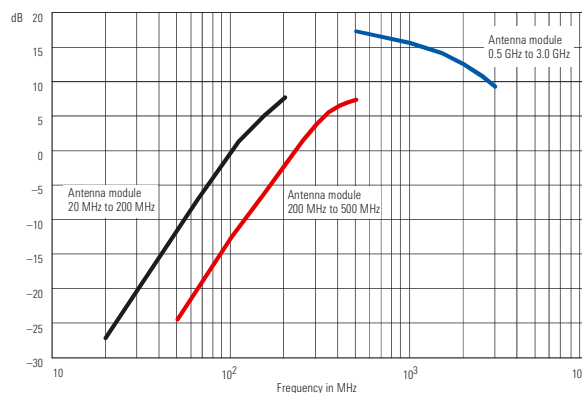

Gain, active mode



Contents Overview

Chapter Overview

Type Index

R&S Addresses





Contents Overview

Chapter Overview

Type Index

R&amp;S Addresses



## Miniport Receiver R&S® EB200

### Specifications in brief R&S® EB200

You will find detailed and binding data on the enclosed CD (./DATASHEET/EB200.pdf), or, for the latest updates, visit [www.rohde-schwarz.com](http://www.rohde-schwarz.com), search term: EB200

<b>Frequency range</b>	10 kHz to 3 GHz
Frequency setting via keypad or rollkey	1 kHz, 100 Hz, 10 Hz, 1 Hz or in selectable increments
Frequency accuracy	$\leq 1 \times 10^{-6}$ (–10°C to +55°C)
Aging	$\leq 0.5 \times 10^{-6}$ /year
Synthesizer setting time	$\leq 3$ ms
Oscillator phase noise	$\leq -100$ dBc (1 Hz) at 10 kHz offset
<b>Antenna input</b>	N female, 50 $\Omega$ , VSWR $\leq 3$ , SMA connector on rear panel for rack mounting
Oscillator reradiation	$\leq -107$ dBm
Input attenuation	manual or automatic
Input selection	
100 kHz to 20 MHz	highpass/lowpass
20 MHz to 1.5 GHz	tracking preselection
1.5 GHz to 3 GHz	highpass/lowpass
<b>Interference rejection, nonlinearities</b>	
Image frequency rejection	$\geq 70$ dB, typ. 80 dB
IF rejection	$\geq 70$ dB, typ. 80 dB
2nd order intercept point	typ. 40 dBm
3rd order intercept point	typ. 2 dBm
Internal spurious signals	$\leq -107$ dBm
<b>Sensitivity</b>	
Overall noise figure	typ. 12 dB
Demodulation	AM, FM, LSB, CW, PULSE, IQ
IF bandwidths	12 (150/300/600 Hz/1.5/2.5/6/9/15/30/50/120/150 kHz)
IF bandwidths for level and deviation indication	15 (150 Hz to 1 MHz) only with IF Panoramic Unit R&S® EB200SU
Squelch	signal-controlled, can be set from –30 dB $\mu$ V to 110 dB $\mu$ V
Gain control	AGC, MGC
AFC	digital retuning for frequency-unstable signals
Deviation indication	graphical with tuning label or numerical
Signal level indication	graphical as level line or numerical from –10 to 110 dB $\mu$ V, acoustic indication by level tone
IF panorama (option SU)	internal module, ranges 25, 50, 100, 200, 500, 1000 kHz, all IF bandwidths additional 25 kHz to 1 MHz
<b>Scan characteristics</b>	
Automatic memory search	1000 definable memory locations to each of which a complete data set can be allocated
Frequency search	START/STOP/STEP definition with receiving data set
RF spectrum DIGI scan (option)	start/stop, up to 1.5 GHz/sec
<b>Inputs/outputs</b>	
Digital IF output	serial data (clock, data, frame) up to 256 kbps
I/Q output (digital)	AF signal, 16 bit
IF 10.7 MHz, wideband	typ. $\pm 5$ MHz uncontrolled for external panoramic display
AF output, balanced	600 $\Omega$ , 0 dBm
Loudspeaker output	8 $\Omega$ , 500 mW
Headphones output	via volume control
Output log. signal level	0 V to +4.5 V



Contents Overview

Chapter Overview

<b>BITE</b>	monitoring of test signals by means of loop test
<b>Data interface</b>	LAN (Ethernet 10 Base-T) or RS-232-C

### General data

Operating temperature range	–10°C to +55°C
Rated temperature range	0°C to +50°C
Storage temperature range	–40°C to +70°C
Power supply	110/230 V AC, 50/60 Hz battery pack (typ. 6 h operation) or 10 V to 30 V DC (max. 22 W)
Dimensions (W × H × D)	210 mm × 88 mm × 270 mm, ½ 19" × 2 HU
Weight (without battery pack)	4 kg
Battery pack	1.5 kg

### Specifications in brief R&S® HE200

Frequency range	0.01 MHz to 3000 MHz
Antenna modules	20 MHz to 3000 MHz, with 3 plug-in antennas
20 MHz to 200 MHz	loaded loop antenna
200 MHz to 500 MHz	loaded loop antenna
500 MHz to 3000 MHz	log-periodic antenna
Option	
0.01 MHz to 20 MHz	loop antenna
Polarization	vertical for all antenna modules, horizontal polarization by turning the longitudinal antenna axis by 90°
Loop antenna 0.01 MHz to 20 MHz	direction finding for horizontally polarized signals not possible because of circular vertical pattern of system
Nominal impedance	50 $\Omega$
SWR	typ. <2.5
RF output	1 m cable with N connector

### General data

Operating temperature range	–10°C to +55°C
Rated temperature range	0°C to +50°C
Power supply	in handle, 4 × 1.5 V mignon cell R6
Dimensions (W × H × D)	470 mm × 360 mm × 180 mm (in transport case)
Weight (without battery)	4.5 kg including transport case

### Ordering information

<b>Miniport Receiver</b>	R&S® EB200	4052.2000.02
<b>Options</b>		
Internal IF Panoramic Unit	R&S® EB200SU	4052.3206.02
RF Spectrum DIGI-Scan	R&S® EB200DS	4052.9604.02
LAN (Ethernet 10 Base-T) Interface	R&S® EB200R4	4052.9156.02
RS-232-C Interface	R&S® ESMBR2	4052.9156.02
<b>Extras</b>		
Carrying Case (telescopic antenna, headset, belt and space for R&S® EB200 and battery pack)	R&S® EB200SC	4052.9304.02
Battery Pack	R&S® EB200BP	4052.4102.02
Handheld Directional Antenna inclusive carrying case	R&S® HE200	4050.3509.02
HF Module 10 kHz to 20 MHz	R&S® HE200HF	4051.4009.02



Contents Overview

Chapter Overview



Type Index



R&amp;S Addresses



## EMI Software R&S® ES-K1

**Automation of EMI measurements with Rohde&Schwarz instruments:**

**Analyzer families**

**R&S® ESIB and R&S® ESPI**

**Further analyzers/test receivers on request**

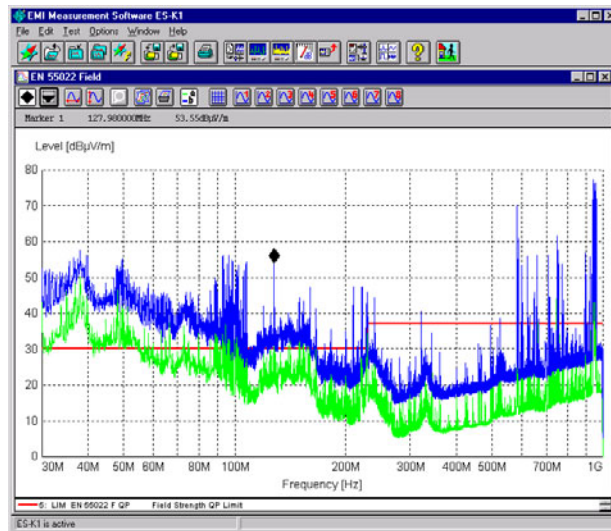

*The frequency spectrums for two or more (depending on receiver type) different detectors measuring in parallel are shown simultaneously.*

## Brief description

EMI Software R&S® ES-K1 is a versatile, efficient and user-friendly tool for fully automatic measurement of conducted and radiated emissions to international commercial and military standards such as CISPR, VDE, FCC, EACL, ANSI, EN; MIL, VG, DEF-STAN, GAM-EG13.

Offering various drivers, the software not only supports EMI test receivers and EMI spectrum analyzers from Rohde&Schwarz, but also a large variety of accessories:

- ◆ Mast and turntable system for measurement of RFI field strength
- ◆ Artificial mains networks and absorbing clamp slideways for measurement of conducted emissions
- ◆ Matrix for switching over antennas and transducers

## Main features

- ◆ User-friendly EMI test software under Windows
- ◆ EMI measurements to commercial and military standards
- ◆ Adaptation to other standards

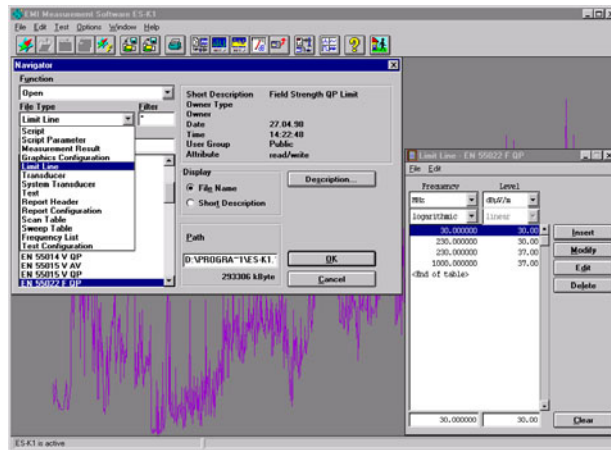

*The integrated data-base contains a large number of predefined limit lines, transducer factors and scan or sweep tables that can easily be selected via a navigator and edited.*

- ◆ Integrated database
- ◆ User-group-specific data allocation
- ◆ Fully automatic operation or interactive single measurement
- ◆ Automatic compensation of transducers (correction factors) and limit lines
- ◆ Large choice of data reduction methods
- ◆ Azimuth chart test
- ◆ Evaluation of narrowband/broadband interferers
- ◆ Test setup calibration
- ◆ Convenient and flexible result documentation and report generation
- ◆ Universal data storage
- ◆ Hardlock key (dongle) for authentication
- ◆ Network-compatible

## Test runs

Depending on the application and use of the software, control of the test runs is either fully automatic or interactive. By loading automatic test routines defined in the form scripts, measurements can be started simply at the press of a button without any time-consuming entries. The scripts control the test run, evaluate the results and generate the necessary test reports. In addition to standard scripts, user-specific scripts can be generated and existing scripts modified (option R&S® ES-K2).

## EMI Software R&S® ES-K1

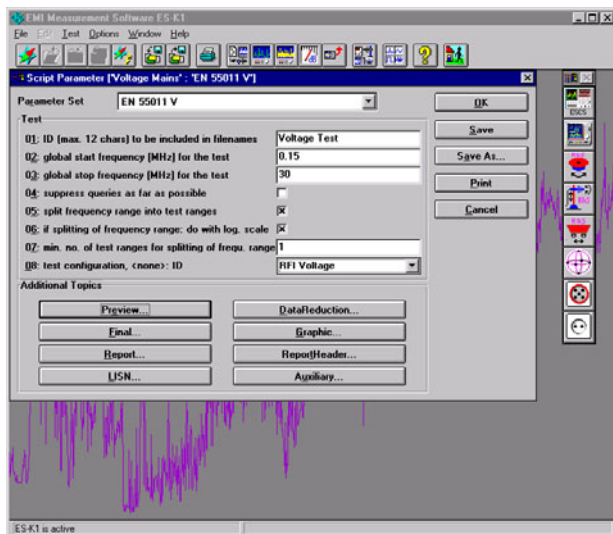

Standard parameter configuration enables standard-compliant measurement with flexible scripts.

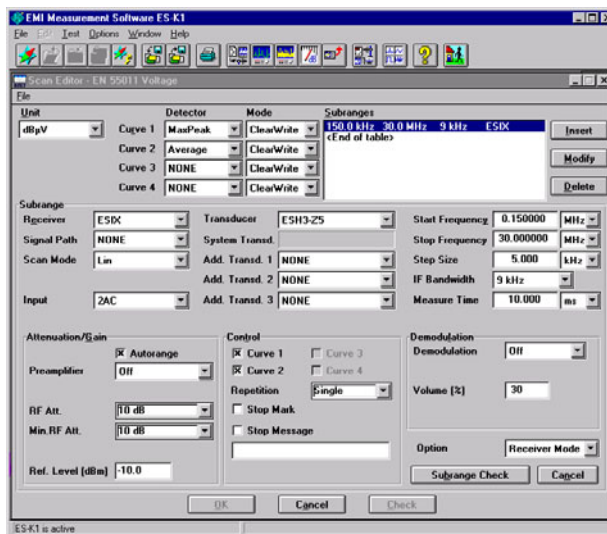

The measurement parameters for frequency subranges can additionally be optimized in standard preset scan tables.

A database is integrated in R&S® ES-K1 for management of the measured data or of the result files derived with the aid of comprehensive test and evaluation routines. The convenient access to these files with informative short descriptions does away with tiresome file searching.

Versatile and flexible result display is possible in the form of tables or graphs. A maximum of eight test results, limit lines and transducer factors can be displayed simultaneously.

A zoom function allows enlargement of any parts of the result display.

### Report generation

By using the integrated report configuration file, users can customize their test reports to a large extent. In addition to a report header, all measurement-relevant data can be output. The measurement results, limit lines and transducer factors are output in tables or graphics.

During report generation, the protocol can be viewed prior to printing by using PRINT REVIEW. Moreover, graphics, tables as well as RTF files can be stored. Another asset is the flexible configuration of the test reports, allowing users to insert graphics, tables or measurement result lists where needed by means of a common text program (e.g. Word). Any Windows-supported printer can be used.

### Hardware requirements

IBM compatible PC minimum 486 with Windows 3.1/95/98/NT4.0/2000/ME; minimum 8-MByte RAM; minimum memory capacity on hard disk 8 Mbyte; IEC/IEEE bus interface with Windows driver (DLL), National Instruments IEC/IEEE bus interface.

### Ordering information

<b>EMI Software</b>	R&S® ES-K1	1026.6790.02
(Windows program with driver for Artificial Mains Networks R&S® ESH2-Z5, R&S® ESH3-Z5 and Relay Matrixes R&S® PSU, R&S® RSU and R&S® PSN)		
Script Development Kit	R&S® ES-K2	1026.6890.02

Drivers for Test Receivers and Spectrum Analyzers		
R&S® ESHS/ESVS/ESVD/ESCS/ESPC	R&S® ES-K10	1026.6948.02
R&S® ESAI/ESBI/ESMI	R&S® ES-K12	1026.7144.02
R&S® ESIB 7/26/40	R&S® ES-K16	1108.0288.02
R&S® ESPI3/7	R&S® ES-K18	1140.5298.02
Drivers for accessories		
Schäfer Mast and Turntable	R&S® ES-K30	1026.7196.02
Deisel Controller, Mast, Turntable, HD-MA2xx and HD-DT3xx	R&S® ES-K33	1035.1097.02
EMCO Controller, Mast, Turntable, 2090 and SUNOL SC9XV	R&S® ES-K40	1140.4591.02
User specific IEC/IEEE Bus Driver	R&S® ES-K50	1057.2496.02
Multi-User Licence	R&S® ES-K100	1057.0741.02
Further drivers on request.		

## EMC Measurement Software R&amp;S® EMC32

For use in development, for compliance and batch testing

*R&S® EMC32 display for single EMI measurements; parameters such as current measurement frequency, detectors, bandwidth, measurement time, demodulation or RF attenuation can be varied during the measurement*

## Brief description

The EMC Measurement Software R&S® EMC32 runs on 32-bit operating systems from Microsoft and offers a common user interface for electromagnetic interference (EMI) and electromagnetic susceptibility (EMS) measurements. The software is a modern and powerful tool for controlling and monitoring Rohde&Schwarz EMI test receivers and EMC test systems. It guarantees reliable collection, evaluation and documentation of measurement results.

Thanks to its comprehensive and extremely flexible configuration capabilities and its open software structure, R&S® EMC32 can be used for all EMI and EMS measurements in line with civil standards.

## Main features

**Flexible**

- ◆ Modules for measuring electromagnetic interference (EMI) and electromagnetic susceptibility (EMS)
- ◆ Support of measurements to civil standards such as CISPR, IEC, ISO, EN, ETSI, VDE, FCC and ANSI

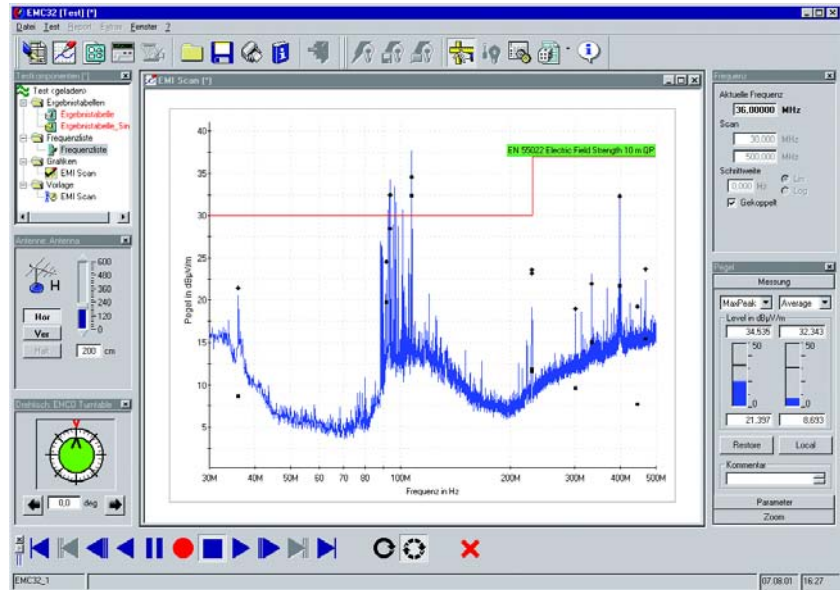

- ◆ Manual and automatic EMI and EMS measurements
- ◆ Can be combined with EMC test systems and EMI test receivers/analyzers from Rohde&Schwarz

**Efficient**

- ◆ Graphical user interface for instrument and system configuration
- ◆ Menu-guided, intuitive user prompting for all test sequences (virtual instrument)
- ◆ Product-oriented test selection
- ◆ EUT-specific data management
- ◆ Modular calibration concept
  - Minimal recalibration effort required
  - Simplified test system certification
- ◆ Assisted installation and configuration
- ◆ Online help

**Future-oriented**

- ◆ Modular program structure
- ◆ Easily upgradeable
- ◆ Data storage in text format
- ◆ Reports generated as RTF, HTML or PDF file
- ◆ 32-bit software for Windows 2000 and XP

## Applications

An essential feature of the R&S® EMC32 software is that it can be optimally adapted to the requirements of the various EMC applications:

**Tests during development**

Switchover between manual and automatic measurements at any time

**Compliance testing**

Standard measurements can be performed easily and rapidly with the aid of predefined test routines and an integrated EUT monitoring function (EMS)

**Batch tests**

The capability to perform graphical batch measurements is ideal for batch testing

The R&S® EMC32 software offers EMI and EMS measurements for all civil product groups:

- ◆ Industrial, scientific and medical RF instruments (ISM instruments)
- ◆ Broadcast receivers and connected units



## EMC Measurement Software R&S® EMC32

- ◆ Domestic appliances and tools
- ◆ Fluorescent lamps and lighting systems
- ◆ Information technology equipment (ITE)
- ◆ Communications equipment
- ◆ Automotive products

The limit values for the applicable international standards are already included in the software. Furthermore, new test criteria can be generated by the user, stored as standard and considered as manufacturer- or product-specific limit values. This makes the software user-configurable for almost any EMC measurement task.

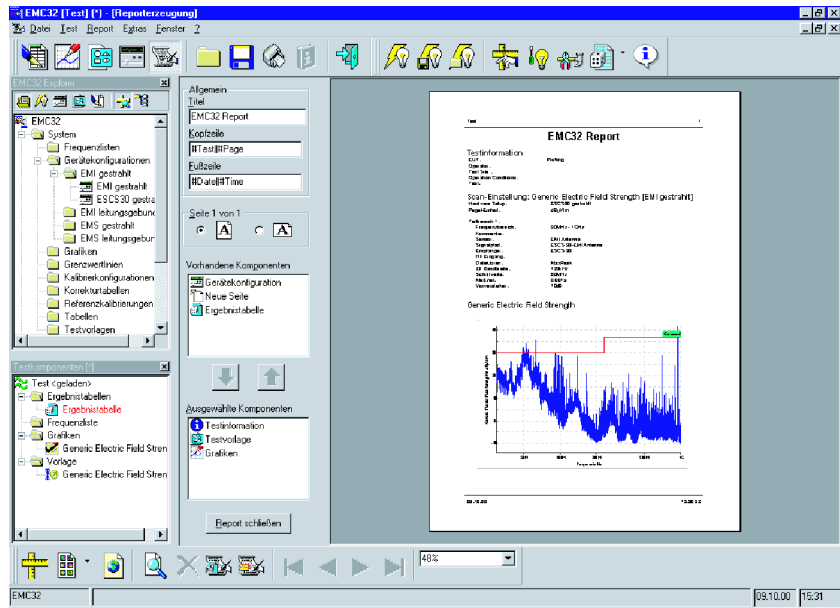

*R&S® EMC32 with report configuration dialog open; a report consists of several parts, e.g. header, graphs, tables, test template settings, which can be configured and arranged in this dialog*

## Specifications/system requirements

<b>Operating system</b>
Windows 2000 or XP (other MS OS on request)
<b>Administration rights</b>
Microsoft Internet Explorer 5.0 or higher
PC with Pentium class processor (at least 200 MHz)
128 Mbyte RAM
50 Mbyte free hard disk space
Super VGA monitor, screen resolution at least 1024 × 768 pixels, 65536 colours
USB interface integrated in the motherboard (for i-Key software protection) <sup>1)</sup>
IEC/IEEE-bus interface card from National Instruments

<sup>1)</sup> Software protection: R&S® EMC32 is protected by a hardware dongle (i-Key). When used for demonstrations or without control of (hardware) system components, R&S® EMC32 can be installed on a computer without further registration and can be operated without an i-Key.

### Available software modules:

R&S® EMC32 is available as a complete package for EMI and EMS measurements or as single packages for EMI or EMS measurements.	
R&S® EMC32-C	for electromagnetic interference and susceptibility test systems (EMI + EMS)
R&S® EMC32-E	for electromagnetic interference test systems (EMI)
R&S® EMC32-S	for electromagnetic susceptibility test systems (EMS)

The R&S® EMC32-E (EMI) software version supports the following Rohde&Schwarz EMI test receivers:  
 EMI Test Receivers R&S® ESIB 7/26/40  
 EMI Test Receiver R&S® ESCS30  
 Test Receiver R&S® ESPI3/7  
 EMI Test Receiver R&S® ESAI/ESBI/ESMI  
 EMI Test Receiver R&S® ESx30

An overview of further currently available device drivers (RF generators, mast and turntable controllers, etc) of R&S® EMC32 is provided on the Rohde&Schwarz website at [www.emc32.rohde-schwarz.com](http://www.emc32.rohde-schwarz.com).

## Ordering information

EMC Measurement Software R&S® EMC32		
Options		
for EMI and EMS package	R&S® EMC32-A	1159.6260.02
Multi-User Lizenze for EMI and EMS Automotive Application System Software R&S® EMC32-A	R&S® EMC32MA	1163.2720.02
for EMI and EMS package	R&S® EMC32-C	1119.4644.02
for EMI and EMS package (separate hard-locks for EMI and EMS)	R&S® EMC32-C	1119.4644.03
Multi-User Lizenze for EMI and EMS Application System Software R&S® EMC32-C	R&S® EMC32MC	1140.7778.02
for EMI package	R&S® EMC32-E	1119.4621.02
for Test Receivers R&S® ESPI3 and R&S® ESPI7	R&S® EMC32-L	1106.4286.02
for EMS package	R&S® EMC32-S	1119.4638.02
Multi-User Lizenze for EMS Application System Software R&S® EMC32-S	R&S® EMC32MS	1140.7761.02

## EMI Measurement Software R&S®EMC32E+

For manual and automated EMI measurements



### Brief description

R&S®EMC32-E+ is used to measure RFI voltage, power and field strength, and it runs on the current 32-bit operating systems from Microsoft. It is based on EMC Measurement Software R&S®EMC32 and supports both manual as well as partially and fully automated EMI measurements to civil and military standards. This ensures reliable acquisition, analysis, documentation and traceability of measurement results.

### Main features

#### Efficient

- ◆ Graphical operating concept for configuring instruments and measurement systems
- ◆ Menu-guided, intuitive user interface for all measurements
- ◆ EUT-specific test selection and data management
- ◆ Assisted installation and configuration
- ◆ Online help

#### Flexible

- ◆ Measurements of RFI voltage, RFI power and RFI field strength

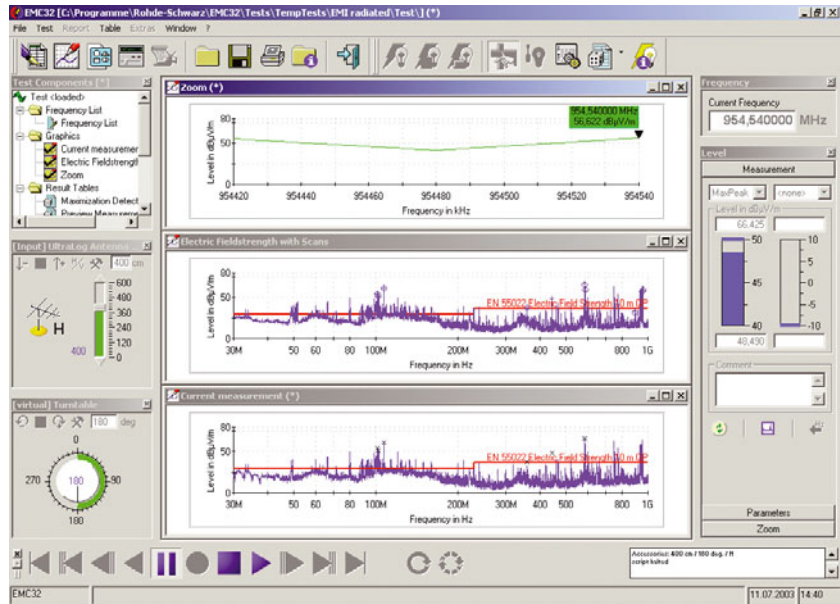

*The R&S®EMC32-E+ screen as a "virtual" measurement instrument: Measurement mode view during measurement of RFI field strength. The test components explorer provides an overview of all loaded files of the current measurement. Below it are the (automatic or manual) settings for mast and turntable. In the center are the measurement zoom graphics for frequency optimization, the overall result with a separate trace for each result table as well as the active measurement (scan/sweep). The windows on the right provide information about the frequency setting of the test receiver and display the current measurement result numerically and as a bar graph (ClrWrite and MaxHold). The symbols at the bottom control measurement operation (pause, stop, start).*

- ◆ Support of measurements to civil and military standards (CISPR, EN, ETS, FCC, VCCI, VDE, MIL-STD, DEF-STAN)
- ◆ Manual, semi-automated and fully automated EMI measurements
- ◆ Combined use possible with all current EMI test receivers/analyzers from Rohde&Schwarz
- ◆ Drivers for numerous accessory components included

*EUT-oriented test directory structure in the R&S®EMC32-E+ file explorer. A test directory contains all measurement results plus the associated test templates, device configurations, limit lines and correction tables (transducers), which clearly define how the measurement results were obtained. This ensures traceability of results as well as reliable reproducibility of measurements (important for accreditation).*

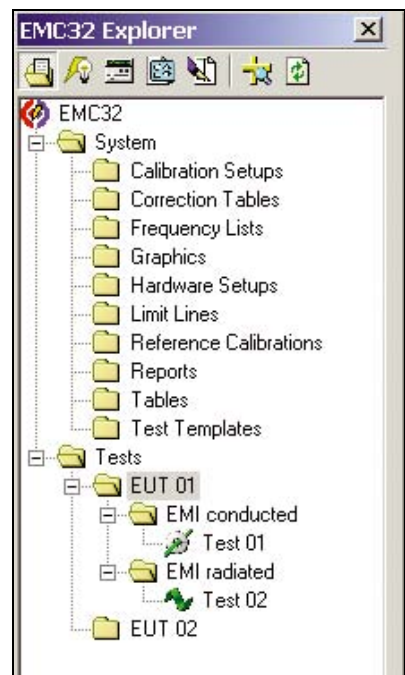



## EMI Measurement Software R&S®EMC32E+

### Future-oriented

- ◆ Modular program structure
- ◆ Data storage in text format
- ◆ Report generation also as PDF, RTF and HTML file
- ◆ 32-bit software, for WindowsXP and Windows2000

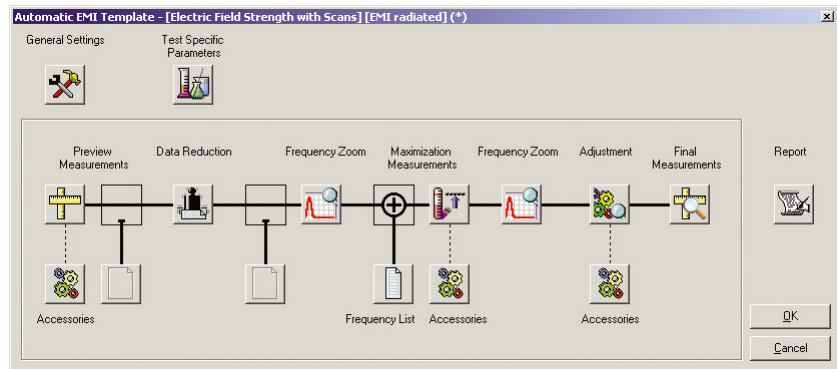

*Test template of an automatic RFI field strength measurement with the setting elements for preview measurement, data reduction, optional maximization of the critical frequencies with positioning of accessories, final measurement and report generation.*

### Specifications/system requirements

Operating system: WindowsXP or Windows2000
Administrator rights (for installation)
Microsoft Internet Explorer 5.0 or higher
PC with Pentium processor (min. 500 MHz)
256 Mbyte RAM (WindowsXP) or 128 Mbyte RAM (Windows2000)
100 Mbyte free hard disk space
Minimum screen resolution 1024 × 768 pixels, 65536 colours
USB interface, integrated into the motherboard (for i-Key software protection <sup>1)</sup> )
IEC/IEEE bus interface card from National Instruments
<b>Available software modules</b>
The following modules of EMC Measurement Software R&S®EMC32 are available:
R&S®EMC32-C: for electromagnetic interference and susceptibility test systems (EMI + EMS)
R&S®EMC32-A: for automotive test systems (EMI + EMS)
R&S®EMC32-E/E+: for electromagnetic interference test systems (EMI)
R&S®EMC32-S: for electromagnetic susceptibility test systems (EMS)
R&S®EMC32-L: for electromagnetic interference test systems (EMI) only in conjunction with the Test Receiver R&S®ESPI
Software modules R&S®EMC32-A, -E and -E+ support all current Rohde&Schwarz EMI test receivers/analyzers

### Ordering information

EMI Measurement Software	R&S®EMC32-E+	1501.9590.02
--------------------------	--------------	--------------





Contents Overview

Chapter Overview

Type Index

R&amp;S Addresses



## EMI Software R&S® ESxS-K1

**User-friendly EMI test software  
under Windows**

**Can be used for all Test Receivers of  
family R&S® ESxS**



### Brief description

EMI Software R&S® ESxS-K1 combines the main features of commercial EMI measurement requirements in one complete, easy-to-use application including: setup definition and storage, scan data capture and display with automatic data reduction, peak search with acceptance margin and subrange selection, final measurement with worst case selection, report generation and measured data storage.

R&S® ESxS-K1 provides for all test receiver and EMI test receiver families (except R&S® ESPI/ESIB/ESxI) a low-cost Windows based remote-control display and result storage solution.

Much benefits of Windows are available including: keyboard and mouse operation, report printout on any printer/plotter supported by Windows, and dynamic data exchange (DDE). Online help explains all software functions, so no user manual is required.

### Main features

- ◆ Full on-screen setup entry and storage to disk, including limit lines and transducer factors
- ◆ Colour graphic display of scan data, with automatic data reduction
- ◆ Marker function, including Marker to Peak and Tune Receiver to Marker Frequency
- ◆ Automatic Peak Search with user-definable acceptance margin and subrange/peak value count
- ◆ Peak List Edit function for automatic, semi-automatic or manual measurements
- ◆ Find Worst Case function: to find max hold level
- ◆ Zoom function: expands frequency axis to display a part of the scan in greater detail
- ◆ Report generation compatible with R&S® ESxS receiver family using any printer or plotter supported by Windows
- ◆ Report data export to other applications (WinWord, Excel)

### Hardware/software requirements

IBM-compatible machine with an 80486 processor or higher, Windows9x/ME/NT4.0/2000/XP; requires an IEC/IEEE bus interface card for receiver control, e.g. PS-B4 (model .04) from Rohde&Schwarz, or PCII/IIA, AT-GBIP from National Instruments.

### Ordering information

EMI Software	R&S® ESxS-K1	1082.9678.02
--------------	--------------	--------------



Contents Overview

Chapter Overview

Type Index

R&amp;S Addresses





Contents Overview

Chapter Overview

Type Index

R&S Addresses



## Absorbing Clamps R&S®MDS-21/-22, Ferrite Clamp R&S®EZ-24

**RFI power and shielding effectiveness measurements on lines.**  
**Reproducible interference field-strength and power measurements**

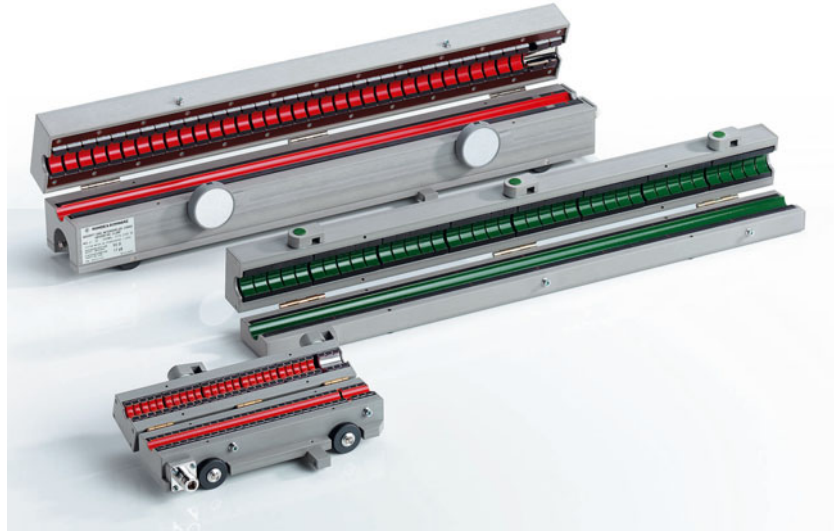

*Absorbing Clamps R&S®MDS-21 and R&S®MDS-22; center: Ferrite Clamp R&S®EZ-24*

### Brief description

The RFI emission of electrical appliances, machinery and systems must be kept within the limits specified by regional and international standards. Absorbing Clamps MDS can be used in conjunction with EMI test receivers to measure RFI power on lines to CISPR 14-1, EN 55014-1, VDE0875 Part 14 and EN 50083-2, and in conjunction with two-port measurement devices to measure the shielding effectiveness of lines to DIN 47250 Part 6, IEC 96-1, EN 50083-2 and DIN 0855 Part 200. MDS clamps are also used for testing the effectiveness of RFI suppression

devices for high-voltage ignition systems in line with VDE0879 Part 4 and CISPR 12 (5th edition). Draft documents for the measurement of radiated interference provide for the use of ferrite absorbers for line loading to improve the reproducibility of RFI field-strength measurements. Ferrite absorbers are also used to improve RFI power and shielding effectiveness measurements.

### Interference measurements in the VHF/UHF range

In the frequency range below 30 MHz, where interference is mainly propagated via lines, this interference is determined

as laid down in many regulations by measuring the RFI voltage produced by the EUT across the terminals of a line-impedance stabilization network.

In the VHF/UHF range, where radiated emission predominates, interference is defined in terms of the RFI field strength at a certain distance. Small EUTs emit interference mainly via the connecting cables such as power lines. For the above reasons as well as to avoid complex field-strength measurement, several regulations prescribe the use of an absorbing clamp for measurement of the RFI power.

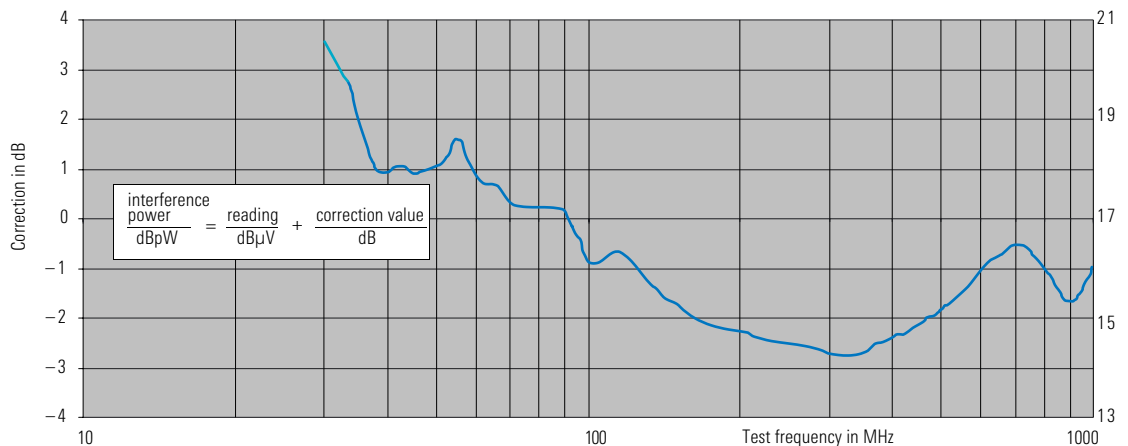

*Typical calibration curve of Absorbing Clamp R&S®MDS-21*



Contents Overview

Chapter Overview

Type Index

R&S Addresses





Contents Overview

Chapter Overview

Type Index

R&S Addresses



## Absorbing Clamps R&S®MDS-21/-22, Ferrite Clamp R&S®EZ-24

### Further applications

In addition to measuring the interference emitted by small appliances and the shielding effectiveness of cables, Absorbing Clamp R&S®MDS-21 can also be used for testing the effectiveness of RFI suppression devices for high-voltage ignition systems according to VDE0879 Part 4/Draft 9.89 and CISPR 12. High-energy pulses are coupled out and taken to the test receiver whose inputs are protected in a special way.

MDS clamps are also suitable for use as coupling clamps for testing the susceptibility of electronic devices.

*Insertion loss characteristic of Ferrite Clamp R&S®EZ-24*

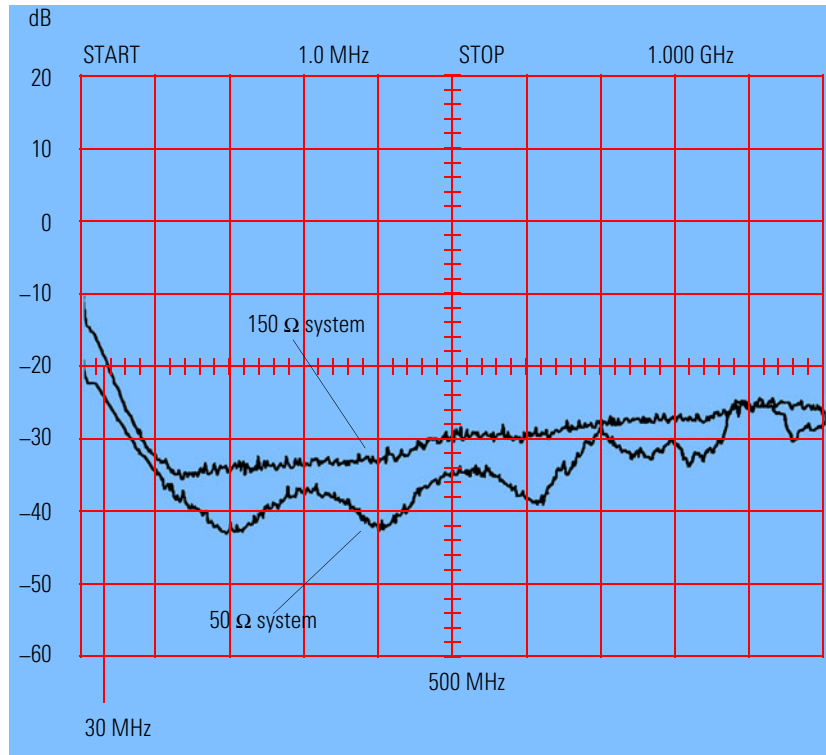

### Specifications

	R&S®MDS-21	R&S®MDS-22
Frequency range	30 MHz to 1000 MHz	300 MHz to 2500 MHz
Insertion loss to CISPR 16-1, typ.(individual calibration report supplied with clamp)	17 ±4 dB	17 +6/-4 dB
Calibrated for receiver input impedance	50 Ω	50 Ω
Connector	N female 50 Ω	N female 50 Ω
Permissible DC current or peak value of AC current	30 A	50 A
Max. permissible RF input power for susceptibility measurement	5 W	5 W
Max. cable diameter	20 mm	12 mm
Insert sleeves supplied (diameter)	10 mm	3, 6, 9 mm
Rollers	ball bearing, dust-protected	ball bearing, dust-protected
Overall dimensions		
W × H × D in mm	610 × 115 × 80	230 × 70 × 70
Weight	6.3 kg	1.25 kg

	R&S®EZ-24
Frequency range	1 MHz to 1000 MHz
Skin current attenuation in range 30 MHz to 1000 MHz in 50 Ω circuit	>15 dB (see typ. insertion loss)
Max. permissible skin current RF power	50 W
Overall dimensions	
W × H × D in mm	626 × 57 × 80
Weight	3.5 kg

### Ordering information

<b>Absorbing Clamp</b>	R&S®MDS-21	0194.0100.50
	R&S®MDS-22	1052.3507.02
<b>Ferrite Clamp</b>	R&S®EZ-24	1107.2535.02
<b>Accessories supplied</b>		
R&S®MDS-21	1 coaxial connecting cable (for connecting R&S®MDS-21 to EMI test receiver), 5 m long with 2 × N connector; 6 dB attenuator, 2 × N connector	
R&S®MDS-22	1 calibration curve without cable insertion loss (insertion loss of connecting cable must be added)	



Contents Overview

Chapter Overview

Type Index

R&S Addresses





Contents Overview

Chapter Overview

Type Index

R&amp;S Addresses



## Triple-Loop Antenna R&amp;S®HM020

9 kHz to 30 MHz

van Veen/Bergervoet system:

more sensitive, faster and cheaper

than former test methods to

CISPR Publication 16

Standards: CISPR 15, CISPR 16-1,

CISPR 11/12.97



Normal setup



Test setup with reduced height

## Brief description

Test method to CISPR 16-1 for electric lighting equipment to CISPR 15 and for induction sources to CISPR 11

- ◆ Fully automatic measurement of the magnetic field strength in the X, Y and Z planes of a centrally placed EUT

## Main features

- ◆ Automatic control with Software R&S®ES-K1 from test receivers or manual remote control from optional Control Unit R&S®BG020
- ◆ Loop system suitable for mobile use; can be folded in one plane
- ◆ Wooden pedestals (100 kg load capacity) for various installation heights available
- ◆ Neither EUT nor loop need to be turned during the measurement
- ◆ The effect of the shielded room on the test result is considerably reduced
- ◆ Ambient interference is strongly suppressed in open-area measurements
- ◆ The antenna is factory-calibrated with the Calibration Dipole R&S®HM020Z3 placed at the antenna center, which is available to the user for recalibration

## Specifications in brief

Frequency range	9 kHz to 30 MHz
Loops	switchable between X, Y and Z planes
Transducer factor of current probe	0 dB, referred to 1 S
RF connector	N female, 50 Ω
Dimensions (W × H × D); weight	
Loops set up, normal mode	2.49 m × 2.57 m × 2.07 m; 45 kg
Loops set up, reduced height	2.49 m × 2.09 m × 2.07 m
Transport crate	2.68 m × 2.32 m × 0.57 m
Basic Pedestal R&S®HM020Z1	0.9 m × 1 m × 0.9 m; 40 kg
Adapter Pedestal R&S®HM020Z2	0.9 m × max. 0.5 m × 0.9 m; 30 kg

## Ordering information

<b>Triple-Loop Antenna</b>	R&S®HM020	4023.4508.02
<b>Extras</b>		
Control Unit	R&S®BG020	4024.1002.02
Basic Pedestal	R&S®HM020Z1	4023.5504.02
Adapter Pedestal	R&S®HM020Z2	4023.5604.02
Calibration Dipole	R&S®HM020Z3	4023.5704.02
Control Cable	R&S®EZ-14 (included)	1026.5341.05



Contents Overview

Chapter Overview

Type Index

R&amp;S Addresses





Contents Overview

Chapter Overview

Type Index

R&S Addresses



## Active Antennas R&S® AM524, R&S® HM525

### Active Antenna System

**R&S® AM524: 100 Hz to 1 GHz**

### Active H-Field Test Antenna

**R&S® HM525: 100 Hz to 30 MHz**

### Brief description

For measuring unwanted, compromising emissions, antennas are required which allow detection of extremely low-level signals. Active Antennas R&S® AM524 and R&S® HM525 are able to measure signals with a level 10 dB to 20 dB lower than that of signals that can be measured with conventional EMC test antennas. Therefore they are mainly used in anechoic chambers.

### Equipment supplied

R&S® AM524 consists of three antennas (R&S® HE525, R&S® HE526 and R&S® HE527) with the appropriate junction units, a basic unit with power supply, transit case and support. R&S® HM525 requires the same peripheral devices as R&S® AM524.

### Specifications in brief

Frequency	Sensitivity at 1 Hz bandwidth			
	R&S® HE525	R&S® HE526	R&S® HE527	R&S® HM525
100 Hz	0 dB(µV/m)			18 dB(µA/m)
1 kHz	-18 dB(µV/m)			-22 dB(µA/m)
10 kHz	-35 dB(µV/m)			-50 dB(µA/m)
100 kHz	-43 dB(µV/m)			-68 dB(µA/m)
1 MHz	-48 dB(µV/m)			-88 dB(µA/m)
10 MHz	-49 dB(µV/m)			-93 dB(µA/m)
30 MHz	-51 dB(µV/m)	-49 dB(µV/m)		-92 dB(µA/m)
100 MHz		-54 dB(µV/m)		
200 MHz		-48 dB(µV/m)	-49 dB(µV/m)	
300 MHz			-54 dB(µV/m)	
400 MHz			-48 dB(µV/m)	
500 MHz			-49 dB(µV/m)	
1000 MHz			-54 dB(µV/m)	

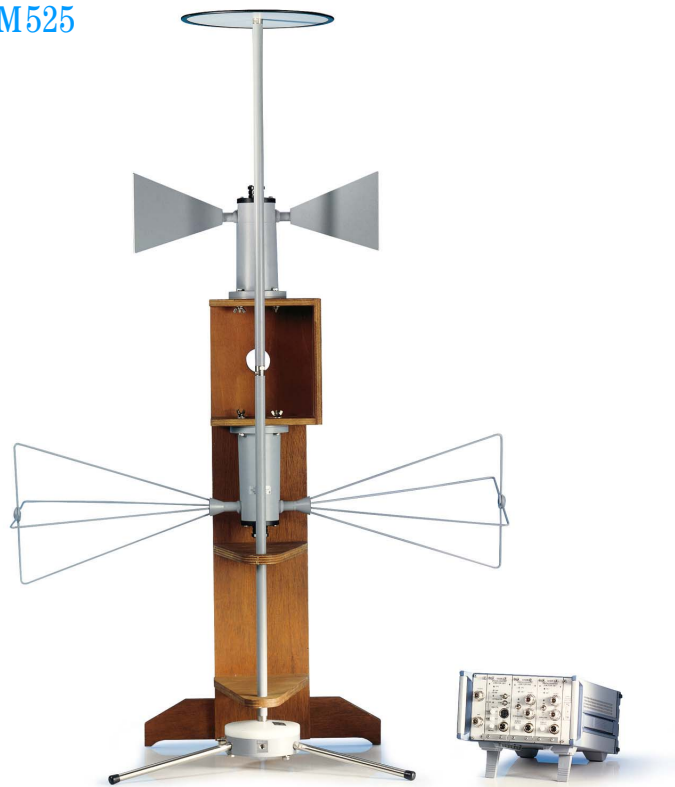

**R&S® AM524**



**R&S® HM525**

### Ordering information

<b>Active Antenna System</b>	R&S® AM524	4015.7001.02
consisting of		
Active Rod Antenna	R&S® HE525	4015.7101.02
Active Dipole Antenna	R&S® HE526	4015.7501.02
Active Dipole Antenna	R&S® HE527	4015.8008.02
Junction Unit for		
R&S® HE525	R&S® GX525	4015.9256.02
R&S® HE526	R&S® GX526	4015.9504.02
R&S® HE527	R&S® GX527	4015.9756.02
Basic Unit with power supply	R&S® KK524	4015.9004.02
Transit Case	R&S® ZR524K	4015.8508.02
Support for R&S® HE526 and HE527	R&S® AM524-Z1	4036.0506.02
<b>Active H-Field Test Antenna</b>	R&S® HM525	4031.0508.02
Support for H-Field Test Antenna	R&S® HM525-Z1	4036.1402.02
Control Unit	R&S® GS525	4035.5004.02



Contents Overview

Chapter Overview

Type Index

R&S Addresses





## Shielded, Calibrated Magnetic Field Pickup Coil R&S®HZ-10

5 Hz to 10 MHz

Measurement of magnetic field strengths to relevant standards

*R&S®HZ-10 with (right) and without (left) spacing plate*



### Brief description

The shielded and individually calibrated Magnetic Field Pickup Coil R&S®HZ-10 allows magnetic field strengths in the frequency range from 20 Hz to 200 kHz to be measured in line with commercial and military standards MIL-STD-461/462, DEF-STAN59-61, GAM-EG 13, VG95377 Part 13 and EN55103-1. These standards give limits for the magnetic flux density in the frequency range from 30 Hz to 50 kHz

or 200 kHz and prescribe an electrostatically shielded coil with a defined number of turns for measuring the magnetic flux density. The coil comes with a calibration certificate for the range from 5 Hz to 10 MHz.

### Main features

- ◆ Built to MIL-STD-461A and 462D
- ◆ Individually calibrated
- ◆ Shielded twin-wire connection

- ◆ Spacing plate 7 cm (MIL-STD-461, DEF-STAN59-41) and 5 cm (VG standard)
- ◆ Isolated coil with shielded twin-wire connection to avoid galvanic surface currents induced in the shielding
- ◆ 1/4" thread for mounting on a camera tripod

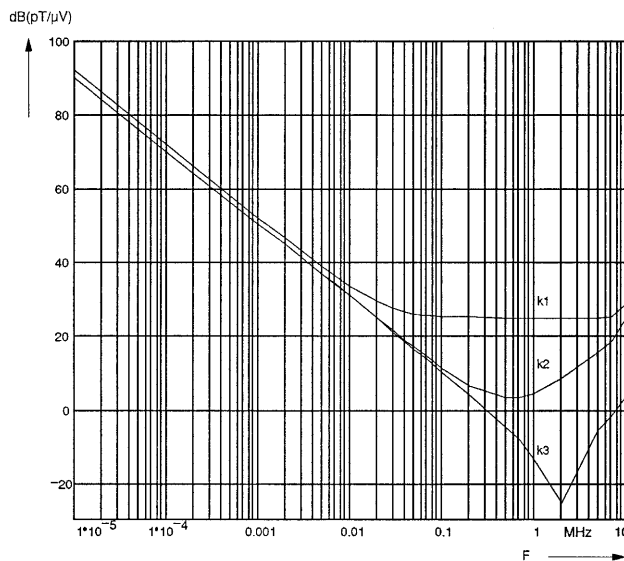

**Antenna factors in dB(pT/µV) measured and calculated by calibration: antenna factor k1 with 50 Ω, k2 with 600 Ω and k3 with 1 MΩ; k2 and k3 valid up to 100 kHz (above 100 kHz approximate values only)**

### Specifications in brief

Frequency range	5 Hz to 10 MHz
Antenna factor	see diagram (calibration certificate supplied with coil)
<b>Coil</b>	
Diameter	133 mm
Number of turns	36
Type of wire	7-41, litz wire
Resistance	10 Ω
Inductance	415 µH
Connector	Twinax female
Dimensions (W × H × D); weight	142 mm × 178 mm × 29 mm; 260 g

### Ordering information

<b>Shielded, Calibrated Magnetic Field Pickup Coil</b>	R&S®HZ-10	0816.2511.02
<b>Extras</b>		
RF Connecting Cable balanced/unbalanced, 0.2 m, Twinax/BNC connector	R&S®EZ-19	1052.2630.02



Contents Overview

Chapter Overview

Type Index

R&amp;S Addresses



## E and H Near-Field Probe Sets R&amp;S®HZ-11, R&amp;S®HZ-14

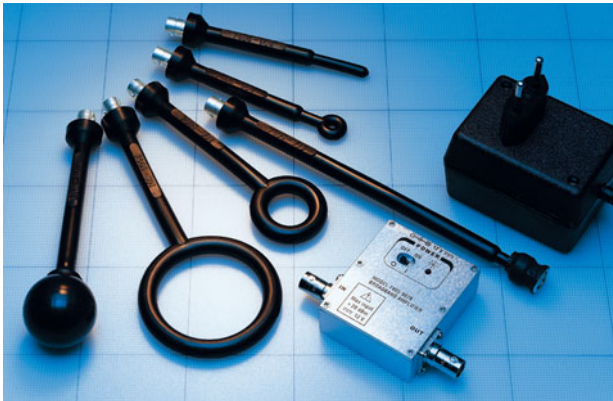

Probe Set R&amp;S®HZ-11



Probe Set R&amp;S®HZ-14

**R&S®HZ-11: 100 kHz to 2 GHz; R&S®HZ-14: 9 kHz to 1 GHz****Diagnostic tools for solving EMC problems****Brief description**

The near-field probe sets can be used in conjunction with test receivers, spectrum analyzers or oscilloscopes to determine electromagnetic emissions of any type. Their main application is in the diagnosis of emissions from printed circuit boards, cables and leakage spots in shielded enclosures. The passive probes can be used for a local susceptibility test.

Probe Set R&S®HZ-11 is for a qualitative, Probe Set R&S®HZ-14 for a quantitative analysis. The probe sets come in a handy transit case.

**Equipment supplied, characteristics****Probe Set R&S®HZ-11 comprises:**

- ◆ three passive H-field probes
- ◆ two passive E-field probes
- ◆ one probe extension and
- ◆ one preamplifier with built-in battery and battery charger

The H-field probes are small (diameter of 1 cm, 3 cm and 6 cm) electrically shielded loop antennas with directional pattern;

the E-field probes, shaped as rod and spherical probes, are for omnidirectional reception of the interference source.

**Probe Set R&S®HZ-14 comprises:**

- ◆ two passive H-field probes (9 kHz to 30 MHz and 30 MHz to 1 GHz)
- ◆ one active E-field probe (9 kHz to 1 GHz)
- ◆ one 30 dB preamplifier for the H-field probe (can be powered from all Rohde&Schwarz test receivers and spectrum analyzers)
- ◆ a test jig for testing the H-field probes and simplified normalization of H-field measurements with the aid of a tracking generator and normalization functions provided in spectrum analyzers



Contents Overview

Chapter Overview

Type Index

R&amp;S Addresses





Contents Overview

Chapter Overview

Type Index

R&amp;S Addresses



## E and H Near-Field Probe Sets R&amp;S®HZ-11, R&amp;S®HZ-14

## Specifications in brief

## R&amp;S®HZ-11

Type of probe	Measurement of	E- or H-field rejection	1st resonant frequency		
Loop 6 cm	H-field	41 dB	790 MHz		
Loop 3 cm	H-field	29 dB	1.5 GHz		
Loop 1 cm	H-field	11 dB	2.3 GHz		
Sphere 3.6 cm	E-field	30 dB	>1 GHz		
Rod 6 mm	E-field	30 dB	>2 GHz		
Gain of broadband preamplifier					
100 kHz	1 MHz	100 MHz	1 GHz	2 GHz	3 GHz
35 dB	38 dB	39 dB	33 dB	26 dB	14 dB
Noise figure at 500 MHz		typ. 3.5 dB			
Saturated output level at 100 MHz		typ. 12 dBm			
1 dB compression point at 100 MHz		typ. 8 dBm			

## R&amp;S®HZ-14 (9 kHz to 1 GHz)

H-field probe, max. input power	≤30 MHz: 0.5 W, >30 MHz: 0.25 W
VSWR (f >30 MHz)	<2
E-field probe	
Frequency response	3 dB
Sensitivity	13 mV/V
Connectors	SMA female
Preamplifier	9 kHz to 1 GHz
Gain	30 ±2 dB (typ. 1 dB)
Input/output	BNC female/N male
Impedance, VSWR	50 Ω, <2
Powering	10 V ±0.1 V, <100 mA
DC connector	LEMO

## Ordering information

E and H Near-Field Probe Set		
with power supply 220 V	R&S®HZ-11	0816.2770.04
with power supply 110 V	R&S®HZ-11	0816.2770.05
E and H Near-Field Probe Set		
	R&S®HZ-14	1026.7744.02



Contents Overview

Chapter Overview

Type Index

R&amp;S Addresses



## Precision Halfwave Dipole Sets R&S® HZ-12, R&S® HZ-13



R&S® HZ-13



R&S® HZ-12

**R&S® HZ-12: 30 MHz to 300 MHz**

**R&S® HZ-13: 300 MHz to 1 GHz**

**Test standards for antenna calibration and test-site attenuation measurements**

### Brief description

#### Antenna calibration

Tunable halfwave dipoles are used for the calibration of VHF-UHF broadband antennas, which have their advantages in practical use but whose characteristics cannot be strictly calculated.

#### Test-site attenuation measurements

Halfwave dipoles are the only tool for checking reference sites used for antenna calibration to ANSI C63.5. They are also used for checking anechoic chamber test sites.

#### Characteristics

The dipoles contain balance-to-unbalance transformers and attenuators. The attenuation between the dipole connectors and the 50 Ω connector is about 10 dB. Two closely linked dipoles provide an attenuation of about 20 dB. This value can be very accurately measured with a network analyzer. The sum of the two antenna factors  $2k_e$  (it is only the sum that is of significance for the test-site validation) can thus be precisely calculated:

$$2k_e = 20 \text{ dB} + 2 \times 1.64 \text{ dB} + 2 \times 20 \log(2\pi/\lambda) \text{ dB}$$

1.64 dB = voltage transformation  
 $2\pi/\lambda$  = antenna factor of  $\lambda/2$  dipole

#### Equipment supplied

Each dipole set comes in a transit case to protect the dipole rods. The dipole supports are fitted with flanges suitable for mounting on Rohde&Schwarz antenna masts. The manual supplied with the dipole sets contains the attenuation values of the dipole set and a table for height-dependent correction of the antenna factors above a conductive ground plane.

### Specifications in brief

Frequency range	
R&S® HZ-12	30 MHz to 300 MHz
R&S® HZ-13	300 MHz to 1000 MHz
Power attenuation of dipole pair (closely coupled)	20 dB (calibration curve supplied with set)

Antenna factor	
R&S® HZ-12	7.5 dB to 27.6 dB (proportional to f)
R&S® HZ-13	27.4 dB to 38 dB (proportional to f)

### Ordering information

Precision Halfwave Dipole Set	R&S® HZ-12	0816.2870.02
	R&S® HZ-13	0816.2940.02

## Active Receiving Dipoles R&S®HE202, R&S®HE302



R&S®HE302



R&S®HE202

### Brief description

Despite their extremely large bandwidth, R&S®HE202 and R&S®HE302 feature a field-strength sensitivity that is in the entire frequency range comparable to that of antennas with smaller bandwidth and considerably larger dimensions.

The degree of nonlinear distortion in the test system is important for signal field strength and interference field-strength

measurements in shielded rooms. With 1-dB compression, for example, the Active Receiving Dipole R&S®HE302 is in the linear range for field strengths up to 5 V/m at 20 MHz and up to 8 V/m at 500 MHz. At frequencies below 20 MHz the maximum field strength increases by 40 dB per decade thanks to the reactive components in the input circuit.

### Main features

- ◆ Extremely small size
- ◆ High sensitivity
- ◆ Wide frequency range
- ◆ High immunity to nonlinear distortion, comparable to passive antennas in conjunction with high-grade preamplifier
- ◆ High immunity to nearby lightning strikes
- ◆ Shock- and vibration-resistant

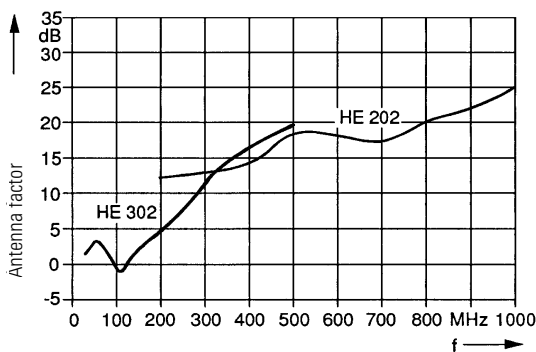

Antenna factor as a function of frequency

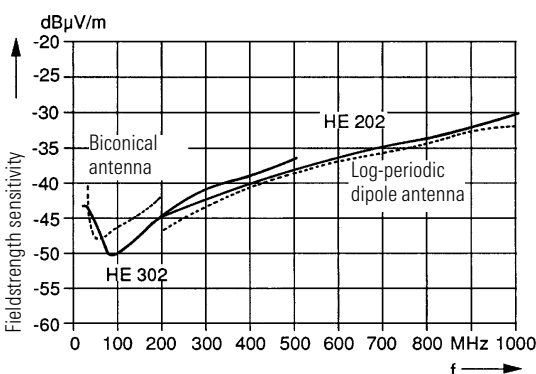

Field-strength sensitivity of R&S®HE202, R&S®HE302 compared to that of passive antennas with a receiver noise figure of 10 dB

### Specifications in brief

	R&S®HE202	R&S®HE302
Frequency range	200 to 1000 MHz	20 to 500 MHz
Polarization	linear	linear
Connector	N female, 50 Ω	N female, 50 Ω
VSWR	<2.5	<2.5
Electronic gain	5 dB to 9 dB	-11 dB to +8 dB
Practical gain	7 dB to 11 dB	-9 dB to +10 dB
Directivity	2 dB average	2 dB average
Antenna factor and field-strength sensitivity	see diagrams	see diagrams
Noise figure	200 MHz: 6 dB 1000 MHz: 7 dB	20 MHz: 28 dB 500 MHz: 9 dB
Intercept point	2nd order 3rd order	>55 dBm >30 dBm
Power supply (from Power Supply Unit R&S®IN115), DC voltage	18 V to 30 V, via RF cable 200 mA	170 mA
Dimensions (L × H)	512 mm × 238 mm	1 m × 240 mm
Weight	2.1 kg	2.5 kg

### Ordering information

Active Receiving Dipoles	R&S®HE202	R&S®HE302
	0630.0310.0x	0644.1114.0x
(x = 2: for monitoring; x = 3: calibrated to ANSI C63.5)		
Extras		
Mast Adapter	R&S®HE202 Z1	0649.7510.02
RF Cable	R&S®HE202 Z2	0649.7785.02
Antenna Adapter	R&S®AM524Z2	4036.0658.02
Calibration at Delivery	R&S®HE202, R&S®HE302	0758.3109.23

## HF Antennas

### Loop Antenna R&S®HFH2-Z2

Broadband active loop antenna for measuring the magnetic field-strength components



### Inductive Probe R&S®HFH2-Z4

Inductive probe for the assessment of the magnetic field-strength components



### Power Supply R&S®HZ-9



Power supply for feeding the active Antennas R&S®HFH2-Z1/Z2/Z6 if these antennas cannot be powered from the test receiver

### Rod Antenna R&S®HFH2-Z6

Broadband active rod antenna for measuring the electrical component of radiated EMI in test setups to MIL-STD-461/462 and similar MIL standards

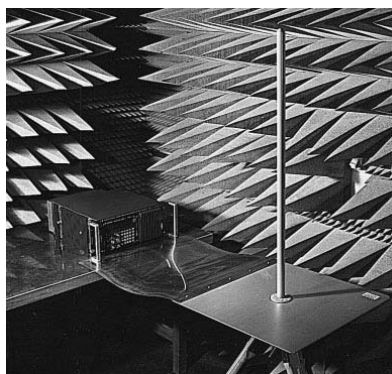

### Specifications in brief R&S®HZ-9

Output voltages	±10 V ±0.5 %
Min. current load	100 mA
DC connector	12-contact Tuchel female
AC supply	100 V to 240 V, -15/+10%
Dimensions (W × H × D)	125 mm × 70 mm × 188 mm
Weight	1.5 kg

### Ordering information R&S®HZ-9

<b>Power Supply for</b>	
Active Antennas R&S®HZ-9	0816.1015.02

### Specifications in brief

	Loop Antenna R&S®HFH2-Z2	Inductive Probe R&S®HFH2-Z4	Rod Antenna R&S®HFH2-Z6
Frequency range	9 kHz to 30 MHz	100 kHz to 30 MHz	9 kHz to 30 MHz
Antenna factor k, referred to 1/m	20 dB (E field)	80 dB (E field)	10/20 dB, selectable
Accuracy	1 dB	6 dB	1 dB
Measurement range (IF bandwidth 200 Hz, AV ind.)			
Lower limit, frequency-dependent	9 kHz to 1 MHz: +40 to +10 dB(μV/m) 1 MHz to 30 MHz: +10 to +5 dB(μV/m)	50 dB(μV/m) (≈0 dB(μA/m))	+15 to -18 dB(μV/m)
Upper limit	140 dB(μV/m)	>190 dB(μV/m) (≈140 dB(μA/m))	140 dB(μV/m) 130 dB(μV/m) (k=10 dB)
Connectors			
RF	BNC female, 50 Ω	BNC male, 50 Ω	BNC female, 50 Ω
Supply and coding (antenna factor)	12-contact Tuchel female	12-contact Tuchel male	12-contact Tuchel female
Length of connecting cables	10 m	1 m	10 m
Current drain (±10 V)	<40 mA	—	<45 mA
Dimensions	loop dia.: 590 mm	outer dia.: 50 mm, height: 20 mm	base: 60 mm × 60 mm, rod height: 1000 mm
Weight	in transit case, without cable: 12 kg	with cable: 0.3 kg	without cable: 5 kg
Order No.	0335.4711.52	0338.3016.52	0837.1866.54

## VHF, UHF and SHF Antennas

### Biconical Antenna R&S® HK 116,

### Log Periodic Antennas

### R&S® HL223, R&S® HL023A1,

### R&S® HL040 and R&S® HL050,

### High-gain Log. Periodic Antenna

### R&S® HL046

### Brief description

These linearly polarized antennas are used for EMI and EMS measurements in line with commercial and military standards. Depending on frequency and type of antenna, maximum field-strength values between 10 V/m and 300 V/m can be achieved. The use of Conical Log Spiral Antenna R&S® HUF-Z4 with circular polarization is limited to measurements in line with MIL-STD-461 A to C.



R&S® HUF-Z4



R&S® HL050

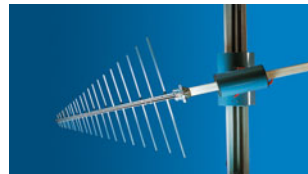

R&S® HL223  
(R&S® HL023A1 on page 98)

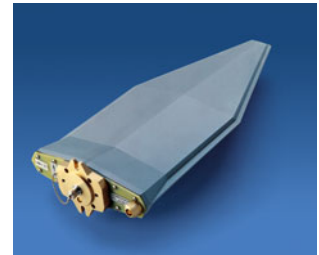

R&S® HL040



R&S® HL046 with option  
R&S® HL046-P

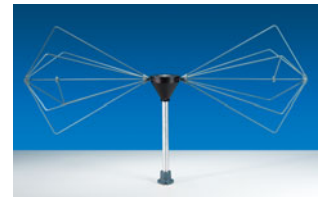

R&S® HK 116

### Specifications in brief

	R&S® HK 116	R&S® HL223	R&S® HL023 A1	R&S® HL040	R&S® HL050	R&S® HUF-Z4
Frequency range	20 MHz to 300 MHz	0.2 GHz to 1.3 GHz	0.08 GHz to 1.3 GHz	0.4 GHz to 3 GHz	0.85 to 26.5 GHz	0.2 GHz to 1 GHz
Antenna factor k	21 dB to 8 dB	10 dB to 26 dB	4 dB to 25 dB	17 dB to 33 dB	20 dB to 50 dB	17.5 to 27 dB
Power-handling capacity	70 W	1500 W to 600 W	700 W to 230 W	50 W	10 W to 2 W	100 W
Max. field strength for distance 1 m	10 to 60 to 20 V/m	280 V/m	110 V/m to 180 V/m	50 V/m to 100 V/m	40 V/m to 20 V/m	10 V/m to 50 V/m
VSWR	typ. 2.5	typ. 1.6 (<2)	typ. 2 (<2.5)	typ. 2 (<2.5)	<2.5	<3
Connector/nominal impedance	N female/50 Ω	N female/50 Ω	N female/50 Ω	N female/50 Ω	SMA female	N female/50 Ω
Weight	3 kg	2 kg	7.7 kg	2.8 kg	0.7 kg	7.7 kg
Order No.	4000.7752.02	4001.5501.02	0577.8017.02	4035.8755.02	4062.4063.02	0837.2210.52

### Specifications in brief R&S® HL046

Frequency range	80 MHz to 1300 MHz
Polarization	linear
Polarization isolation	typ. 20 dB
Front-to-back ratio	typ. >20 dB
VSWR	<2
Max. input power (T <sub>amb</sub> = +40 °C)	
80 MHz	1000 W + 100% AM
500 MHz	500 W + 100% AM
1000 MHz	300 W + 100% AM
1300 MHz	250 W + 100% AM
Gain	>7 dBi

RF connector	N female, 50 Ω
Dimensions (W × H × L)	
without trolley (in m)	0.85 × 1.57 × 1.75
with trolley (in m)	0.86 × 1.9 (variable up to 2.6 m) × 1.85
Weight without/with trolley	12.5 kg/22.5 kg

### Ordering information R&S® HL046

High-gain Log. Per. Antenna	R&S® HL046	4040.8708.02
<b>Extras</b>		
Pneumatic Control	R&S® HL046-P	4053.1694.02
Pedestal, movable	R&S® HL046Z1	4061.0106.02

## ULTRALOG R&S® HL562

**30 MHz to 3000 MHz**

**EMI and EMS measurements  
in an extremely wide frequency  
range**

### Brief description

The ULTRALOG antenna combines the characteristics of a biconical and a log-periodic antenna. The ULTRALOG antenna is mainly used for measuring emissions in the broad frequency range from 30 MHz to 3 GHz without change of the antenna. Symmetry and matching (VSWR) of the ULTRALOG allow its use in EMS measurements where field strengths of 10 V/m or higher are required.



*R&S® HL562 with option R&S® HL562Z1*

The log-periodic part of the antenna is V-shaped in order to increase the system sensitivity in particular from 500 MHz to 1 GHz. Unlike with conventional designs, this gain-increasing measure brings about the compact size of the ULTRALOG.

### Special features

- ◆ Only one antenna required to cover wide frequency range
- ◆ Selectable polarization plane
- ◆ Suitable for EMS measurements with high field strengths
- ◆ Gain increase at high frequencies
- ◆ Compact size
- ◆ Individual calibration (ANSIC63.5 and DIN 45003)

### Specifications

Frequency range	30 MHz to 3000 MHz
Polarization	linear
Polarization isolation	>20 dB (acc. to CISPR 16-1)
Nominal impedance	50 Ω
VSWR	typ. <2
Max. input power (T <sub>amb</sub> = +40 °C)	
30 MHz	150 W + 100% AM
80 MHz	300 W + 100% AM
250 MHz	500 W + 100% AM
1000 MHz	280 W + 100% AM
3000 MHz	180 W + 100% AM

Frequency range	30 MHz to 3000 MHz
Gain	typ. 8 dBi from 200 MHz
RF connector	N female
Class of application	laboratory
Dimensions (W × H × L)	approx. 0.60 m × 1.65 m × 1.68 m
Weight	approx. 5 kg

### Ordering information

<b>ULTRALOG</b>	R&S® HL562	4041.3000.02
<b>Extra</b>		
Tripod, movable	R&S® HL562Z1	4041.3900.02



## Double-Ridged Waveguide Horn Antenna R&S® HF906

1 GHz to 18 GHz

Broadband directional antenna,  
preferably for use in EMI measurements

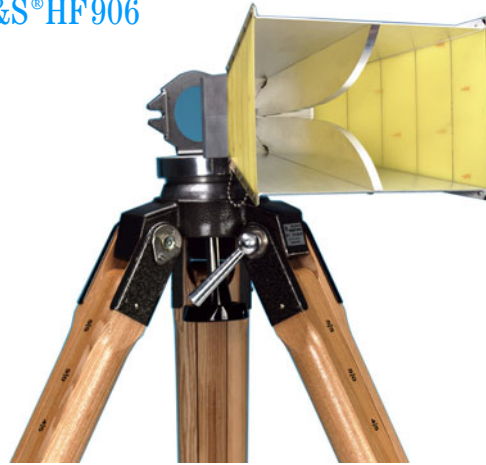

R&S® HF906 with optional  
Wooden Tripod R&S® HZ-1

### Brief description

The Double-Ridged Waveguide Horn Antenna R&S® HF906 with linear polarization is a broadband compact transmitting and receiving antenna for the frequency range from 1 GHz to 18 GHz. The calibrated antenna is ideal for use in EMI measurements. High gain and low VSWR allow the generation of high field-

strength levels without any significant return loss as well as the measurement of weak signals. The principle of the exponential double-ridged waveguide makes for the wide frequency range from 1 GHz to 18 GHz of the Antenna R&S® HF906 despite its small dimensions. The gain increases with the frequency. The horn antenna requires little space and is easy to handle. The use of an N connector

allows easy adaptation to existing units as well as high input power. The antenna is made of aluminium and tinned GRP boards to keep its weight low.

### Main features

- ◆ Wide frequency range
- ◆ High gain
- ◆ Input power up to 300 CW/500 W PEP

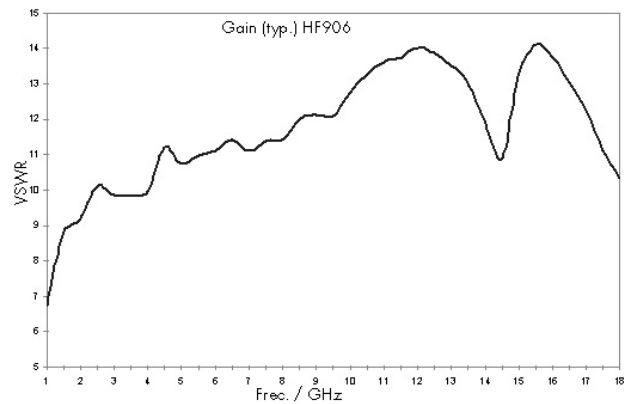
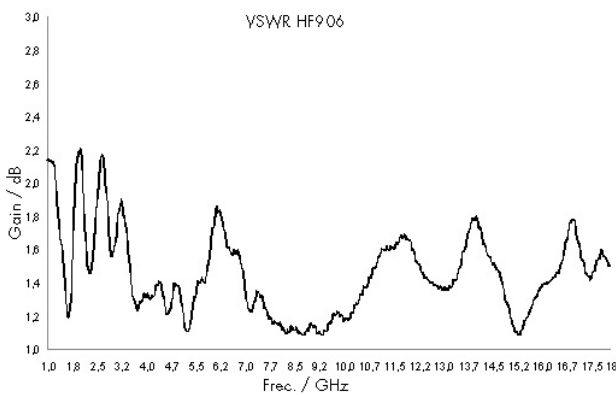

### Specifications

Frequency range	1 GHz to 18 GHz
Polarization	linear
Nominal impedance	50 Ω
VSWR	typ. <1.5
Max. input power	300 W CW/500 PEP
Gain	typ. 7 dB to 14 dB (see diagram)
Connector	N female
Operating temperature	0°C to +50°C
Dimensions (L × W × H)	290 mm × 250 mm × 160 mm
Weight	1.5 kg

### Ordering information

<b>Double-Ridged Waveguide Horn Antenna</b>	R&S® HF906	4044.4507.02
<b>Extra</b>		
Wooden Tripod	R&S® HZ-1	0837.2310.02



Contents Overview

Chapter Overview

Type Index

R&amp;S Addresses



## Broadband Dipole R&S® HUF-Z1

The antenna complies with CISPR 16-1. The antenna factor  $k$  is nearly constant in the range 25 MHz to 80 MHz; a factor of 15 dB or 20 dB can be selected.

### Specifications in brief

Frequency range	20 MHz to 80 MHz
Connector	N female
Nominal impedance	50 $\Omega$
VSWR	
for $k = 15$ dB	<2
for $k = 20$ dB	<1.3
Antenna factor $k$	
for $k = 15$ dB	
20 MHz to 25 MHz	22.5 dB to 15 dB
25 MHz to 80 MHz	15 dB
for $k = 20$ dB	
20 MHz to 25 MHz	27.5 dB to 20 dB
25 MHz to 80 MHz	20 dB
Dipole length	1.77 m
Folded size	0.9 m $\times$ 0.13 m dia.
Weight	2.5 kg



R&amp;S® HUF-Z1

### Ordering information

Broadband Dipole	R&S® HUF-Z1	0358.0512.52

## Mast and Tripod R&S® HFU-Z

### Brief description

The mast consists of three epoxy glass laminate tubes, a swivel arm holder and an antenna carrier. Guy ropes and pegs are supplied with the mast. The receiving antenna can be positioned at a height between 1 m and 5 m. Azimuth and polarization plane can be chosen as desired; the elevation angle can be varied by a maximum of  $\pm 30^\circ$ .

### Specifications in brief

Dimensions (folded)	
Mast	length: 1.65 m
Tripod	length: 0.9 m dia.: 0.22 m
Transport weight	
Mast	36 kg (with crate)
Tripod	9 kg

### Ordering information

<b>Mast</b>	R&S® HFU-Z	0100.1120.02
<b>Tripod</b>	R&S® HFU-Z	0100.1114.02

## Wooden Tripod R&S® HZ-1

### Brief description

This tripod supports the Antennas R&S® HFH 2-Z6, R&S® HK116, R&S® HL223 and R&S® HUF-Z4.

- ◆ Light-metal universal ball joint tiltable all round up to  $25^\circ$ ; lockable in any position
- ◆ Antenna holder with captive  $\frac{1}{4}$ " screw
- ◆ Each two-section tripod leg extensible between 830 mm and 1360 mm

### Specifications in brief

Length, collapsed	910 mm
Weight	6.5 kg

### Ordering information

<b>Wooden Tripod</b>	R&S® HZ-1	0837.2310.02
----------------------	-----------	--------------



Mast and Tripod R&amp;S® HFU-Z with Antenna R&amp;S® HL023A1



Contents Overview

Chapter Overview

Type Index

R&amp;S Addresses





Contents Overview

Chapter Overview

Type Index

R&amp;S Addresses



## V-Networks R&amp;S® ESH2-Z5, R&amp;S® ESH3-Z6

Interference measurements on

AC-powered loads: R&amp;S® ESH 2-Z5

for remote-control via

Rohde&amp;Schwarz EMI test

receivers, insertion loss calibrated

to ANSIC63.4



R&amp;S® ESH2-Z5



R&amp;S® ESH3-Z6

## Main features

- ◆ AC voltage supply to EUT
- ◆ Isolation of test circuit from line interference
- ◆ Standardized load impedance
- ◆ Defined feed of interference voltage produced by EUT to EMI test receiver

## R&amp;S® ESH 2-Z5

Four-line V-network (50  $\mu\text{H}$  + 5  $\Omega$ ) shunted by 50  $\Omega$  in line with VDE0876 and CISPR 16-1. It uses air-core inductances and contains an artificial hand as well as a PE simulating network that can be bypassed. A built-in fan with its own AC supply provides automatically controlled or permanent cooling, as required.

## R&amp;S® ESH3-Z6

R&S® ESH3-Z6 is a single-phase V-network (5  $\mu\text{H}$  + 1  $\Omega$ ) shunted by 50  $\Omega$  complying with the requirements of VDE 0876 Part 1 (onboard power supply systems), CISPR Publ. 16 (low-impedance power supplies) as well as MIL-STD-462 Notice 3, MIL-I-6181D, MIL-I-16910C, MIL-E-55301, DEF-STAN 59-41 and DO 160 in the frequency range 100 kHz to 200 MHz.

## Specifications in brief

	R&S® ESH2-Z5	R&S® ESH3-Z6
Frequency range	9 kHz to 30 MHz	0.1 MHz to 200 MHz
Impedance accuracy	$\pm 20\%$	$\pm 20\%$
Continuous current	4 $\times$ 25 A	100 A (150 A to $T_{\text{amb}} = 35^\circ\text{C}$ )
Max. short-time current	4 $\times$ 50 A (2 min)	500 A (30 s)
Max. AC supply voltage	250 V rms	250 V rms; 600 V DC
Max. AC supply frequency	63 Hz	440 Hz
AC supply input connector	4 $\times$ 32 A (Cekon male) European male for fan	screw terminal M8
AC supply connector for EUT	4 $\times$ 32 A (Cekon female) 2 $\times$ 16 A (earthing-contact, female)	screw terminal M8, reference ground to metallic ground plate
RF output to test receiver	BNC female	N male
Remote-control input from test receiver	50-contact Amphenol female	–
Input for artificial hand	two 4 mm jacks	–
Dimensions (H $\times$ W $\times$ D)	492 mm $\times$ 294 mm $\times$ 603 mm	122 mm $\times$ 128 mm $\times$ 322 mm
Weight	26 kg	1.9 kg

## Ordering information

V-Network	0338.5219.53	0836.5016.52
<b>Extras</b>		
Control cable to test receiver		
R&S® ESxl/ESlx	R&S® EZ-5 (0816.0625.02) (10 m)	–
R&S® ESCS/ESPI	R&S® EZ-13 (1026.5293.02)	–



Contents Overview

Chapter Overview

Type Index

R&amp;S Addresses





Contents Overview

Chapter Overview

Type Index

R&amp;S Addresses



## Two-Line V-Network R&amp;S®ENV216

## RFI voltage measurements on single-phase EUTs

## Brief description

The Two-Line V-Network R&S®ENV216 ( $50 \mu\text{H} + 5 \Omega$ )/ $50 \Omega$  satisfies the requirements of VDE0876 and CISPR Publ. 16-1 for V-networks (incl. the requirements of the planned extension for CISPR/A/413/CD regarding the isolation between EUT and power port and the impedance with respect to magnitude and phase) in the frequency range 9 kHz to 30 MHz. It is based on air-core inductances and contains an artificial hand.

## Main features

- ◆ V-network to CISPR, EN, VDE, ANSI and MIL-STD-461 D and E; meets CISPR/A/413/CD
- ◆ Calibrated to CISPR 16-1:1999 and ANSIC63.4
- ◆ Frequency range 9 kHz to 30 MHz

## Specifications in brief

Frequency range	9 kHz to 30 MHz
Impedance characteristic of V-network to CISPR 16-1:1999	$(50 \mu\text{H} + 5 \Omega)/50 \Omega$
Error limits (to CISPR 16-1)	
Impedance magnitude	$\pm 20\%$
Phase	$\pm 11.5^\circ$
Max. permissible constant current for plug and socket (dependent on country)	
Model .02, .04	16 A
Model .03	13 A
Model .05, .06	15 A
Max. permissible AC supply voltage against reference ground	$V_{\text{rms}} = 255 \text{ V}$
Max. permissible DC voltage against reference ground	$V_{\text{DC}} = 50 \text{ V}$
Max. permissible RFI (from EUT)	1 W
Highpass filter (integrated, switch-selectable)	150 kHz
Attenuator (built-in)	10 dB
Response threshold of built-in pulse limiter (output level)	140 dB( $\mu\text{V}$ )
AC supply frequency	0 Hz to 63 Hz
<b>Connectors</b>	
AC supply voltage input	plug with earthing contact and 1.8 m cable (country-specific models)
AC supply voltage input for EUT	socket with earthing contact (country-specific models)
RF output	N connector, female, $50 \Omega$
Remote control input	25-contact Sub-D connector, female



- ◆ Power-handling capacity 16 A, constant current
- ◆ 150 kHz highpass filter, switch-selectable
- ◆ Built-in 10 dB attenuator and pulse limiter
- ◆ Highpass switch and phase select remote controllable with Rohde&Schwarz test receivers
- ◆ Range of models with country specific plug systems
- ◆ Compact, low weight

Input for artificial hand	4 mm connector, female, with knurled clamp
Reference ground connection	ground bar with 3 M4 threads
Protective earth connection	threaded bolt with wing nut
Connector for external power supply	DC hollow connector, 5.5/2.1 mm dia., 10 V to 18 V DC, 250 mA (met by supplied plug-in power supply)
<b>General data</b>	
Operating temperature range	0°C to +45°C
Storage temperature range	-25°C to +70°C
Dimensions (W × H × D)	219 mm × 147 mm × 350 mm

## Ordering information

Two-Line V-Network	R&S®ENV216	3560.6550.yy
Germany (earthing-type connector)		yy = 02
United Kingdom		yy = 03
France		yy = 04
China, Australia		yy = 05
USA		yy = 06

## Accessories supplied

Manual, calibration record, plug-in power supply (country-specific)

## Extras

Remote control cable, 25-contact (Control by receiver of R&S®ESxS, R&S®ESIBx, R&S®ESPlx series connector/connector, 1:1 wiring; two cables required for shielded rooms)		
Control Cable, 3 m	R&S®EZ-21	1107.2087.03
Control Cable, 10 m	R&S®EZ-21	1107.2087.10



Contents Overview

Chapter Overview

Type Index

R&amp;S Addresses



## 200-A Four-Line V-Network R&amp;S® ENV4200

## 150 kHz to 30 MHz

For RFI voltage measurements at high currents

## Brief description

Four-Line V-Network R&S® ENV4200 is used for measuring RFI voltages on AC supply connections of EUTs carrying very high currents.

It uses air-core inductances and contains an artificial hand. R&S® ENV4200 satisfies the requirements of CISPR 16-1, VDE0876 and ANSI C63.4 for V-networks with an impedance of  $50 \mu\text{H} \parallel 50 \Omega$  in the frequency range 150 kHz to 30 MHz.

CISPR 16-1 specifies two types of V-networks for the frequency range 150 kHz to 30 MHz: one with an impedance of  $50 \mu\text{H} \parallel 50 \Omega$  and another with an impedance of  $(50 \mu\text{H} + 5 \text{ W}) \parallel 50 \Omega$ . V-Network R&S® ENV4200 corresponds to type 1.

## Specifications in brief

<b>Frequency range</b>	150 kHz to 30 MHz
<b>Impedance characteristic of V-network</b>	$50 \mu\text{H} \parallel 50 \Omega$
<b>Error limits (to CISPR 16-1)</b>	$\pm 20\%$
<b>Test path (to EUT)</b>	
<b>Max. permissible continuous current</b>	4 × 100 A with fans switched off 4 × 200 A with fans switched on
<b>Operating time derated</b>	at higher currents
<b>DC resistance per path</b>	typ. 6.7 mΩ
<b>AC supply frequency range</b>	0 Hz to 63 Hz
<b>Max. permissible AC supply voltage</b>	260 V/450 V
<b>Test path (to test receiver)</b>	
<b>Pulse limiter</b>	to 150 dBμV (built-in)
<b>Voltage attenuation between EUT and test receiver</b>	10 dB (built-in attenuator pad)
<b>Cooling</b>	with 4 built-in fans
<b>Connectors</b>	
<b>EUT connectors</b>	knob for 15 mm terminals
<b>Ground</b>	screw terminal M8
<b>Reference ground</b>	uninsulated busbars
<b>RF connector</b>	BNC female
<b>Remote control</b>	25-pin Cannon female



The maximum attainable current of the V-network is limited by the voltage drop at the standardized inductances (CISPR 16-1 prescribes the voltage drop at 5% of the AC supply voltage) and by unavoidable heat losses.

## Main features

- ◆ V-network to CISPR, EN, VDE, ANSI
- ◆ Impedance  $50 \mu\text{H} \parallel 50 \Omega$
- ◆ Artificial hand
- ◆ Continuous current up to  $4 \times 200 \text{ A}$
- ◆ Air-core design
- ◆ Remote control with TTL levels
- ◆ Calibrated to CISPR/A/201/CDV and ANSI C63.4

General data	
Rated temperature range	+5°C to +40°C
Storage temperature range	-30°C to +70°C
Dimensions (W × H × D); weight	450 mm × 315 mm × 670 mm; 43 kg

## Ordering information

<b>Four-Line V-Network</b>	R&S® ENV4200	1107.2387.02
<b>Extras</b>		
25-wire remote control cable for control by Test Receivers of		
R&S® ESxS Series:		
Control Cable 3 m	R&S® EZ-21	1107.2087.03
Control Cable 10 m	R&S® EZ-21	1107.2087.10
(2 required for shielded room)		
R&S® EBxI Series:		
Control Cable 3 m	R&S® EZ-22	1107.2235.03
(Combination with R&S® EZ-21 required for shielded chamber)		

## Coupling Networks R&S®ENY

for EMI emission and immunity tests on unshielded symmetrical telecommunication ports

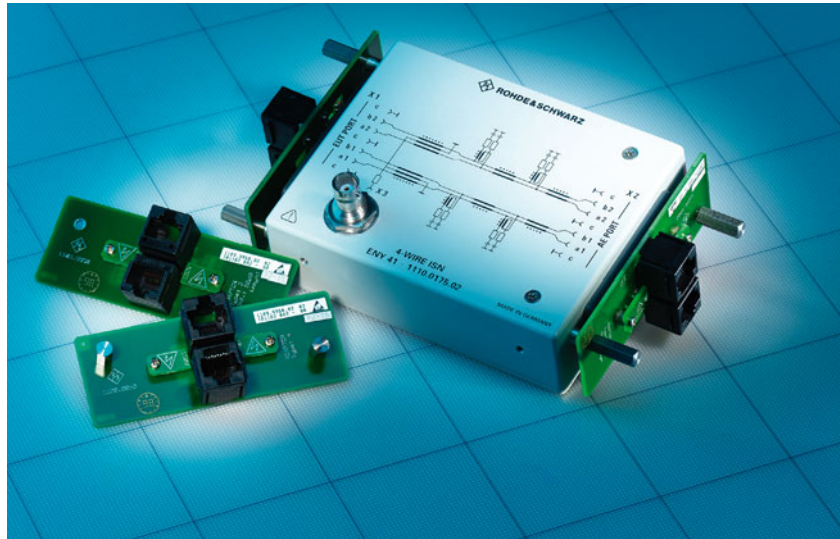

### Brief description

Coupling Networks R&S®ENY22 and R&S®ENY41 have been designed to measure the asymmetrical (common-mode) RFI voltage of unshielded symmetrical telecommunication ports of EUTs in the frequency range 150 kHz to 30 MHz according to CISPR 22, 1997/EN 55022, 1998.

In these product standards, this type of coupling networks is referred to as ISN (impedance stabilization network), whereas in basic standards they are called AAN (asymmetrical artificial network) or Y-network (CISPR 16) or CDN (coupling/decoupling network, IEC 61000-4-6).

In addition to emission measurements, R&S®ENY22 and R&S®ENY41 also enable immunity testing of the above-mentioned EUTs in the frequency range 150 kHz to 80 MHz according to CISPR 24, 1997/EN 55024, 1998 and IEC 61000-4-6. They meet the requirements of CISPR 22/1997.

*The table gives an overview of available RJ45 adapter sets. The four types I through IV are available for the four-wire ISN R&S®ENY41. For the double two-wire ISN, type V is available. For the latter, pins 3, 4 and 5, 6 are connected in parallel. In addition, there is an adapter set for user-selectable wiring (type VI).*

### Main features

- ◆ Four-wire and double two-wire networks (ISNs)
- ◆ Conducted emission measurements to CISPR 22/1997 and EN 55022/1998 (150 kHz to 30 MHz)
- ◆ Conducted immunity measurements to CISPR 24 and EN 55024 (150 kHz to 80 MHz)
- ◆ Adapter sets to meet LCL requirements (LCL: 50 dB, 60 dB and 80 dB) and various telecommunication standards
- ◆ High transfer bandwidth for useful signal (100 MHz)

Interface standard	Usual connectors	Pin configuration of RJ45 connector								Type
		8	7	6	5	4	3	2	1	
	RJ45									
	RJ11		6	5	4	3	2	1		
Deutsche Telekom	X			a	W	E	b			I
Deutsche Telekom V <sub>PN</sub> , V <sub>PO/E</sub>	X			a			b			V
Siemens	X			E	b	a	W			I
Siemens V <sub>PN</sub> , V <sub>PO/E</sub>	X				b	a				V
US standard	X			W	b	a	E			I
Token Ring	X			RX	TX	TX	RX			I
10Base T	X			RX			RX	TX	TX	II
100Base T	X			RX			RX	TX	TX	II
ATM	X	X	X					X	X	III
FDDI	X	X	X					X	X	III
ISDN basic rate access	X			X	X	X	X			I
ISDN primary rate access 2048 kbit/s	X				X	X		X	X	IV
ISDN primary rate access 1544 kbit/s	X				X	X		X	X	IV

## Coupling Networks R&amp;S®ENY

## Description

R&S®ENY22 comprises two separate two-wire networks with two receiver ports in one box, whereas R&S®ENY41 includes one four-wire network.

R&S®ENY22 and R&S®ENY41 terminate the interface of the EUT with 150 Ω (asymmetrical or common-mode impedance) and couple the asymmetrical impedance to the test receiver with a voltage-division factor of approx. 10 dB. The useful symmetrical (differential-mode) signal passes through the network almost unattenuated with a bandwidth of up to 100 MHz (measured for a symmetrical impedance of 100 Ω). At the same time the coupling network decouples the test circuit from interference effects (RFI voltage, impedance) at the AE (auxiliary equipment) port.



ISN Functional Test Set R&S®ENYBS incl. 2 baluns R&S®ENYB21 and one Set of ISN test boards

## Specifications

<b>Frequency range</b>	
Emission measurements	150 kHz to 30 MHz
Immunity measurements	150 kHz to 80 MHz
<b>Asymmetrical impedance</b>	
Impedance in range 0.15 MHz to 30 MHz	150 Ω ± 20 Ω
Phase angle in range 0.15 MHz to 30 MHz	0 ± 20°
Impedance in range 150 kHz to 80 MHz	150 Ω ± 40 Ω
<b>Voltage-division factor</b>	
In asymm. circuit in range 150 kHz to 30 MHz	10 dB ± 1 dB typ. (calibration data supplied <sup>1)</sup> )
<b>Transfer bandwidth (3 dB)</b>	
In symm. circuit	>100 MHz (for 100 Ω source and load impedances)
<b>Differential-mode rejection (LCL)</b>	
80 dB adapter	
150 kHz to 1.5 MHz	(80 – 3) dB
1.5 MHz to 30 MHz	>(80 to 55) dB – 3 dB
60 dB adapter	
150 kHz to 1.5 MHz	(60 ± 3) dB
1.5 MHz to 30 MHz	(60 to 35) dB ± 3 dB
50 dB adapter	
150 kHz to 1.5 MHz	(50 ± 3) dB
1.5 MHz to 30 MHz	(50 to 25) dB ± 3 dB
<b>Decoupling attenuation</b>	
150 kHz to 1.5 MHz	>35 dB to 55 dB (linear increase with log frequency)
1.5 MHz to 80 MHz	>55 dB
<b>Maximum values</b>	
Max. permitted RF input voltage	17 V
Max. permitted DC and low-frequency AC voltage between symm. line and ground	160 V
Max. DC current (phantom current)	150 mA (current on each individual wire of one pair or on different pairs)
<b>Connectors</b>	
Output to receiver/input from signal generator	BNC connectors
EUT and auxiliary equipment (AE)	adapters with screw terminals and RJ45 connectors
<b>General data</b>	
Nominal temperature range	+ 5°C to 40°C
Storage temperature range	–40°C to + 70°C
Dimensions of basic unit	144 mm × 95 mm × 52 mm
Dimensions of unit with adapters	168 mm × 96 mm × 52 mm
Weight of unit with adapters	535 g
Weight of carrying case with basic adapter set	2170 g
Weight of option R&S®ENY 4-B1	330 g

<sup>1)</sup> The calibration data contain: asymmetrical impedance and phase, voltage-division factor, differential-mode rejection ratio.

## Ordering information

<b>Double Two-Wire ISN to CISPR22</b>	R&S®ENY22	1109.9508.02
<b>Four-Wire ISN to CISPR22</b>	R&S®ENY41	1110.0175.02
Option for R&S®ENY41: 3 additional RJ45 adapter sets	R&S®ENY4-B1	1109.9950.02
<b>Accessories supplied</b>	plastic carrying case with foam material, calibration data	
<b>Extra</b>		
ISN Functional Test Set	R&S®ENBY	1110.0298.03



Contents Overview

Chapter Overview

Type Index

R&amp;S Addresses



## Antenna Impedance Converter R&S® EZ-12



R&S® EZ-12 is a broadband matching unit for test receivers and spectrum analyzers with low-impedance inputs. It is used for high-impedance measurements of interference voltage at the feedpoint of a vehicle-mounted antenna in the long-, medium- and shortwave bands to VDE0879 Part 2 and CISPR25.

## Current Probe R&S® EZ-17

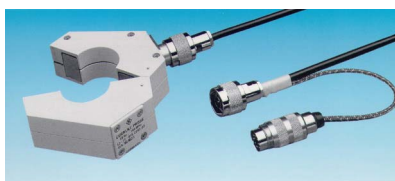

Model .02 with its extremely flat frequency response is optimal for current measurements as well as for measuring shielding effectiveness. Due to its high load capacity, model .03 is recommended for EMS measurements (bulk current injection). Thanks to their high magnetic overload capacity, these two models can be employed on power lines with currents up to 300 A without having an adverse effect on the measurement results.

For measurements in the VHF-FM range antenna signal can be switched to a separate 50- $\Omega$  input.

- ◆ Flat frequency response
- ◆ High sensitivity
- ◆ High overload capability
- ◆ Rugged metal case

The R&S® EZ-12 can be directly powered from Rohde&Schwarz test receivers or spectrum analyzers. Should this not be possible, it is recommended to use Power Supply R&S® HZ-9 (see page 94).

### Specifications in brief

Frequency range	150 kHz to 30 MHz (120 MHz)
RF input	DIN 415845
Input impedance	>100 k $\Omega$ , <10 pF (at 1 MHz)

### Current Probes R&S® EZ-17 comply with the following standards:

- ◆ CISPR 16-1 and VDE0876 Part 1 for measurement of RFI currents
- ◆ MIL-STD-461 CE 01 and CE 03
- ◆ VG95373 Part 20, VG95377 Part 14
- ◆ DEF-STAN59-41 DCE 01 and 02
- ◆ RTCA/DO-160 C

### Specifications in brief

	Model .02	Model .03
Frequency range	20 Hz to 100 MHz	20 Hz to 100 MHz
Range with constant transducer factor (–3 dB)	1 MHz to 100 MHz	2 MHz to 100 MHz
Transducer factor reduced by 20 dB/decade in range	20 Hz to 1 MHz	20 Hz to 2 MHz
RF connector	N female	N female
Source impedance	$\leq 0.8 \Omega$	$\leq 1 \Omega$
Transfer impedance $Z_T$ in range with constant transducer factor	3.16 $\Omega$	7.1 $\Omega$
Transducer factor k in range with flat frequency response	–10 dB	–17 dB
Load capacity (RF current measurement)		
Max. DC current or peak AC current	300 A (f <1 kHz)	300 A (f <1 kHz)
Max. RF current (rms)	2 A (f >1 MHz)	1 A (f >1 MHz)
Load capacity (EMS measurement)		
Max. power at RF connector	–	10 W (f >1 MHz)

### Ordering information

Current Probe R&S® EZ-17	0816.2063.02	0816.2063.03
--------------------------	--------------	--------------

Frequency range	150 kHz to 30 MHz (120 MHz)
Gain factor for	
direct input to antenna connector	0 $\pm$ 1 dB
correction factor –10 dB	+11.2 dB
AM output	BNC female, 50 $\Omega$
VSWR	$\leq 1.4$
FM output, remote controlled	BNC female, 50 $\Omega$
Noise voltage at output (input terminated with antenna simulator; average detector, BW = 10 kHz)	
f > 150 kHz	$\leq -5$ dB $\mu$ V
f > 500 kHz	$\leq -7$ dB $\mu$ V
1 dB compression point	>107 dB $\mu$ V
Power supply	+10 V $\pm$ 0.1 V
Current drain	<50 mA
Dimensions (W $\times$ H $\times$ D)	125 mm $\times$ 110 mm $\times$ 40 mm
Weight	0.6 kg

### Ordering information

Antenna Impedance Converter	R&S® EZ-12	1026.4800.03
-----------------------------	------------	--------------

### Main features

- ◆ High sensitivity and overload capability
- ◆ Wide frequency range
- ◆ High load capacity for DC and AC current (300 A)
- ◆ Small dimensions in spite of large inner diameter (30 mm)
- ◆ Simple clamping thanks to spring-loaded mechanism



Contents Overview

Chapter Overview

Type Index

R&amp;S Addresses







Contents Overview

Chapter Overview

Type Index

R&S Addresses



## 150 kHz Highpass R&S® EZ-25

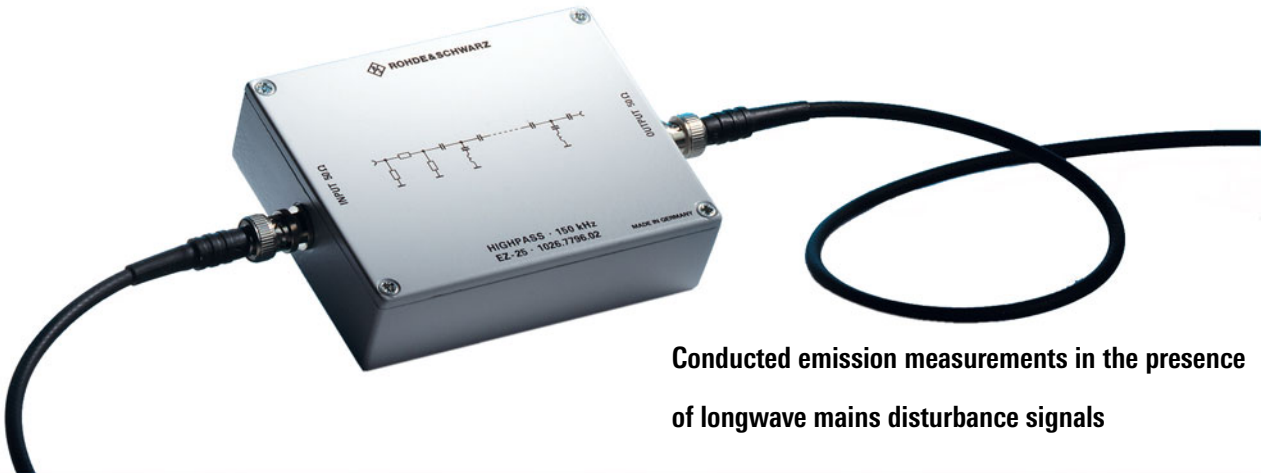

**Conducted emission measurements in the presence of longwave mains disturbance signals**

### Brief description

During signal transmission in low-voltage networks below 150 kHz, very high voltage levels may occur near the upper limit frequency of 148.5 kHz. This has been described in EN50065-1. The selectivity of the CISPR measuring receiver specified in CISPR 16-1 can cause problems in the conformance of the equipment with the RFI voltage limits at 150 kHz. For this reason a highpass has been specified in CISPR 16-1, which can be used in front of the CISPR measuring receiver in order to improve the selectivity and so to achieve the values defined in part 1 of EN50065,

without affecting the passband of the measuring receiver.

Problems with high interfering voltages in the range below 150 kHz can also occur with EUTs, which are not involved with low-voltage signalling. Only very few EMC standards specify limits in the frequency range below 150 kHz. Therefore equipment manufacturers use suppression filters with extremely steep slopes to meet the requirements above 150 kHz. In these cases measuring receivers may be overloaded, entailing measurement errors in the frequency range above 150 kHz. Highpass R&S® EZ-25 prevents this and allows exact measurements.

### Main features

- ◆ Conducted emission measurements to EN50065 Part 1
- ◆ Pass frequency range 150 kHz to 30 MHz
- ◆ Very steep slope acc. to CISPR 16-1: 1999 (selectivity)
- ◆ Suitable for any CISPR measuring receiver
- ◆ Relative attenuation >50 dB below 130 kHz
- ◆ Built-in 10 dB attenuation pad for exact 50 Ω termination of the LISN
- ◆ High pulse energy capability (50 mWs)
- ◆ Calibrated response

### Specifications

Passband	150 kHz to 30 MHz
Insertion loss in passband	9,5 dB to 11 dB (calibration data supplied)
Stopband	below 130 kHz
Minimum attenuation in stopband	60 dB
Attenuation in the transition region	
146 kHz	<12 dB
145 kHz	>12 dB
140 kHz	>24 dB
130 kHz	>60 dB

Maximum input voltage (continuous)	137 dBμV
Maximum impulse energy (50 μs)	50 mWs
Connectors	BNC female
Nominal temperature range	0°C to + 40°C
Dimensions (L × W × H)	144 mm × 95 mm × 34 mm
Weight	400 g

### Ordering information

<b>150 kHz Highpass</b>	R&S® EZ-25	1026.7796.02
<b>Accessories supplied</b>	Short description with calibration data	



Contents Overview

Chapter Overview

Type Index

R&S Addresses



## VHF Current Probe R&S® ESV-Z1

### Brief description

Current Probe R&S® ESV-Z1 is used for selective or broadband measurement of very small as well as of very large RF currents in electric lines. They are shielded against electrostatic effects and comply with CISPR16-1 and VDE0876.

### Specifications in brief

Frequency range	20 MHz to 300 MHz
Measurement range (average indication)	-33 dBμA to +117 dBμA (IF bandwidth 7.5 kHz)
Transfer admittance $Y_t = I_{in}/V_{out}$	0.1 S
Transducer factor $k = 20 \log(Y_t/s)$	-20 dB
Max. current (superimposed on RF current or peak AC current)	50 A
Max. diameter of conductor	13.5 mm
RF connector	N male, 50 Ω, 1 m
Coding connector (transducer factor)	12-contact Tuchel
Dimensions (dia./height)	55 mm/20 mm
Weight	130 g



### Ordering information

<b>VHF Current Probe</b>	R&S® ESV-Z1	0353.7019.02
--------------------------	-------------	--------------

## Pulse Limiter R&S® ESH3-Z2

### Brief description

#### Pulse Limiter R&S® ESH3-Z2, Attenuator R&S® ESH2Z11

High RF input levels and high-energy interfering pulses generated on artificial mains networks when the DUT is switched on and off can damage the RF input circuits of test receivers.

**Pulse Limiter R&S® ESH3-Z2** limits and **Attenuator R&S® ESH2Z11** reduces the interference level.

### Specifications in brief

	R&S® ESH3-Z2	R&S® ESH2Z11
Frequency range	0 Hz to 30 MHz	0 Hz to 1500 MHz
Insertion loss	10 dB ±0.3 dB	–
$f \leq 500$ MHz	–	20 dB ±0.25 dB
$f \leq 1000$ MHz	–	20 dB ±0.5 dB
$f \leq 1500$ MHz	–	20 dB ±1.5 dB
Frequency response	≤±0.3 dB	–
SWR with 50 Ω termination, input/output	≤1.06/≤1.25	–
Power-handling capacity in continuous mode	1 W	10 W
Pulse power-handling capacity	E = 0.1 Ws (6 μs)	P = 750 W (3 μs)
RF connectors	N (female/male), 50 Ω	N (female/male), 50 Ω
Dimensions (L × W × H or L × Ø)	94 mm × 25 mm × 25 mm	97 mm × 42 mm
Weight	120 g	150 g

### Ordering information

<b>Pulse Limiter</b>	R&S® ESH3-Z2	0357.8810.54
<b>Attenuator</b>	R&S® ESH2Z11	0349.7518.52



R&amp;S® ESH3-Z2

R&amp;S® ESH2Z11



## Probes R&S® ESH2-Z2, R&S® ESH2-Z3



R&S® ESH2-Z3

### Active Probe R&S® ESH2-Z2

The active probe is used for measuring AC voltages on lines that do not carry AC supply voltage.

### Passive Probe R&S® ESH2-Z3

The passive probe is suitable for measuring RFI voltages (on AC supply lines) to CISPR16-1 and VDE0876.

### Attenuator R&S® ESH2-Z31

For checking the interference source impedance to VDE 0877, Part 1 and CISPR16-2

## Specifications in brief

	R&S® ESH2-Z2	R&S® ESH2-Z3
Frequency range	9 kHz to 30 MHz	9 kHz to 30 MHz
Measurement range (average indication, IF bandwidth 200 Hz with Rohde&Schwarz Test Receivers)	-20 dB $\mu$ V to +120 dB $\mu$ V	+10 dB $\mu$ V to +150 dB $\mu$ V
Attenuation/error	10 dB/<1 dB	30 dB/-1 dB to +5 dB
Input impedance	118 k $\Omega$ $\pm$ 5%    8 pF	1.5 k $\Omega$ $\pm$ 2%    9 pF
Max. input voltage		
f <63 Hz	100 V	250 V
f <500 Hz	5 V	250 V
9 kHz to 30 MHz	3 V	30 V

## Ordering information

<b>Active or Passive Probe R&amp;S® ESH2-Zx</b>	0299.7210.52	0299.7810.52
Attenuator R&S® ESH2-Z31	0827.6513.02	0827.6513.02
BNC Adapter R&S® URV-Z	0241.1110.02	0241.1110.02

## RF Connecting Cables R&S® HFU2-Z4, R&S® HFU2-Z5

Low-loss cables for connecting antennas to test receivers. With this type of cable the outer sheath is filled with a special ferrite to reduce sheath currents.

## Ordering information

RF Connecting Cable		
12 m	R&S® HFU2-Z4	0252.0090.56

## Feeder Cables R&S® HZ-3, R&S® HZ-4

Connecting cables with 12-contact Tuchel male/female connectors for remote feeding of active antennas from the test receiver or from Power Supply R&S® HZ-9, page 94. The correction factor for automatic correction of unit and level display on the test receiver is also transmitted.

## Ordering information

Feeder Cable		
3 m	R&S® HZ-3	0837.3469.02
10 m	R&S® HZ-4	0816.0519.02





Contents Overview

Chapter Overview

Type Index

R&S Addresses



*From top to down: TV Test Receiver R&S® EFA, MPEG-2 Measurement Decoder and MPEG-2 Measurement Generator R&S® DVG*



Contents Overview

Chapter Overview

Type Index

R&S Addresses





Contents Overview

Chapter Overview

Type Index

R&amp;S Addresses



## Contents of Chapter 3

Designation	Type	Description	Page
DTV Recorder Generator	R&S® DVRG	Recording and generation of digital video streams	110
HDTV Sequences	R&S® DV-HDTV	Comprehensive collection of high-resolution transport and elementary streams	113
TestCard M Sequences	R&S® DV-TCM	Special transport stream collection for testing DTV receivers and decoders	115
MPEG-2 Measurement Generator	R&S® DVG	Digital test signals at a keystroke: large choice of signals (525- and 625-line standard), endless MPEG-2 sequence loop thanks to realtime updating of all time stamps	116
Stream Combiner™	R&S® DVG-B1	Generating user-specific MPEG-2 transport streams with the PC	118
Digital Video Quality Analyzer	R&S® DVQ	Indispensable tool in the quality assessment of digital DCT-coded video sequences	120
Quality Explorer™	R&S® DVQ-B1	Comprehensive quality and MPEG-2 elementary stream analysis	122
Multichannel Video Quality Analyzer	R&S® DVQM	Quality-of-service monitoring for up to 12 channels	123
MPEG-2 Measurement Decoder	R&S® DVMD	Analyzer and decoder in one unit: 19 realtime measurements at a time, analysis of data rates, integrated long-term report	127
MPEG-2 Realtime Monitor	R&S® DVRM	Realtime monitoring and analysis of MPEG-2 transport streams	129
Stream Explorer™	R&S® DVMD-B1	Enhanced MPEG-2 analysis with MPEG-2 Measurement Decoder DVMD	131
MPEG-2 Monitoring System	R&S® DVM	Transport stream monitoring in diverse DTV distribution networks	133
Digital Video Measurement System	R&S® DVM 400	Monitoring, analysis, recording and generation of MPEG-2 transport streams	135
MPEG-2/ATM Test Set	R&S® DVATM	Multifunctional MPEG-2 and ATM test set	138
DVD Compendium	R&S® TestDVD	Offers a unique compilation of many different video and audio streams for professional applications	140
TV Test Receiver Family	R&S® EFA	Test receivers and demodulators for analog and digital (DVB-C and DVB-T) TV signals	142
Measurement Software EFA-SCAN	R&S® EFA-K1	Fast recording and documentation of measurement values for the digital Test Receivers R&S® EFA	148
Portable SAT/TV/FM Test Receiver	R&S® EFL 100	Measurement features for analog TV, digital TV and FM radio in a single unit	150
CCVS+Component Generator	R&S® SAF	Multistandard generator for all TV applications; optionally PALplus and ITU-R 601: CCVS, YC <sub>B</sub> C <sub>R</sub> , RGB, S-VHS	152
CCVS Generator	R&S® SFF	Same as SAF, but CCVS only	
TV Test Transmitter	R&S® SFM	Vision and sound signals to all common TV standards	154
TV Test Transmitter	R&S® SFL	Digital signals for use in production	156
TV Test Transmitter	R&S® SFQ	Generation of DVB signals for satellite and cable and of analog broadband FM signals and noise signals	158
TV Generators	R&S® SGxF	Generation of video signals to PAL (SGPF), SECAM (SGSF) or NTSC (SGMF) standard	161
Video Analyzer	R&S® UAF	Fast analysis of 29 video parameters in studio quality	162
Digital Video Component Analyzer	R&S® VCA	Analyzer for digital studio signals	164
DTL Analysis	R&S® VCA-B11	Jitter analysis and spectral measurements	164
Video Measurement System	R&S® VSA	Video analyzer, vectorscope, oscilloscope, monitor and PC all in one unit; measurement of all video parameters	165
TV Test Receiver Option	R&S® VSA-B10	RF parameter measurement and monitoring in conjunction with Video Measurement System R&S® VSA	168



Contents Overview

Chapter Overview

Type Index

R&amp;S Addresses





Contents Overview

Chapter Overview

Type Index

R&amp;S Addresses



## DTV-Recorder Generator R&S® DVRG

### Recording and generation of digital video streams



### Brief description

R&S® DVRG is a universal processing platform for digital video streams. It allows the record and play of MPEG-2 transport streams. This is done either degradation free using the RAM when the transport stream is of limited length or directly using the hard disk. Minimum wear and tear can thus be achieved during continuous operation.

### Main features

- ◆ Replay of recorded transport streams
- ◆ Endless and seamless MPEG-2 generation
- ◆ Triggered recording for error analysis
- ◆ RAM or hard-disk based operation
- ◆ Hard disk space up to 144 GByte
- ◆ Large choice of test signals
- ◆ Compliant to ATSC and DVB
- ◆ TS data rate up to 214 Mbit/s
- ◆ Optional record and replay of uncompressed SDI video streams (to ITU-R BT. 601/656 or SMPTE 259M) at a data rate of 270 Mbit/s
- ◆ Embedded WindowsNT platform
- ◆ HDTV Sequences optional
- ◆ Test card M streams optional
- ◆ Software options
- ◆ Stream Combiner™ for creating user-specific transport streams
- ◆ Quality Explorer™ for analyzing video elementary streams
- ◆ Easy and self-explanatory operation

### Modes

#### Recording

A transport stream is first recorded in the RAM. If the volume of recorded data exceeds the available RAM capacity or if

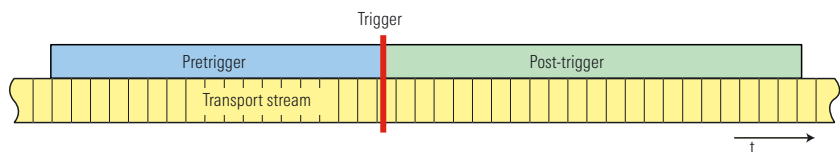

*The length of the pretrigger and posttrigger parts of a transport stream can be defined for a triggered recording with R&S® DVRG*

the transport stream is to be achieved, storage is in the form of a file on the hard disk in TRP format. For error analysis, recording can be controlled by means of an external trigger signal. The stored signal includes time sections of different lengths before and after the trigger event.

#### Replay of TRP files

Recorded transport streams can be replayed as often as required. The replay starts immediately after selecting the file with the data being buffered in the RAM. Any other data rate can be used for test purposes. In this mode, R&S® DVRG supports files in TRP/TS format.

#### Replay of GTS files

In this mode, transport stream files are replayed in an endless loop. The use of the GTS format provides discontinuity-

free signal generation in an endless and seamless loop. During replay a jitter of up to  $\pm 10$  ms with settable frequency and waveform can be superimposed on the PCR values (i.e. for stress tests of multiplexers and decoders).

### Test signals

R&S® DVRG produces a large number of predefined MPEG-2 transport streams to the ATSC and DVB standards at a key-stroke. The transport streams contain several elementary streams and consist of video, audio and other data (e.g. teletext or PRBS). Video streams with different data rates, formats, frame rates and contents are available.

The signal set comprises sequences with moving picture contents and some static test patterns. It includes known test patterns such as colour bar signals, zone plate, ITU-R 17/18/331, ITS1 to 4 and many others as well as the Rohde & Schwarz CODEC test pattern. Thanks to integrated test signals the analog outputs of a set-top box (or IRD) can be tested within seconds with the aid



Contents Overview

Chapter Overview

Type Index

R&amp;S Addresses



## DTV Recorder Generator R&S®DVRG

LC displays for  
File selection  
Recording  
Replaying

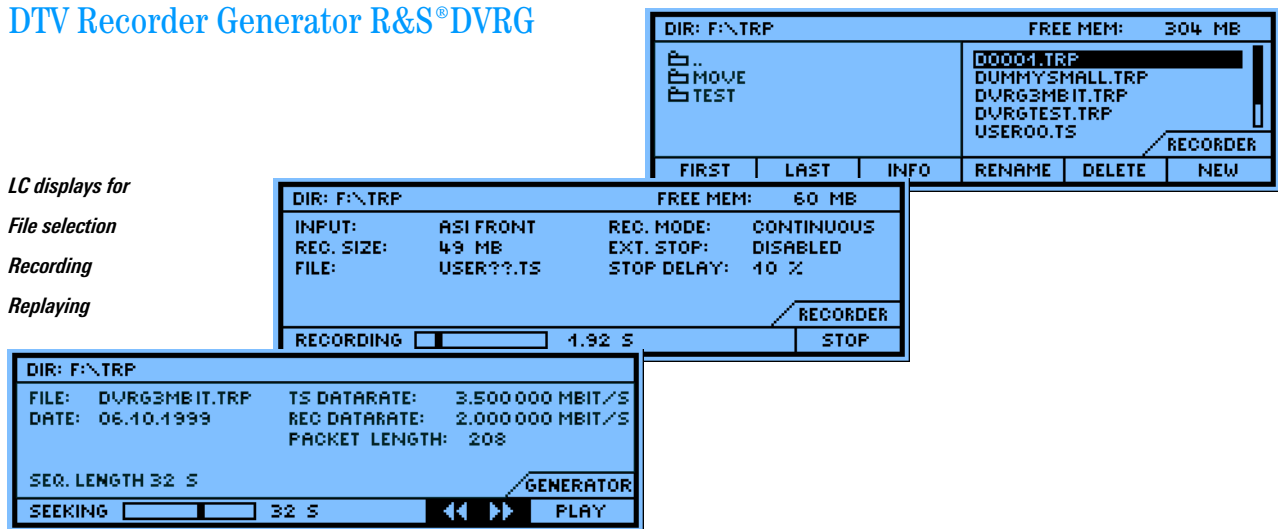

of a suitable video analyzer, e.g. R&S®VSA. In addition, integrated moving picture elements allow visual checking of the decoder functionality.

Audio data streams with different rates and frequencies contain the accompanying sound for the video sequences as well as special audio test signals.

Moreover, a large choice of further test signals is available: the option

R&S®DV-HDTV provides test sequences for high-definition TV. Both DVB and ATSC formats are supported. Due to its versatility, this collection allows testing of diverse devices to practically all world-wide standards. Further test signals are provided by the option R&S®DV-TCM. This option enables special tests through transport streams with dynamically varying structure. The transport streams also contain a large number of elementary streams in different formats. The formats

are partly changed even within a transport stream to enable easy testing of a large variety of decoder functions.

### Applications

Thanks to its versatility, flexibility and wide range of options, R&S®DVRG is the MPEG-2 platform for a whole variety of applications:

- ◆ Development of set-top boxes and all other instruments that process digital TV signals to the MPEG-2 standard
- ◆ Quality management by replaying standardized transport streams
- ◆ Production of digital TV components (e.g. set-top boxes, MPEG-2 decoders and multiplexers)
- ◆ Substitution signal source for playout center, cable headend and satellite uplink or downlink
- ◆ Error analysis by recording a part of the transport stream either before or after an external trigger event

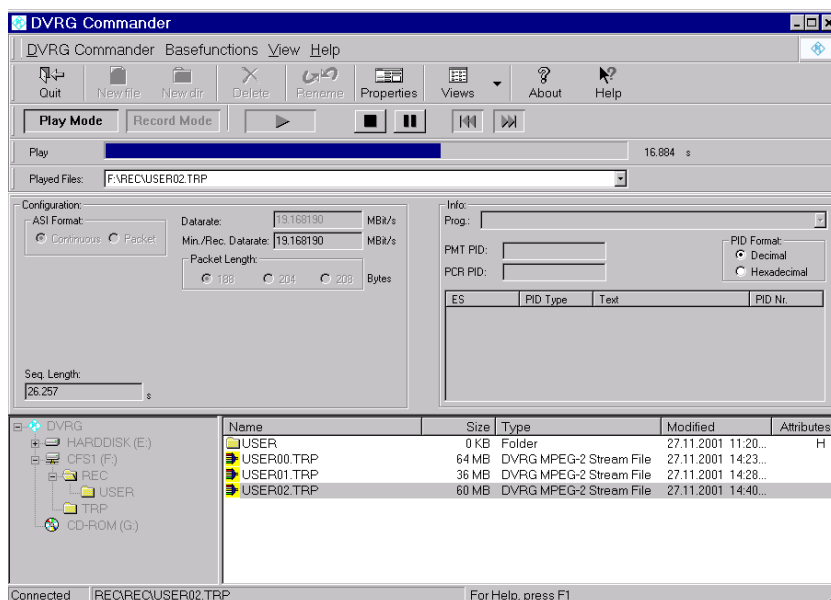

Windows user interface of R&S®DVRG for local and remote mode



Contents Overview

Chapter Overview

Type Index

R&amp;S Addresses



## DTV Recorder Generator R&amp;S®DVRG

## Specifications

You will find detailed and binding data on the enclosed CD (../DATASHEET/DVRG.pdf), or, for the latest updates, visit [www.rohde-schwarz.com](http://www.rohde-schwarz.com), search term: DVRG

## Ordering information

<b>DTV Recorder Generator</b>	R&S®DVRG	2083.1302.04
<b>Accessories supplied</b>	power cable, operating manual	
<b>Hardware options</b>		
Additional hard disk internal, 72 GB	R&S®DVRG-B2	2083.1919.02
SDI (ITU-R B.T. 601/656) Record&play	R&S®DVRG-B4	2083.1931.02
CD-R R/W drive (DVD read only)	R&S®DVRG-B5	2083.1948.02
SMPT-E-310 Interface	R&S®DVRG-B6	2083.1954.02
<b>Software options</b>		
Stream Combiner™ <sup>1)</sup>	R&S®DVG-B1	2068.9835.02
Quality Explorer™ <sup>2)</sup>	R&S®DVQ-B1	2079.7151.02
HDTV Sequences	R&S®DV-HDTV	2085.7650.02
TestCard M Sequences	R&S®DV-TCM	2085.7708.02
<b>Extras</b>		
Documentation of calibration test values	R&S®DRG-DCV	2082.0409.21
19" Adapter (2 HU) for installation with handles	R&S®ZZA-211	1096.3260.00
(rackmount without handles on request)		
Service manual		

1) See data sheet PD 0757.3611.

2) See data sheet PD 0757.5450.



Contents Overview

Chapter Overview

Type Index

R&amp;S Addresses







Contents Overview

Chapter Overview

Type Index

R&S Addresses



## HDTV Sequences R&S®DV-HDTV

**Comprehensive collection of  
high-resolution transport and  
elementary streams**

### Brief description

The R&S®DV-HDTV option is a versatile combination of MPEG-2-coded streams for high-definition TV. Its versatility enables the testing of diverse units to almost all worldwide standards. In addition to several video formats for the European and American television, MPEG-coded and AC-3-coded audio data are supplied.

All video streams, with audio streams combined to transport streams, can be loaded to the R&S®DVG and R&S®DVRG from Rohde&Schwarz, and directly replayed. To combine individual transport streams with the Stream Combiner™ software, all the elementary streams used are stored individually on the CD-ROMs. This allows easy creation of customized MPEG-2-compliant transport streams.

The transport streams supplied are stored in the GTS format, which was developed by Rohde&Schwarz, and which allows endless, continuous and errorfree replay also at the transition between the beginning and the end of a stored sequence. The Stream Combiner™ software can also create transport streams in the GTS format.

### Transport Streams PRK1080IGTS and PRK1080I\_L.GTS

	PRK1080I.GTS	PRK1080I_L.GTS
TS ID:	5002 (0 × 138A)	5003 (0 × 138B)
Length:	240 videoframes (9.600 s)	720 videoframes (38.400 s)
Runs on:	<input type="checkbox"/> DVG (20 MByte) <input checked="" type="checkbox"/> DVG (32 MByte) <input checked="" type="checkbox"/> DVRG	<input type="checkbox"/> DVG (20 MByte) <input type="checkbox"/> DVG (32 MByte) <input checked="" type="checkbox"/> DVRG
Tables:	<input checked="" type="checkbox"/> DVB <input type="checkbox"/> ATSC	
Transmission: (description)	<input type="checkbox"/> Satellite <input checked="" type="checkbox"/> Cable <input type="checkbox"/> Terrestrial	

Program:

Program 1: Service\_name: PARK MPEG

Program 2: Service\_name: PARK AC-3

#### Video:



*Park scene from the transport and elementary stream combination*

MPEG-2 MP@HL		Single stream shared by both programs (PID 0x0100)		
Frames/s	Lines/picture	Pixels/line	Mbit/s	
<input checked="" type="checkbox"/> 25	<input type="checkbox"/> 480	<input type="checkbox"/> 704	<input checked="" type="checkbox"/> 16	<input checked="" type="checkbox"/> Seamless at sequence end
<input type="checkbox"/> 29.97	<input type="checkbox"/> 720	<input type="checkbox"/> 1280		<input checked="" type="checkbox"/> Scene cuts
<input type="checkbox"/> 50	<input checked="" type="checkbox"/> 1080	<input checked="" type="checkbox"/> 1920		<input checked="" type="checkbox"/> Moving Picture
<input type="checkbox"/> 59.94				
<input type="checkbox"/> 24				
				<input checked="" type="checkbox"/> One PES per videoframe

#### Audio:

Background noise

Program 1: MPEG-1 Layer 2 Stereo

Program 2: AC-3 (3/2 LFE)

ksample/s	kbit/s	PRK1080I.GTS	PRK1080I_L.GTS
<input type="checkbox"/> 32	<input type="checkbox"/> 192	<input type="checkbox"/> Seamless at sequence end	<input checked="" type="checkbox"/> Seamless at sequence end
<input type="checkbox"/> 44.1	<input type="checkbox"/> 256	<input type="checkbox"/> Continuous tone	<input type="checkbox"/> Continuous tone
<input checked="" type="checkbox"/> 48	<input checked="" type="checkbox"/> 384		



Contents Overview

Chapter Overview

Type Index

R&S Addresses





Contents Overview

Chapter Overview

Type Index

R&S Addresses



## HDTV Sequences R&S®DV-HDTV

### Main features

- ◆ Large choice of transport streams compatible with DVB and ATSC
- ◆ All video streams also available as elementary streams for individual combination with Stream Combiner™ software
- ◆ Ready for use with R&S®DVRG or R&S®DVG
- ◆ Support of all customary video formats and frame rates
- ◆ Different audio formats: MPEG-1 Layer 2 and AC-3
- ◆ Endless replay with non-interrupting transition from sequence end to sequence start for video and audio in the event of replay by R&S®DVRG

### Characteristics

#### Video and audio formats

The collection of transport and elementary streams comprises a variety of sequences. They are based on several test patterns and real film sequences. All video sequences are available as elementary streams in various resolutions and frame rates. They are complemented by audio signals in different formats, both in MPEG-1 Layer 2 and AC-3. The transport streams are designed to comply with the DVB and ATSC standards according to the formats of the video streams included. Furthermore, the transmission path (terrestrial, cable or satellite), defined by the transport stream, varies.



*Frame examples taken from the transport and elementary stream collection*

### Specifications

#### Video formats supported

Frequency in Hz	Sampling	Number of lines	Number of columns
24	progressive	1080	1920
25	interlaced	1080	1920
50	progressive	720	1280
29	interlaced	1080	1920
59	progressive	720	1280
59	progressive	480	704

#### Audio formats supported

MPEG-1 Layer 2 and AC-3	
<b>Video contents</b>	Fireworks Public park Shark and other fish in the aquarium HDTV test pattern Colour bars Horizontal ramp Horizontal frequency sweep
<b>Sequence length</b>	up to 32.032 seconds

### Ordering information

HDTV Sequences		
for R&S®DVG and R&S®DVRG	R&S®DV-HDTV	2085.7650.02
Transport Stream Upgrade on CD-ROM with special parallel cable for installation on R&S®DVG		
Stream Combiner™	R&S®DVG-Z1	2069.0419.00
MPEG-2 Measurement Generator	R&S®DVG-B1	2068.9835.02
DTV Recorder Generator	R&S®DVG	2068.8600.03
	R&S®DVRG	2083.1302.02



Contents Overview

Chapter Overview

Type Index

R&S Addresses





Contents Overview

Chapter Overview

Type Index

R&S Addresses



## Test Card M Sequences R&S®DV-TCM

**Special transport stream collection for testing DTV receivers and decoders**

*Example from transport stream collection*



### Brief description

This option from Rohde&Schwarz enhances the wide choice of already available transport streams by a large number of special streams particularly designed for testing and development of DTV decoders and receivers. The transport streams provided by this option have been derived from the Test Card M libraries of Snell & Wilcox. They have been adapted by Rohde&Schwarz for endless<sup>1)</sup>, continuous and error-free replay by the R&S®DVRG and R&S®DVG, and allow simple and effective testing of standard as well as special DTV receiver and decoder functions without the need of any additional measuring equipment.

- ◆ Large variety of DVB- and ATSC-specific transport streams
- ◆ Immediately ready for replay by MPEG-2 players R&S®DVRG and R&S®DVG
- ◆ Endless replay
- ◆ Comprehensive PSI, SI and PSIP data
- ◆ SDTV and HDTV test sequences
- ◆ MPEG-1 Layer II and AC-3 audio formats
- ◆ Testing of DVB- and ATSC-specific functions
- ◆ Testing of audio/video synchronism

### Supported video and audio formats

All elementary video streams are encoded in 4:2:0 format.

DVB			
Frequency <sup>1)</sup>	Sampling	No. of columns	No. of lines
25	interlaced	720	576
Audio: MPEG-1 Layer II			
ATSC			
29.97	interlaced	1920	1080
59.94	progressive	1280	720
29.97	interlaced	720	480
59.94	progressive	720	480
Audio: AC-3			

<sup>1)</sup> The repetition frequency refers to frames. In interlaced display mode, the field repetition frequency is twice the specified frame rate.

### Main features

<sup>1)</sup> Realtime calculation of all time-relevant parameters ensures error-free replay even at the transition from the start to the end of the stored sequence. This refers to the transport stream syntax as well as to the elementary streams.

### Ordering information

Test Card M Sequences <sup>1)</sup>	R&S®DV-TCM	2085.7708.02
Transport Stream Update on CD with special parallel cable for installation on R&S®DVG	R&S®DVG-Z1	2069.0419.00
MPEG-2 Measurement Generator	R&S®DVG	2068.8600.03
DTV Recorder Generator	R&S®DVRG	2083.1302.02

<sup>1)</sup> If you order the option for MPEG players already supplied, please specify Serial No. and Type of the instrument on which the option is to be installed.



Contents Overview

Chapter Overview

Type Index

R&S Addresses





Contents Overview

Chapter Overview

Type Index

R&amp;S Addresses



## MPEG-2 Measurement Generator R&S®DVG

**Large choice of digital TV test signals (525- and 625-line standard), endless MPEG-2 sequence loop thanks to realtime updating of all time stamps**



### Brief description

MPEG-2 Measurement Generator R&S®DVG is a universal generator for digital TV signals in the form of transport streams in line with the MPEG-2 standard. The structure of these streams and the data reduction methods employed were developed and standardized by the Moving Picture Experts Group (MPEG) and the Digital Video Broadcasting (DVB) project. The transport stream contains several programs, each consisting of several substreams carrying video, audio and data signals.

R&S®DVG generates in an endless loop a large variety of selectable MPEG-2 transport streams with combined video, audio and data sequences as contents and is thus a favourably priced and compact alternative to expensive MPEG-2 encoders with multiplexer and external standard generators.

Complementary to R&S®DVG, MPEG-2 Measurement Decoder R&S®DVMD is offered for realtime monitoring, analyzing and decoding of MPEG-2 transport streams.

### Main features

- ◆ Endless MPEG-2 sequence loop: all the required time information is continuously updated during playback of the transport stream, and the signal is available without any interruption
- ◆ The output data rate can be varied as desired and thus adapted to the specifications of the transmission link or devices under test
- ◆ Thanks to the settable PID of the program elements, R&S®DVG is ideal for use as a substitution signal source
- ◆ A built-in PCR (program clock reference) jitter generator is available for stress testing of decoder PLLs

The optional Stream Combiner™ software can be used to configure any new transport streams from the supplied or customer-specific elementary streams (ES) in addition to stored transport streams.

A PC card interface on the front panel allows the exchange of user-defined transport streams via a small exchangeable hard disk.

### Applications

The digital data streams generated by R&S®DVG are used as test signals for a variety of equipment employed on digital TV transmission links – from the studio to the domestic receiver. One field of application of R&S®DVG therefore is in the development, production, quality management and servicing of equipment processing MPEG-2-coded signals.

Further applications are in the field of signal distribution and transmission (e.g. cable headends), where the generator can be used as a substitution signal source.

### Test signals

R&S®DVG offers a variety of predefined MPEG-2 transport streams which can be called at a keystroke. Video data streams of different contents and data rates are available. The set of signals stored comprises moving picture sequences as well as stationary test patterns. For fast testing of set-top boxes, i.e. integrated receiver decoders (IRT), R&S®DVG provides the Rohde&Schwarz codec test pattern.



Contents Overview

Chapter Overview

Type Index

R&amp;S Addresses





Contents Overview

Chapter Overview

Type Index

R&amp;S Addresses



## MPEG-2 Measurement Generator R&S®DVG

Thanks to integrated test signals in the upper and lower picture area and using a suitable video analyzer such as R&S®VSA, analog interfaces can be tested out within a few seconds. In addition, moving elements at the corners and in the center of the picture allow visual checking of the decoder functions. Audio data streams, which are also available at different data rates, comprise the sound component accompanying the video sequences as well as special audio test signals.

Moreover, a large choice of further test signals is available: the option R&S®DV-HDTV provides test sequences for high-definition TV. Both DVB and ATSC formats are supported. Due to its versatility, this collection allows testing of diverse devices to practically all worldwide standards. Further test signals are provided by the option R&S®DV-TCM. This option enables special tests through transport streams with dynamically varying structure. The transport streams also contain a large number of elementary streams in different formats. The formats are partly changed even within a transport stream to enable easy testing of a large variety of decoder functions.

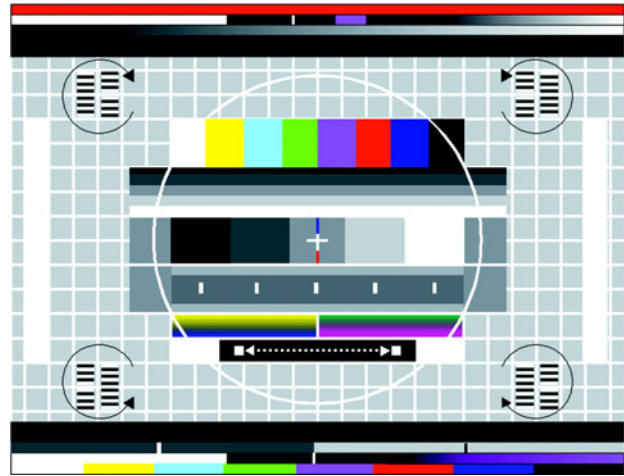

*Rohde & Schwarz codec test pattern*

### Specifications

You will find detailed and binding data on the enclosed CD (*../DATASHEET/DVG.pdf*), or, for the latest updates, visit [www.rohde-schwarz.com](http://www.rohde-schwarz.com), search term: DVG

### Ordering information

<b>MPEG-2 Measurement Generator</b>	R&S®DVG	2068.8600.03
<b>Accessories supplied</b>	power cable, operating manual, null modem cable	
<b>Options</b>		
Stream Combiner™ Software	R&S®DVG-B1	2068.9835.02
Calibration Data Documentation	R&S®DVG-DCV	2082.0490.14
Transport Stream Update on CD-ROM with special parallel cable	R&S®DVG-Z1	2069.0419.00
HDTV Sequences	R&S®DV-HDTV	2085.7650.02
TestCard M Sequences	R&S®DV-TCM	2085.7708.02
<b>Extras</b>		
19" Adapter (1 HU)	R&S®ZZA-91	0396.4870.00
Service Manual		2069.0354.24



Contents Overview

Chapter Overview

Type Index

R&amp;S Addresses





Contents Overview

Chapter Overview

Type Index

R&amp;S Addresses



## Stream Combiner™ R&S® DVG-B1

### Generating user-specific MPEG-2 transport streams with the PC

#### Brief description

Stream Combiner™ Software R&S® DVG-B1 in conjunction with MPEG-2 Generator R&S® DVG allows user-specific transport streams to be generated. The software runs under Windows 9x/NT/2000 on any PC or laptop. The data are loaded into the R&S® DVG via a parallel interface or a PC card hard disk. The user-friendly operating concept with integrated help function ensures fast and efficient working right from the start without any special knowledge of MPEG-2 or DVB being required.

#### Main features

- ◆ Generation of user-specific transport streams
- ◆ Elementary stream library
- ◆ Insertion of external elementary stream files
- ◆ Editing PSI and SI tables as required
- ◆ Setting of defined nonconformal states
- ◆ Windows 9x/NT/2000/XP operating system

#### Defining a user-specific transport stream

A new transport stream can be defined very easily step by step with the Stream

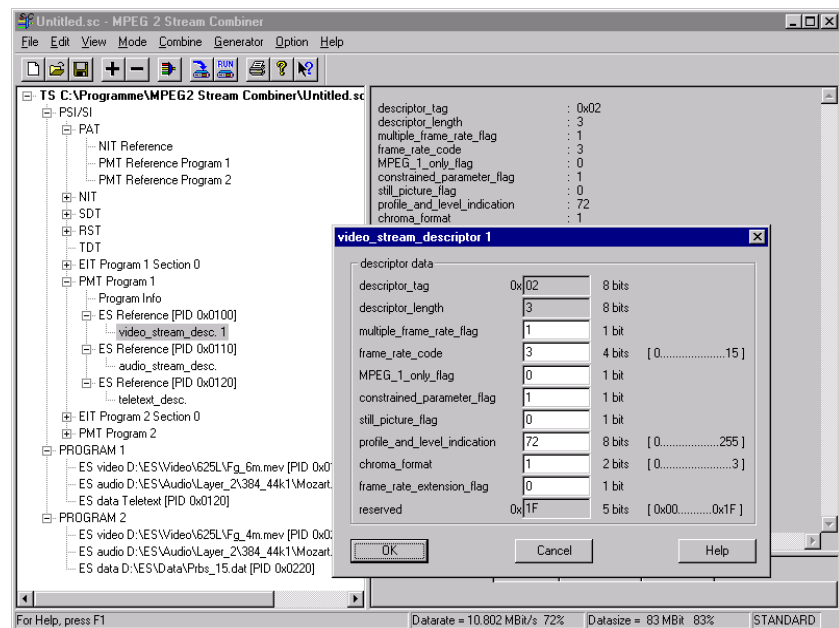

Fig. 1: Display of transport stream structure with information on individual elements

Combiner™. In the lefthand part of the program window (Fig. 1), all elements of the transport stream that have already been defined are represented as a tree structure. In the righthand part of the window, detailed information on the individual elements is displayed. The elements can be selected by means of a mouseclick.

#### Adding programs

In the first step, the user adds the desired number of programs (max. 6) to the transport stream. Stream Combiner™ automatically generates the required PSI tables, e.g. PAT and PMT, and represents these tables in the tree structure. The tables contain predefined default settings which can be changed as required.

#### Adding elementary streams

In the second step the desired elementary streams such as video, audio or data are added to the programs. Each program may contain up to 6 elementary streams. The software comes with a comprehensive elementary stream library from which the user can configure his specific

transport stream. Stream Combiner™ automatically updates the relevant PSI tables every time a new elementary stream is added.

#### Adding service information

In the third step, further SI and PSI tables (PAT, PMT, CAT, NIT, BAT, SDT, EIT, RST, TDT, TOT, ST, SIT, DIT) can be added to the transport stream. Each of these tables can be fully edited; the repetition rates can be set independently for each table.

#### Generating the transport stream data file for the R&S® DVG

As a final step, Stream Combiner™ generates a transport stream data file for the MPEG-2 Generator R&S® DVG. The file can be transferred to the R&S® DVG directly via cable. Alternatively, a PC card hard disk can be used. This is expedient if the generated transport stream is to be installed in several generators. R&S® DVG generates the new transport stream in the same way as the preconfigured stored signals as an endless MPEG-2 sequence with all time stamps being continuously updated.



Contents Overview

Chapter Overview

Type Index

R&amp;S Addresses



## Stream Combiner™ R&S® DVG-B1

### Inserting external elementary streams (data files)

Besides the elementary streams from the library supplied, Stream Combiner™ allows external elementary streams (binary files to ISO/IEC 13818, MP@ML) to be inserted. Such files are offered by various suppliers on the Internet or on CD-ROMs (MPG, VID, M2V, MP2, AUD, M2A file extensions). Stream Combiner™ first checks whether the external file is suitable for integration, and then processes the file so that it can be inserted into the new transport stream. Thus it is ensured that the R&S® DVG plays back the new transport stream as an endless MPEG-2 loop.

With option R&S® DV-HDTV Rohde&Schwarz also offers special signals for high-resolution TV. All included video sequences are also available for simple integration with the Stream Combiner™ as an elementary stream.

### Editing a user-specific transport stream

All transport streams generated with the Stream Combiner™ can subsequently be modified. This is possible for the elementary streams and for all tables of a trans-

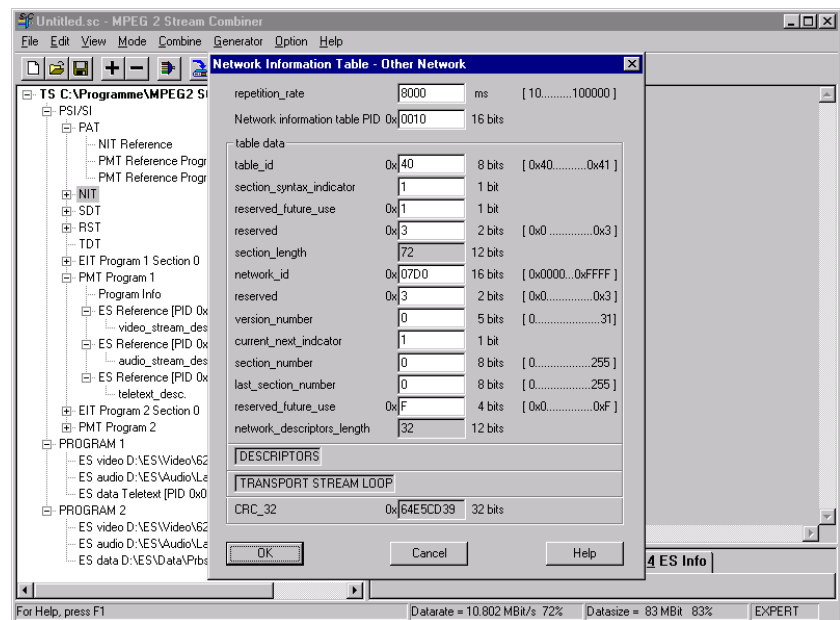

Fig. 2: Editing individual tables using the Network Information Table (NIT) as an example

port stream. Editing can be performed after the respective file has been opened. The Stream Combiner™ operates in the same mode as for generating a new transport stream, i.e. the tree structure and the contents of the tables are displayed. Any desired element can be modified, deleted from or added to the transport stream.

### Generating defined nonconformal states

Stream Combiner™ offers various possibilities of integrating nonconformal states into a transport stream:

- ◆ Insertion of descriptors into tables for which they are not intended
- ◆ Insertion of wrong information into tables and descriptors
- ◆ Changing the repetition rate of tables
- ◆ Removing specific tables
- ◆ Introducing an offset between elementary stream clock (PTS, DTS) and PCR
- ◆ Switching off PCR, PTS and DTS updating at the end of a video/audio sequence

### Specifications

You will find detailed and binding data on the enclosed CD (../DATASHEET/DVG-B1.pdf), or, for the latest updates, visit [www.rohde-schwarz.com](http://www.rohde-schwarz.com), search term: DVG-B1

### Ordering information

Stream Combiner™	R&S® DVG-B1	2068.9835.02
------------------	-------------	--------------



Contents Overview

Chapter Overview

Type Index

R&S Addresses



## Digital Video Quality Analyzer R&S® DVQ

### Getting the picture on picture quality



### Brief description

With Digital Video Quality Analyzer R&S® DVQ the assessment of picture quality according to subjective criteria becomes an objective realtime measurement method. This method is based on the analysis of video data and can thus also be used where no reference video material is available.

To this end, the optional PC software Quality Explorer™ is available, allowing complete display and analysis of all coding data as well as convenient remote control of R&S® DVQ and display of the recorded quality data.

The increasing use of digital, data-compressed TV signals calls for monitoring and assessment of the picture quality. Picture quality assessment is very strongly influenced by the subjective perception of the human eye. R&S® DVQ is a tool that ideally satisfies both requirements. It determines the picture quality in

relation to digital compression and evaluates the results according to the subjective criteria of visual perception.

### Applications

- ◆ Quality monitoring in distribution networks
- ◆ Program quality assessment
- ◆ Development, evaluation and setting of operational hardware
- ◆ Testing of set-top boxes

### Main features

- ◆ Realtime measurement
- ◆ No reference signal required
- ◆ SSCQE scaling of quality levels
- ◆ Monitoring of picture freeze, picture and audio loss
- ◆ Recording of quality profile (long-term)
- ◆ ITU-R601 and MPEG-2 inputs
- ◆ Histogram representation of quality levels
- ◆ Internal event and error report and statistics
- ◆ Program decoding

### Characteristics

In addition to the analysis unit, R&S® DVQ also has a built-in decoder for audio and video data in the format Mainprofile@MainLevel and 4:2:2 Profile@MainLevel. The program being analyzed is decoded and can simultaneously be viewed on a connected video monitor (CCVS or ITU-R 601 formats). The audio signals are available at the connectors both in analog and digital form (AES/EBU).

A MPEG-2 transport stream usually contains several programs made up of video and audio data streams. For automatic monitoring of all programs, a scan mode is provided in R&S® DVQ allowing all or selected programs to be successively analyzed for picture quality and interference over a selectable period of time.

R&S® DVQ has a built-in 32-Mbit memory for transport stream data. Depending on the data rate of the video stream, the memory is sufficient for storing a video data sequence of approx. 5 s to 10 s. The sequence can be read out for in-depth analysis via one of the remote-control interfaces using for instance the Quality Explorer™.

For comparative quality measurements the quality analysis can simultaneously be carried out on two different signals. Quality analysis is carried out completely

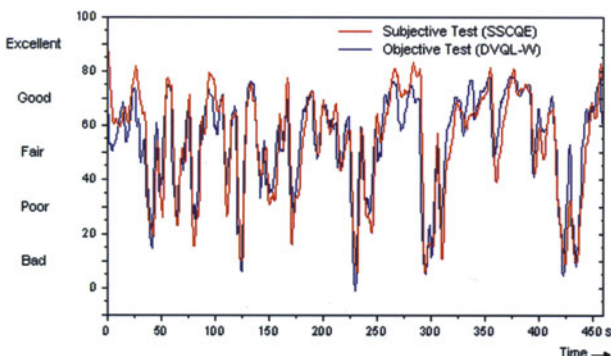

*Comparison of objective test results (R&S® DVQL-W) and subjective quality assessments (SSCQE) for 480 s sample sequence*



Contents Overview

Chapter Overview

Type Index

R&S Addresses







Contents Overview

Chapter Overview

Type Index

R&S Addresses



## Digital Video Quality Analyzer R&S® DVQ

independently for each signal and the final result is formed from the differences found. There is no pixel comparison of two video data sources in this mode either.

Altogether 12 relay outputs which can be allocated to one or several (ORed) events are fitted as standard. The switching mode (active when open or closed) can

be set separately for each relay. In addition to the data interfaces floating switching contacts are thus available for external signalling of failures and quality degradations.

### Operation

R&S® DVQ can be controlled manually via the keypad with fast-access keys for the

main menus and softkeys for the sub-menus.

The displayed contents of the clearly arranged LCD is inserted into the decoded picture at the video output. With a recorder connected the quality ratings can be logged together with the associated picture contents.

### Specifications

**You will find detailed and binding data on the enclosed CD (../DATASHEET/DVQ.pdf), or, for the latest updates, visit [www.rohde-schwarz.com](http://www.rohde-schwarz.com), search term: DVQ**

### Ordering information

<b>Digital Video Quality Analyzer</b>	R&S® DVQ	2079.6003.02
<b>Accessories supplied</b>	power cable, operating manual, audio adapter (Lemo-Triax to XLR), modem bypass cable	
<b>Options</b>		
Quality Explorer™ Software	R&S® DVQ-B1	2079.7151.02
Calibration Data Documentation	R&S® DVQ-DCV	2082.0490.20
<b>Extras</b>		
19" Rack Adapter (2 HU)	R&S® ZZA-211	1096.3260.00
Service Manual		



Contents Overview

Chapter Overview

Type Index

R&S Addresses





Contents Overview

Chapter Overview

Type Index

R&S Addresses



## Quality Explorer™ R&S®DVQ-B1

**Comprehensive quality  
and MPEG-2 elementary stream  
analysis**

*Clear display of header information with  
Elementary Stream Analyzer, illustrated by  
picture header*

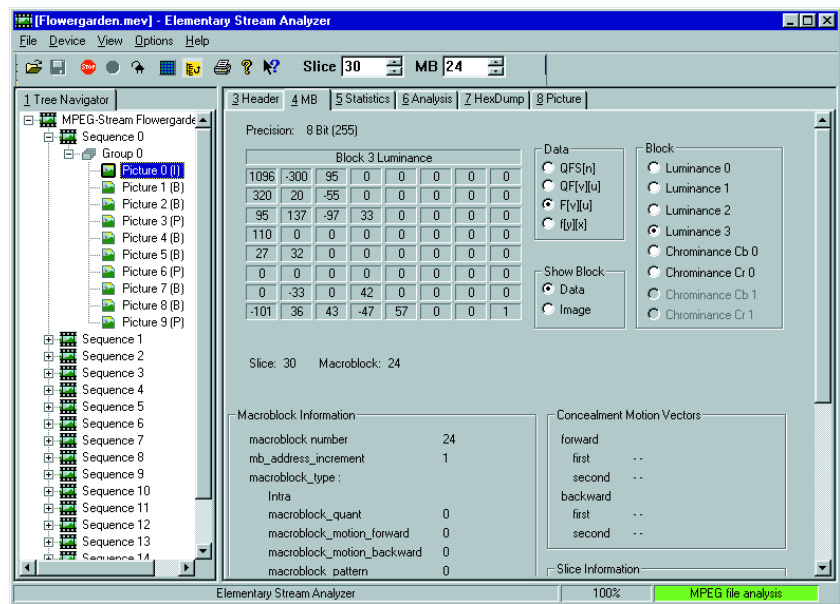

### Brief description

Quality Explorer™ R&S®DVQ-B1 is a software package that performs comprehensive analysis on MPEG-2-coded transport streams. It can be used either on an external PC connected to R&S®DVQ or fully independently of R&S®DVQ for elementary stream analysis from data media (e.g. hard disk, CD-ROM).

R&S®DVQ-B1 comprises two independent tools: The Quality Monitor reads the quality parameters provided by the Digital Video Quality Analyzer R&S®DVQ in real time via the remote-control interface. It displays the quality levels graphi-

cally as a histogram. Archiving on data storage media is also possible.

The Elementary Stream Analyzer analyzes the content of MPEG-2-coded video elementary streams. For this purpose R&S®DVQ has a 32-Mbit internal buffer memory for the elementary stream to be analyzed. The elementary stream buffered in R&S®DVQ can also be stored as a PC file.

Alternatively, elementary streams available in the form of PC files can be analyzed. Therefore, Quality Explorer™ can be used on other instrument platforms without the R&S®DVQ.

Full remote control of R&S®DVQ is provided by a library routine (DLL) supplied with the software and the Quality Monitor's user interface.

The software runs under Windows9x or WindowsNT/2000/XP on any PC or laptop connected to the R&S®DVQ via an RS-232-C interface or network (10BaseT) interface. The easy-to-operate software, as well as the clear presentation of the analysis results in windows of variable size, ensure speed and success right from the start.

### Specifications

Elementary Stream Analyzer	
MPEG-2 formats	
Profile	MP (main profile 4:2:0) 422P (4:2:2 profile)
Aspect ratios	any, e.g. 4:3, 14:9, 16:9
Picture formats	any SDTV&HDTV

### System requirements

PC or laptop with Pentium processor (Pentium II with 266 MHz clock frequency recommended, min. Pentium I with 100 MHz), Windows9x or WindowsNT/2000/XP operating system, min. 32 Mbyte RAM, required memory on hard disk approx. 20 Mbyte, 1 free serial RS-232-C interface (recommended data rate 115 kbit/s) or 1 free 10BaseT-network interface, CD-ROM drive, 1 parallel printer interface

### Ordering information

<b>Quality Explorer™</b>	R&S®DVQ-B1	2079.7151.02
<b>Equipment supplied</b>	CD-ROM with setup program, serial cable for connecting R&S®DVQ to the PC, dongle for the parallel printer output of the PC, manual	



Contents Overview

Chapter Overview

Type Index

R&S Addresses





Contents Overview

Chapter Overview

Type Index

R&amp;S Addresses



## Multichannel Digital Video Quality Analyzer R&S®DVQM

### Always in the picture about picture quality in all channels

#### Brief description

The R&S®DVQM is the multichannel version of the successful Digital Video Quality Analyzer R&S®DVQ. The R&S®DVQM can combine the performance of up to twelve R&S®DVQs. The resulting large variety of configurations allows the R&S®DVQM to be optimally adapted to different requirement profiles.

For configuration of the individual analyzer boards and for readout of the measurement results, the R&S®DVQM comes with the R&S®DTV NetView PC software running under Windows. This software enables remote communication with all instruments via the Ethernet interface where the instruments are not used at the same place or there are major distances between the measuring instruments and the PC. The software can be individually adapted to different instrument configurations and provides a fast overview of the analysis results of all the instruments.

Video quality analysis is optionally available (R&S®DVQM-B4) for the individual analyzer boards of the R&S®DVQM.

#### Main features

- ◆ Simultaneous monitoring of up to 12 channels
- ◆ Optional monitoring of video quality with SSCQE scaling of quality levels
- ◆ No reference signal required

- ◆ 12 programmable alarm relay contacts per channel
- ◆ Selectable alarm thresholds
- ◆ SDI interface
- ◆ Video outputs: SDI and CCVS
- ◆ Compatible with DVB and ATSC
- ◆ Ethernet interface (TCP/IP-SNMP)
- ◆ Windows software for remote control
- ◆ Internal event and error report and statistics
- ◆ Optional decoding of CA programs

#### Possible configurations

The basic unit of the R&S®DVQM comes with two analyzer boards. The instrument can accommodate another 10 boards. These may be analyzer boards for simultaneous monitoring of 12 channels, or descrambling boards for decoding of pay TV programs. Up to six scrambled programs can be monitored simultaneously (6 descrambling boards and 6 analyzer boards).

The analyzer boards can be inserted into any of the 12 slots, whereas the descrambling boards are subject to the following condition: they must be inserted into the slot immediately following the associated analyzer board. This means that slot 1 may not contain a descrambling board.

Analyzer boards with and without associated descrambling boards may be combined as desired. Altogether, up to 12 unscrambled or 6 scrambled programs can be analyzed simultaneously.



#### Analyzer board characteristics

##### Test parameters

Each analyzer board can be used to monitor all the relevant parameters of the video and audio elementary streams of the selected program. Moreover, they determine whether a valid transport stream is present or whether there are failures. The hysteresis for the detection of transport streams or failures can be set by the user.

The video stream is checked for picture freeze and picture loss. The check is made using the threshold values for spatial and temporal activities as well as the period for which the threshold values have not been adhered to. All threshold values for the determination of picture freeze and picture loss can be set by the user.

The audio stream, if available (audio sync), is checked for its volume separately for the right and left channels. If the volume is below a certain threshold for a defined period, this indicates a sound loss. Minimum volume and maxi-



Contents Overview

Chapter Overview

Type Index

R&amp;S Addresses





Contents Overview

Chapter Overview

Type Index

R&S Addresses



## Multichannel Digital Video Quality Analyzer R&S®DVQM

imum period can be set by the user. AC-3-coded audio streams are also monitored in this way. For this purpose, the audio signal is downconverted to a stereo signal according to a method especially specified by Dolby so that this signal can be monitored in the described way. The R&S®DVQM-B4 option allows additional continuous monitoring of the picture quality.

### Applications

The unique combination of realtime capability and independence from a reference signal opens up a wide field of applications for the R&S®DVQM. Long-term recording and evaluation of the quality parameters allows a quality assessment that is closer to reality than that of short standardized test sequences.

#### Quality monitoring in distribution networks

The R&S®DVQM allows the picture quality to be monitored during program transmission and in realtime. Degradations in quality and failures can be recognized at an early stage so that remedial measures can be taken in time. Since the analysis method employed does not require any reference signals, the R&S®DVQM is suitable for use wherever MPEG-2-coded video data is transmitted or received. The R&S®DVQM can be used to document the picture quality versus time at the gateway between two different networks. This can, for example, be used as an evidence for the contractual performance of services.

The network compatibility of the R&S®DVQM ensures optimum integration into monitoring systems.

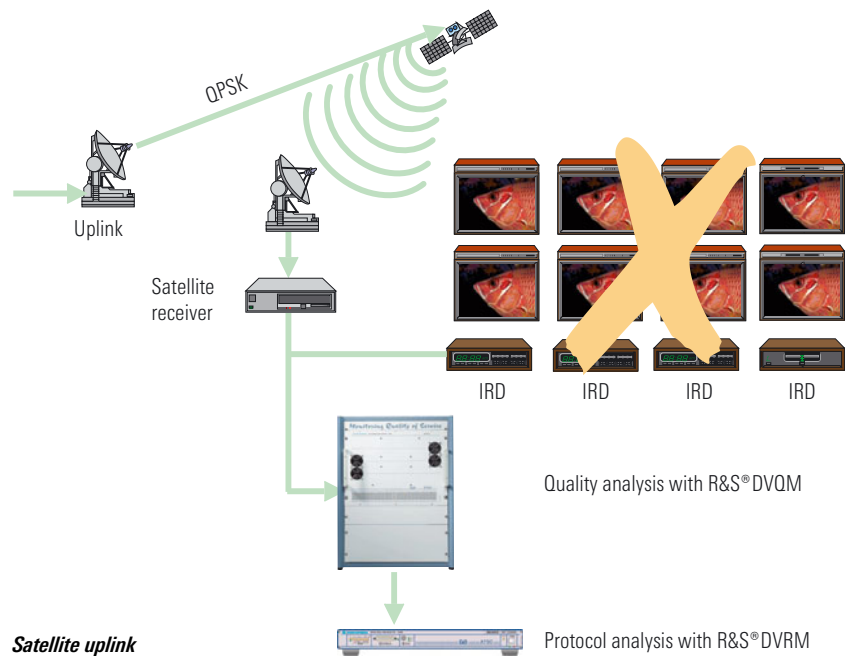
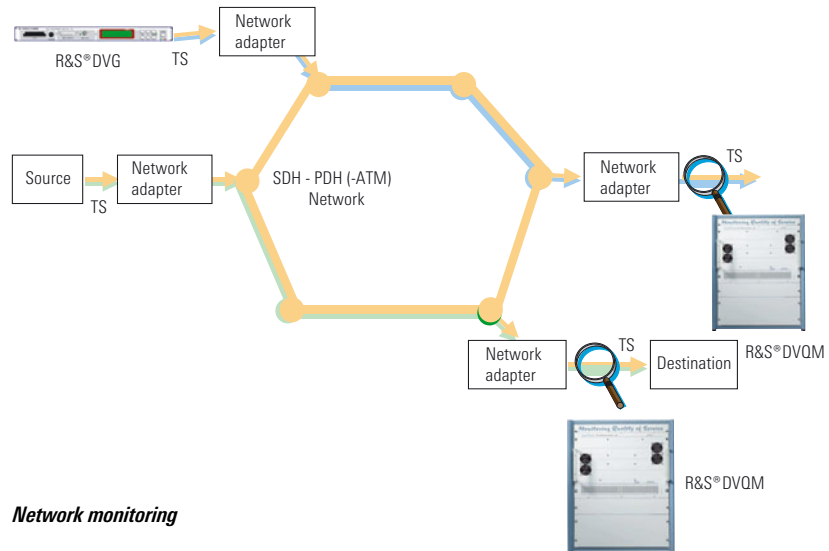

The R&S®DVQM in conjunction with the DTV Recorder Generator R&S®DVRG (see data sheet PD 0757.5708) and, optionally, the Realtime Monitor R&S®DVRM (see data sheet PD 0757.5566) forms a complete monitoring system with recording capability even for very rare disturbances.

The relay outputs of the R&S®DVQM and the R&S®DVRM are connected to the trigger input of the R&S®DVRG, whose elaborate trigger characteristics make it possible to save a transport stream section of arbitrary length before and after an error event for subsequent detailed analysis.



Contents Overview

Chapter Overview

Type Index

R&S Addresses



## Multichannel Digital Video Quality Analyzer R&S®DVQM

### Program quality assessment

Again, it is a benefit that the measurement method is based on the analysis of video data and does not need reference pictures. Instead of lengthy observations carried out by a test person, unknown program material can automatically be checked for its picture quality (e.g. satellite uplink).

### Options

#### Analyzer Board (R&S®DVQM-B2)

An additional Analyzer Board R&S®DVQM-B2 can be ordered for monitoring a further channel. It corresponds to the two analyzer boards contained in the basic R&S®DVQM model. The video quality analysis for this board is activated – same as for the boards contained in the basic unit – via the R&S®DVQM-B4 option.

#### Video Quality Analysis R&S®DVQM-B4

Video quality analysis of the individual R&S®DVQM analyzer boards is optionally available. The measurement functions of the analyzer board are enhanced by this option to include determination of the picture quality. The option allows continuous analysis of the video quality of a video elementary stream according to a patented weighting algorithm, which takes into account the masking effects of the eye and thus furnishes measurement results that are adapted to the human perception. If the result is below a defined quality level, an alarm message and a report entry are generated.

#### Descrambling Options R&S®DVQMB1x

As a rule, pay TV programs are transmitted in scrambled form to protect them against unauthorized access. Different CA systems are used, and the programs

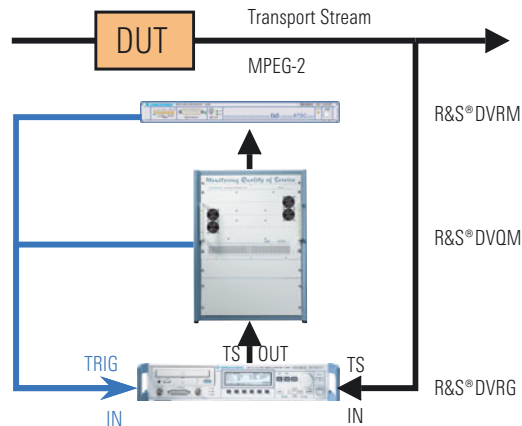

Stream Explorer™ Transport Stream Analysis  
Quality Explorer™ Video Elementary Stream Analysis

#### Error analyses using R&S®DVRG and realtime analyzers

have to be descrambled accordingly in order to analyze, decode and display the picture and sound contents.

The R&S®DVQM comes with options for the most common CA systems. The options include a card reader, the slot for which is provided on the rear of the R&S®DVQM. It takes up the smart card that is issued by the program broadcaster and serves as the subscriber's identity card. The smart card is not included in the R&S®DVQMB1x options.

### Software

The R&S®DVQM functions are considerably enhanced by several software packages. The R&S®DTV NetView software comes with the R&S®DVQM for easy detection and clear display of the errors detected by the R&S®DVQM, as well as for easy configuration of all devices connected.

The Quality Monitor, which also comes with the R&S®DVQM, allows continuous display and recording of the measurement results of an analyzer board and can conveniently be started from R&S®DTV NetView for individual analyzer boards. The Elementary Stream Analyzer allows in-depth analysis of an MPEG-2 video elementary stream monitored by an analyzer board (option R&S®DVQ-B1).

#### R&S®DTV NetView

One of the assets of R&S®DTV NetView is its high flexibility allowing it to be adapted to quite different monitoring system configurations. The adaptation is made with the aid of a special file reflecting the configuration of the monitoring system. Several R&S®DVQMs and R&S®DVQs can be integrated. R&S®DTV NetView also allows the integration of the R&S®DVRM and the R&S®DVMD; these are Rohde&Schwarz instruments for monitoring and analyzing of the transport stream syntax.



Contents Overview

Chapter Overview

Type Index

R&S Addresses



## Multichannel Digital Video Quality Analyzer R&S® DVQM

After opening the configuration file via R&S® DTV NetView, all devices mentioned above are initialized and the structure read is displayed as a tree structure in the program window to provide a good overview of all the devices contained in the system. This tree structure also serves for selecting individual devices in order to start further programs (Quality Monitor™ or Stream Explorer™), to configure these devices, or to display the status information for selected devices only.

### Quality Monitor

This software, which is also ideal for use with a R&S® DVQ, allows remote control of each analyzer board (R&S® DVQM-B2) in the same way as the R&S® DTV NetView software. In addition, it allows easy and continuous reading of the measured values: spatial and temporal activities, data rate and R&S® DVQL-W quality levels. The Quality Monitor can be installed on an external PC with Windows 9x or NT/2000/XP operating system. The connection to the R&S® DVQM is established via an RS-232-C or Ethernet interface. Using a compatible interchange format (CSV), the measured values can be continuously

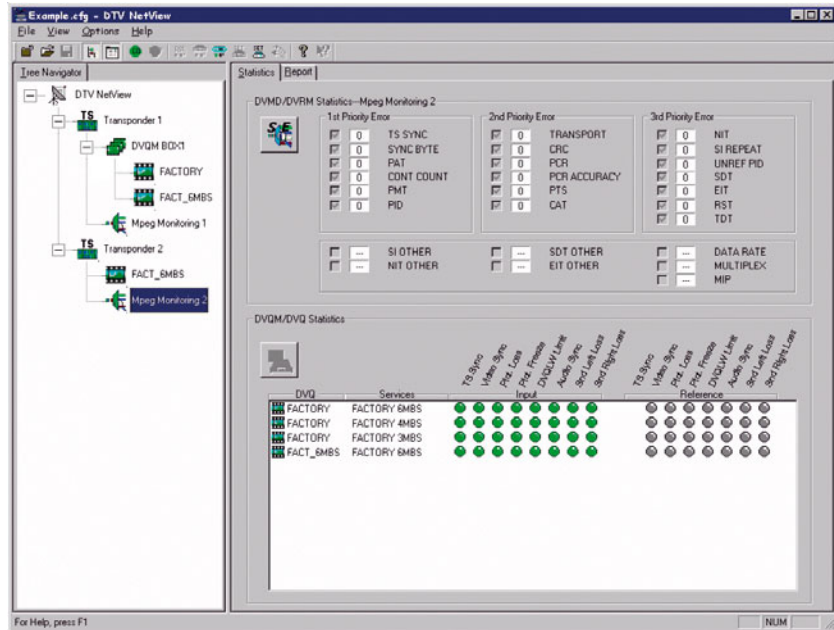

R&S® DTV NetView

stored in a data memory and graphically displayed. An automatic, user-definable save function allows convenient storage of measurement results over any period of time.

### Specifications

You will find detailed and binding data on the enclosed CD (./DATASHEET/DVQM.pdf), or, for the latest updates, visit [www.rohde-schwarz.com](http://www.rohde-schwarz.com), search term: DVQM

### Ordering information

Multichannel Digital Video Quality Analyzer		
Basic unit with two analyzer boards (R&S® DVQM-B2) plus R&S® DTV NetView remote-control software	R&S® DVQM	2088.0004.02
<b>Options</b>		
Additional Analyzer Board (max. 10 optional R&S® DVQM-B2 per R&S® DVQM)	R&S® DVQM-B2	2088.0027.02
Video Quality Analysis for R&S® DVQM-B2 (activates digital video quality determination for an Analyzer Board R&S® DVQM-B2)	R&S® DVQM-B4	2088.0062.02
Quality Explorer™ (only one license required for several analyzer boards)	R&S® DVQ-B1	2079.7151.02

CA systems		
One slot required per system (max. 6 per R&S® DVQM)		
Conax, Nagravision or Viaccess	R&S® DVQMB10	2088.0491.02
Irdeto	R&S® DVQMB11	2088.0504.02
Mediaguard	R&S® DVQMB12	2088.0510.02
NDS-Videoguard B SkyB	R&S® DVQMB15	2088.0540.02
BetaCrypt		
BetaDigital	R&S® DVQMB16	2088.0556.02
DTAG	R&S® DVQMB16	2088.0556.03
ORF	R&S® DVQMB16	2088.0556.04
Cryptoworks	R&S® DVQMB17	2088.0562.02



Contents Overview

Chapter Overview

Type Index

R&S Addresses





Contents Overview

Chapter Overview

Type Index

R&amp;S Addresses



## MPEG-2 Measurement Decoder R&S®DVMD

**25 DVB or 18 ATSC realtime measurements at a time, analyzer and decoder in one unit, analysis of data rates, integrated long-term report, on-screen display on video monitor**



*MPEG-2 Measurement Decoder R&S®DVMD*

### Brief description

MPEG-2 Measurement Decoder R&S®DVMD monitors and analyzes the MPEG-2 transport stream. It indicates the contents and provides comprehensive information on the quality of the transport stream.

The combination of decoder and analyzer in one unit with conventional operating concept (no PC system) makes R&S®DVMD the waveform monitor of digital television. It is suitable for use wherever MPEG-2 signals have to be checked.

Realtime measurements and simultaneous in-depth analysis yield extremely fast results. This makes R&S®DVMD an indispensable tool in development, in troubleshooting as well as in quality management and production.

Another important application is in the final inspection of MPEG-2 signals before they leave the studio. While R&S®DVMD checks the video and audio signals at the output, error information is inserted directly into the decoded program (on-screen display).

Remote control capability allows integration into automatic monitoring networks. R&S®DVMD is thus ideal for network operators.

Complementary to Decoder R&S®DVMD, MPEG-2 Measurement Generator R&S®DVG (page 92) is offered for providing continuous MPEG-2 transport streams made up of video, audio and data sequences in an endless loop.

### Analyzer

The analyzer functions of R&S®DVMD comprise a protocol analysis of the measured MPEG-2 transport stream in real-time. All measurements are in conformance with the Measurement Guidelines for DVB Systems (ETR 290) of the European DVB project or based on these guidelines (ATSC-Standard). In the DVB mode, the repetition rates of all EIT/SDT/NIT "other" tables are monitored in real-time in addition to ETR 290.

Any error occurring is directly indicated by front-panel LEDs. R&S®DVMD also detects sporadic errors. Moreover it provides error statistics showing how often a particular type of error has occurred within a specified time interval. A list (REPORT; see lower figure on righthand page) giving detailed information on the errors occurred including date and time

can be obtained. The list contains up to 1000 entries and may be edited to cover exclusively a single type of error.

In addition, the R&S®DVMD analyzes the MIP packets (megaframe initialization packets) that are inserted into the transport stream in order to synchronize the transmitters of DVB-T single-frequency networks. If there is an error, the trigger/capture facilities of R&S®DVMD can be used to freeze part of the transport stream affected by the error (approx. 2 Mbit) and output it, analyzed down to bit level, via the RS-232-C interface.

In addition to in-depth analysis, the optional Stream Explorer™ software (see page 107) allows further online measurements with graphic display on the screen (e.g. data rates, PCR jitter, etc).

### Decoder

An MPEG-2 transport stream usually consists of a number of programs which may contain video, audio and data streams (elementary streams). R&S®DVMD decodes a video and an audio stream from the selected program. The decoded video signal is simultaneously output in CCVS, analog Y/C and digital serial ITU-R601 formats. Audio signals are output as analog stereo signals and as digital AES/EBU signals.



Contents Overview

Chapter Overview

Type Index

R&amp;S Addresses





Contents Overview

Chapter Overview

Type Index

R&S Addresses



## MPEG-2 Measurement Decoder R&S®DVMD

### Optional alarm lines and parallel printer interface

In addition to a second parallel printer interface, 12 alarm lines for signalling errors detected in the transport stream are available. Each alarm line can be allocated to one or several (ORed) types of errors. The contacts close to ground and in case of an error they can be chosen to close or open.

### Specifications

You will find detailed and binding data on the enclosed CD (./DATASHEET/DVMD.pdf), or, for the latest updates, visit [www.rohde-schwarz.com](http://www.rohde-schwarz.com), search term: DVMD

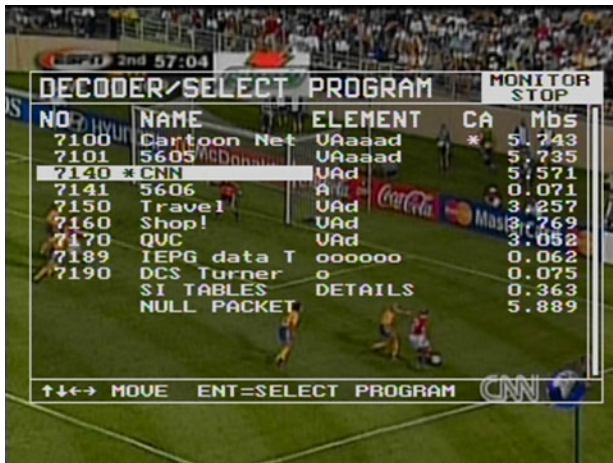

List of all elementary streams of a program

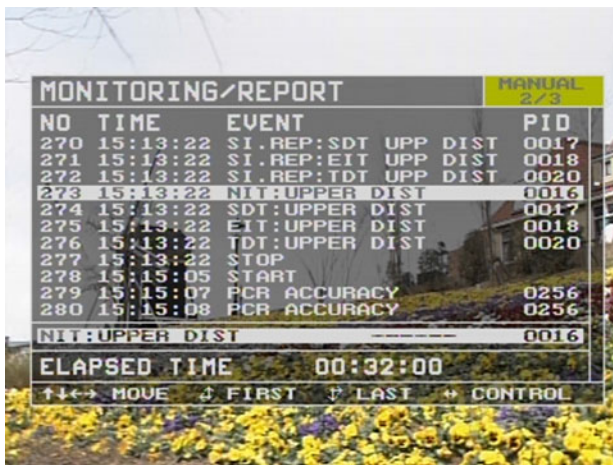

Error report with detailed information on causes of errors

### Ordering information

<b>MPEG-2 Measurement Decoder (DVB)</b>	R&S®DVMD	2068.8597.02
<b>Accessories supplied</b>	power cable, operating manual, audio adapter (LEMO Triax to XLR)	
<b>Options</b>		
Stream Explorer™ Software	R&S®DVMD-B1	2068.8597.02
Distribution as ATSC standard	R&S®DVMD-B2	2068.9341.00
Alarm Lines + Parallel Printer Interface	R&S®DVMD-B5	2068.9393.02
Calibration Data Documentation	R&S®DVMD-DCV	2082.0490.15
<b>Extras</b>		
19" Adapter (1 HU)	R&S®ZZA-91	0396.4870.00
Service Manual		2069.0348.24



Contents Overview

Chapter Overview

Type Index

R&S Addresses







Contents Overview

Chapter Overview

Type Index

R&S Addresses



## MPEG-2 Realtime Monitor R&S® DVRM

### Realtime monitoring and analysis of MPEG-2 transport streams



MPEG-2 Realtime Monitor R&S® DVRM

### Brief description

R&S® DVRM is the optimized solution for the continuous monitoring of MPEG-2 transport streams in real time. The measurements performed are necessary to ensure smooth interplay of all components of a DTV transmission network.

Local control and display elements are not provided because the R&S® DVRM is intended for use in networked monitoring systems with one or more the R&S® DVRMs being integrated.

### Main features

- ◆ 26 DVB or 19 ATSC realtime measurements at a time
- ◆ Integrated long-term report
- ◆ Analysis of data rates
- ◆ Trigger-on-error function
- ◆ Remote control via supplied PC software
- ◆ 12 built-in relays for error signalling

*If the supplied PC software running under Windows 9x or NT/2000/XP is used, three information blocks are available simultaneously:*

1. Structure of transport stream with all elements shown in the form of a tree or list (left)
2. Current status as well as error seconds of each error measured in realtime (top right)
3. Chronological list of all errors detected (bottom right)

### Analyzer

The analyzer functions of R&S® DVRM comprise a protocol analysis of the measured MPEG-2 transport stream in real-time. All measurements are in conformance with the Measurement Guidelines for DVB Systems (ETR 290) of the European DVB project or based on these guidelines (ATSC-Standard). In the DVB mode, the repetition rates of all EIT/SDT/NIT "other" tables are monitored in real-time in addition to ETR 290.

Any error occurring is directly indicated by front-panel LEDs. R&S® DVRM also

detects sporadic errors. Moreover it provides error statistics showing how often a particular type of error has occurred within a specified time interval. A list (REPORT) giving detailed information on the errors occurred including date and time can be obtained. The list contains up to 1000 entries and may be edited to cover exclusively a single type of error.

In addition, the R&S® DVRM analyzes the MIP packets (megaframe initialization packets) that are inserted into the transport stream in order to synchronize the transmitters of DVB-T single-frequency networks.

The screenshot shows the 'MPEG2 Realtime Monitor - Monitoring' software interface. It features a tree view on the left showing the structure of the transport stream, including PSI/SI, PAT, PMT tables, and various programs. The main area is divided into three sections: '1st Priority Error', '2nd Priority Error', and '3rd Priority Error', each with a list of error codes and descriptions. Below these is a 'Modify Report Filter' section with checkboxes for various error types. At the bottom, there is a table showing a chronological list of errors with columns for No., Time, Code, Event, Detail, Pid, and Program.

No.	Time	Code	Event	Detail	Pid	Program
004	18:15:46	240	PTS	0.960 s	0x0200	Program 1 [Bounce]
005	18:15:46	325	SI.REP-TDT UPP DIST	232.1...	0x0014	
006	18:15:46	381	TDT.UPPER DIST	232.1...	0x0014	
007	18:15:47	325	SI.REP-TDT UPP DIST	233.2...	0x0014	
008	18:15:47	381	TDT.UPPER DIST	233.2...	0x0014	
009	18:15:48	200	TRANSPORT		0x0201	
010	18:15:48	325	SI.REP-TDT UPP DIST	234.2...	0x0014	
011	18:15:48	381	TDT.UPPER DIST	234.2...	0x0014	
012	18:15:49	325	SI.REP-TDT UPP DIST	235.2...	0x0014	
013	18:15:49	381	TDT.UPPER DIST	235.2...	0x0014	
014	18:15:50	214	CRCEIT		0x0012	PSI/SI, EIT
015	18:15:50	325	SI.REP-TDT UPP DIST	236.2...	0x0014	
016	18:15:50	381	TDT.UPPER DIST	236.2...	0x0014	
017	18:15:51	325	SI.REP-TDT UPP DIST	237.2...	0x0014	
018	18:15:51	381	TDT.UPPER DIST	237.2...	0x0014	
019	18:15:52	110	SYNC BYTE: SINGLE			
020	18:15:52	325	SI.REP-TDT UPP DIST	238.2...	0x0014	
021	18:15:52	381	TDT.UPPER DIST	238.2...	0x0014	



Contents Overview

Chapter Overview

Type Index

R&S Addresses





Contents Overview

Chapter Overview

Type Index

R&S Addresses



## MPEG-2 Realtime Monitor R&S®DVRM

If there is an error, the trigger/capture facilities of R&S®DVRM can be used to freeze part of the transport stream affected by the error (approx. 2 Mbit) and output it, analyzed down to bit and byte level, via the RS-232-C interface.

In addition to in-depth analysis, the optional Stream Explorer™ software (see page 107) allows further online measurements with graphic display on the screen (e.g. data rates, PCR jitter, etc).

### Remote control

In addition to readout and display of complete error information, the MPEG-2 Realtime Monitor software allows full remote control of R&S®DVRM. Moreover, it offers moving graphical representation of the data rates of all transport stream elements in the form of bargraphs. Apart from continuous storage of the error report on hard disk, the software enables integration of R&S®DVRM into networked monitoring systems via the COM/DCOM interface.

### ATSC-Standard R&S®DVRM-B2

When ordered with option R&S®DVRM-B2, the unit comes preconfigured for ATSC. For changeover of R&S®DVRM to the respective other standard, a PC Windows software is supplied with R&S®DVRM.

### Specifications

**You will find detailed and binding data on the enclosed CD (./DATASHEET/DVRM.pdf), or, for the latest updates, visit [www.rohde-schwarz.com](http://www.rohde-schwarz.com), search term: DVRM**

### Ordering information

<b>MPEG-2 Realtime Monitor</b>	R&S®DVRM	2068.8580.02
Equipment supplied	power cable, modem bypass cable, operating manual, CD-ROM with PC operating software, update firmware for ATSC and DVB standards, factory-configured for DVB standard	
<b>Options</b>		
Configuration for ATSC standard	R&S®DVRM-B2	2068.9606.00
Stream Explorer™ software	R&S®DVMD-B1	2068.9406.02
Documentation of calibration values	R&S®DRM-DCV	2082.0490.24
<b>Extras</b>		
19" adapter (1 HU)	R&S®ZZA-91	0396.4870.00
Service manual		2069.0348.24



Contents Overview

Chapter Overview

Type Index

R&S Addresses



## Stream Explorer™ R&S®DVMD-B1

**Enhanced MPEG-2 analysis with  
MPEG-2 Measurement Decoder  
R&S® DVMD or Realtime Monitor  
R&S® DVRM**

*Fig. 1: All transport stream details under control with List Navigator and Packet Interpreter (DVB mode)*

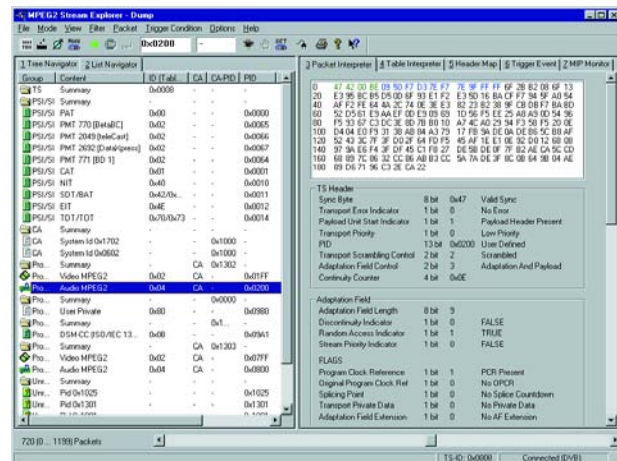

### Brief description

Stream Explorer™ Software R&S® DVMD-B1 enhances the MPEG-2 Measurement Decoder R&S® DVMD (page 103) to form a universal analysis system for MPEG-2 transport streams. The software runs under Windows9x/NT/2000 on any PC or laptop connected to the R&S® DVMD via a serial interface. The easy-to-operate software and the clear presentation of test results ensure efficient working right from the start. R&S® DVMD can buffer a transport stream of up to 2 Mbit and transfer it on request via the serial interface to the Stream Explorer™. R&S® DVMD uses several data or event filters (TRIGGER), which can be activated via the Stream Explorer™. The investigated data quantity of the transport stream can thus be considerably increased if required. Moreover, the software can activate realtime analyses in the R&S® DVMD and output the results as moving graphic representations. The realtime measurement functions of R&S® DVMD are thus considerably enhanced.

### Five operating modes

- ◆ **DUMP:** for comprehensive analysis of transport stream contents
- ◆ **TRIGGER:** for detailed investigation of errors in transport streams
- ◆ **MEASURE:** for graphic display of transport stream parameters in real-time

- ◆ **MONITORING:** for remote control
- ◆ **OFFLINE:** for storage and subsequent recall of any test scenarios (available for all four operating modes named above)

### DUMP

This operating mode allows detailed analysis of the contents of transport streams (TS). The transport stream contents is represented by Stream Explorer™ in hexadecimal format as well as in an interpreted form. This makes it very easy for the user to recognize any irregularities that may occur.

#### The analyzed transport stream data can be filtered as follows:

- ◆ only TS packets with a specific PID
- ◆ only TS packets with adaptation field
- ◆ only TS packets with start of a PES packet (payload unit start indicator set)

Combinations of the above selection criteria are also possible. Irrespective of the filter settings, Stream Explorer™ additionally determines the complete contents structure of the transport stream.

#### Display modes

- ◆ **NAVIGATOR:** Display of transport stream contents as a tree structure

(Fig. 2, left) or in tabular form (Fig. 1, left) with general information about elementary streams such as PID, stream ID, data rate and information about scrambling. This display mode is always available together with a second display mode

- ◆ **PACKET INTERPRETER:** (Fig. 1, right) Display of a TS packet in hexadecimal format and at the same time as an interpreted list of all elements contained in the transport stream. A colour code for the various parts of the packet (header, adaptation field, payload, etc) makes for a clear representation. The packets are selected either via the NAVIGATOR or via a software slide switch allowing all buffered packets to be addressed in their original sequence

- ◆ **TABLE INTERPRETER:** (Fig. 2, right) Lists all elements of a selected table and interprets the contents. The following tables can be selected:
  - All standards: CAT, PAT, PMT, PT
  - DVB: BAT, DIT, EIT, NIT, RST, SDT, SIT, ST, TDT, TOT
  - ATSC: CVCT, EIT, ETT, MGT, PIT, RRT, STT, TVCT

- ◆ **HEADER MAP:** Gives an overview of the distribution of elementary stream packets within the transport stream. The headers of a selected elementary stream are highlighted

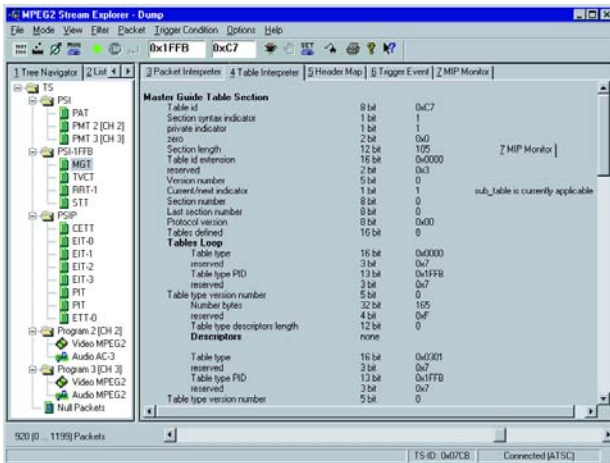

**Fig. 2:** Clear representation of transport stream structure with Tree Navigator and of Table Interpreter (ATSC mode)

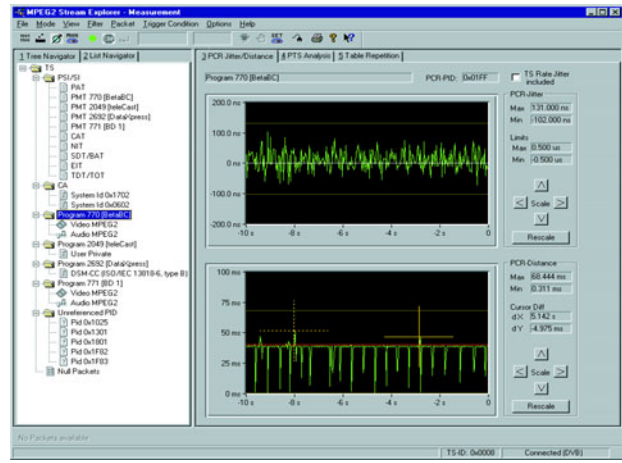

**Fig. 3:** Realtime measurement of PCR jitter and PCR spacings (DVB mode)

## TRIGGER

If an error occurs in the transport stream applied to R&S® DVMD, the data in the region of the error are stored in the R&S® DVMD and made available to Stream Explorer™ for evaluation. The cause of the error can thus reliably be detected and displayed in detail.

**TRIGGER EVENT:** This display mode is additionally available for error investigation. It shows the structure elements in which the error occurred. Faulty data are shown in red. The type of error is explained in addition.

**MIP MONITOR:** Regularly updated display of MIP (megaframe initialization packets) data. These data are indispensable in SFNs (single frequency networks) to enable synchronized operation of the various transmitters.

## MEASURE

This operating mode allows realtime analysis of several transport stream parameters and graphic display in the form of bargraphs or traces:

- ◆ PCR jitter (Fig. 3): accuracy and overall jitter MGF1, MGF2 and MGF3
- ◆ Spacing of PCR values in transport stream (Fig. 3)
- ◆ Spacing of elementary-stream-related PTS values
- ◆ PTS/PCR difference
- ◆ Spacing of PSI, SI and PSIP tables
- ◆ Data rates of elementary streams

## MONITORING

Full remote control of the R&S® DVMD is integrated in this operating mode, including display, filtering and storage of the monitoring report.

## System requirements

PC or laptop with Pentium processor (recommended clock frequency min. 100 MHz), Windows 9x or NT/2000/XP operating system, min. 16 Mbyte RAM (Windows NT/2000/XP: 32 Mbyte), required space on hard disk approx. 10 Mbyte, 1 free RS-232-C interface (recommended data rate: 115 kbit/s), 1 parallel printer interface, 3.5" disk drive

## Ordering information

<b>Stream Explorer™</b>	R&S® DVMD-B1	2068.9406.02
<b>Equipment supplied</b>	3.5" floppy disks with setup program; cable for connecting the R&S® DVMD to the PC, manual and dongle for connection to the parallel printer output of the PC	

## Other features

By switching to offline mode, the current contents of the transport stream can be stored in all operating modes for subsequent analysis.

Stream Explorer™ supports the software interface COM/DCOM (**D**istributed **C**omponent **O**bject **M**odule) which allows data and commands to be exchanged between Windows programs. In networked monitoring systems the Stream Explorer™ can be remote-controlled as an OLE automation server by application software packages.



Contents Overview

Chapter Overview

Type Index

R&S Addresses



## MPEG-2 Monitoring System R&S®DVM100/R&S®DVM120

Transport stream monitoring in diverse DTV distribution networks



MPEG-2 Monitoring System R&S®DVM100

### Brief description

Monitoring complex DTV transmission systems becomes child's play with the R&S®DVM. Its scalability ensures optimum adaptation to the system to be monitored.

The R&S®DVM100 occupies only 1 HU and allows parallel monitoring of either two, three or four transport streams. The R&S®DVM120, also just 1 HU, can be used to expand the R&S®DVM100 up to 12 or 20 (two R&S®DVM120) transport stream inputs. Expansion is in single-channel steps.

The user interface of the R&S®DVM100 provides a concise overview of signal monitoring. The user-defined hierarchical display of the transport stream inputs enables quick navigation. The individual elements of a transport stream are also hierarchically displayed in a tree structure and can thus be easily selected for more in-depth analyses, for example.

The displays described are also used to signal errors by means of coloured symbols, allowing easy and quick error source localization.

The user can classify measurement parameters separately to obtain a quick overview of signalling. Since individual

components can be entirely excluded from monitoring and limit values individually set, the user is not inundated with messages, and the messages are prioritized according to user definitions.

The R&S®DVM system provides a variety of tools for more detailed analyses, including PCR and data rate measurements with comprehensive graphic displays, tables and packet interpreters, and much more.

### Main features

- ◆ Monitoring of up to four transport streams in 1 HU
- ◆ Expandable up to 20 transport streams in 3 HU with the R&S®DVM120
- ◆ Data rates up to 216 Mbit/s
- ◆ Monitoring of TR101290 priorities 1, 2 and 3 (except buffer)
- ◆ Data rate monitoring



R&S®DVM100 (top; left: analyzer board, right: controller) expansion by R&S®DVM120 (below: 2 analyzer boards each), shown with monitor, keyboard and mouse for local operation.

A quick Ethernet interface supports network integration. With SNMP support, the R&S®DVM system can be easily integrated into a central network management system.

The R&S®DVM system is therefore ideal for transport stream monitoring in diverse DTV distribution networks.

- ◆ Single frequency network (SFN) monitoring
- ◆ Comprehensive analysis tools
  - PCR jitter
  - Table/packet interpreter
  - Data rates
  - Table refresh rates
- ◆ 12 user-definable alarm relays
- ◆ Alarm & Event navigator



Contents Overview

Chapter Overview

Type Index

R&S Addresses





Contents Overview

Chapter Overview

Type Index

R&S Addresses



## MPEG-2 Monitoring System R&S®DVM100/R&S®DVM120

- ◆ Local control
  - WindowsXP Embedded
  - XVGA (1024 × 786 pixel) output
  - USB
- ◆ Ethernet 100 Mbit/s
- ◆ System integration via SNMP
- ◆ Concise signalling overview on front panel via multicolour LEDs

### Measurement and analysis functions

In addition to continuous monitoring, optional measurement functions are available (In-Depth Analysis option):

- ◆ **PCR jitter:** For comprehensive PCR jitter measurements; "overall" or "accuracy" measurements can be selected. As with monitoring, the filters used can be set (MGF1 to MGF3). Measurement and filter characteristic comply with the TR 101 290 definition. The measurement results are displayed as a trace
- ◆ **PCR distance:** Graphically displays the distances between the individual PCR values of a program
- ◆ **PTS/PCR difference:** Displays the difference between PTS and PCR in a diagram

### Specifications

You will find detailed and binding data on the enclosed CD (./DATASHEET/DVM.pdf), or, for the latest updates, visit [www.rohde-schwarz.com](http://www.rohde-schwarz.com), search term: DVM100, DVM120

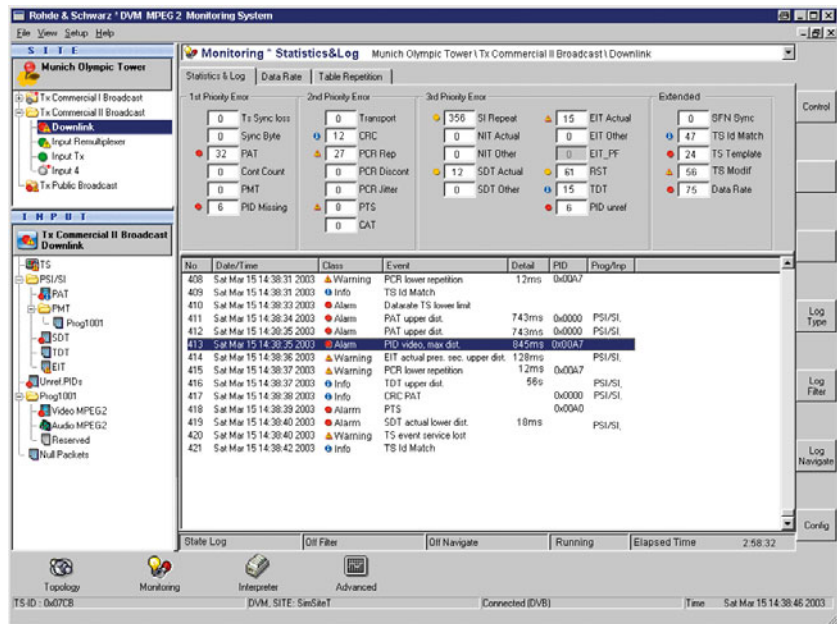

R&S® DVM GUI with report and error counter display.

- ◆ **SI/PSI table interpreter:** Lists all elements of a selected table and interprets the contents
- ◆ **TS packet interpreter:** Displays a transport stream packet in hex format and simultaneously as an interpreted list of contents for the header and the adaptation field
- ◆ **PES header interpreter:** Lists all elements of a selected PES header and interprets the contents
- ◆ **Header map:** Provides an overview of the packet distribution of individual elementary streams, the first four bytes of each transport stream packet being displayed in hex format

### Ordering information

<b>MPEG-2 Monitoring System</b>	R&S®DVM100	2085.1600.02
	R&S®DVM120	2085.1700.02
<b>Hardware option</b>		
Analyzer Board	R&S®DVM-B1	2085.3283.02
<b>Software option</b>		
Additional TS Input	R&S®DVM-K1	2085.5211.02
In-Depth Analysis	R&S®DVM-K10	2085.5228.02
<b>Accessories</b>		
19" Adapter (1 HU)	R&S®ZZA-111	1096.3254.00



Contents Overview

Chapter Overview

Type Index

R&S Addresses





Contents Overview

Chapter Overview

Type Index

R&amp;S Addresses

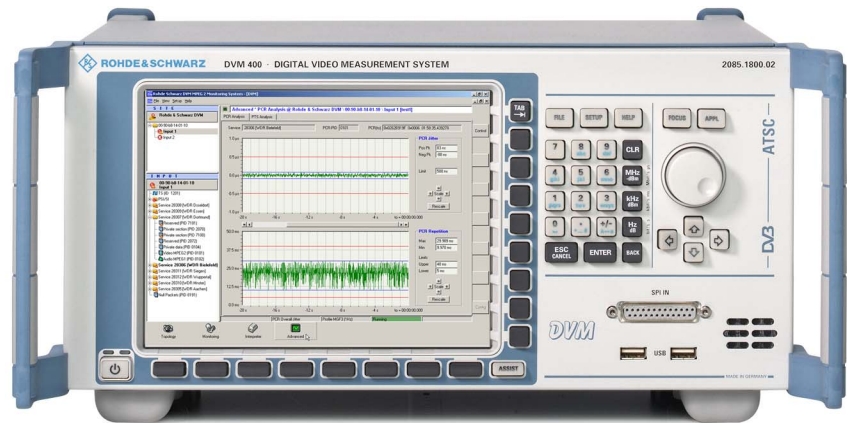

## Digital Video Measurement System R&amp;S® DVM400

**New****Monitoring, analysis, recording and generation of MPEG-2 transport streams****Brief description**

The R&S® DVM400 is a highly compact, portable MPEG-2 platform that offers a wealth of test, analysis and monitoring functions for digital TV. Users require neither a laptop nor an external monitor to operate the system since it comes equipped with an integrated, high-resolution colour display. The system is operated by means of its keys and rotary knob, or via the supplied USB mouse. An external monitor and keyboard can be connected. Versatile options ensure that customer requirements are optimally satisfied. Functions can usually be added simply by installing a software key.

The R&S® DVM400 includes a powerful computer platform with various interfaces and space for three plug-in cards. A broadband recorder and generator board can be installed in the first slot. A fast analyzer board as is used in other systems of the R&S® DVM family is available for the second slot. This board allows parallel monitoring of up to four transport streams. Since both boards function independently of each other, the R&S® DVM400 can be configured either

as a pure recorder and generator or as a pure analyzer. If both boards are installed, special features are available. For example, a recorded signal can be sent directly within the system to the analyzer board for later analysis. Or, if a signal is monitored, the analyzer board can directly trigger the recorder and generator board to perform event-driven recording.

Both boards support a variety of functions, some of which are optionally available. The analyzer board allows not only transport stream monitoring, but also the analysis of data rates, PCR and PTS values, the interpretation of tables and packets plus the analysis of diverse data services.

Various test signals are available for the recorder and generator board. By using the Stream Combiner™ software, users can generate their own transport streams on the R&S® DVM400.

Like the R&S® DVM100, the R&S® DVM400 can be expanded by the R&S® DVM120 to monitor more than four transport streams; parallel monitoring of

up to 20 transport streams is thus possible via the GUI of the R&S® DVM400 (two R&S® DVM120 plus options are required).

**Main features**

- ◆ Transport stream monitoring
  - Monitoring of all TR101290 first, second and third priority parameters (except buffer)
  - Data rate monitoring
  - Single frequency network monitoring
  - Data rates up to 214 Mbit/s
  - Event-controlled transport stream capture function
  - User-definable alarm relays
  - Flexible definition of monitoring parameters
- ◆ Transport stream analysis
  - Data rates
  - PCR and PTS analysis
  - Table/packet interpreter
  - Data broadcast analysis
- ◆ Transport stream generation, recording and replaying
  - Bit rates up to 214 Mbit/s
  - Memory up to 160 Gbyte
  - Extensive test signal library
  - Transport stream generation software



Contents Overview

Chapter Overview

Type Index

R&amp;S Addresses





Contents Overview

Chapter Overview

Type Index

R&amp;S Addresses



## Digital Video Measurement System R&S®DVM400

- ◆ Operating features
  - Event Navigator
  - Assistant
- ◆ Large colour display
- ◆ USB interfaces on front and rear panels
- ◆ Ethernet interface (100 Mbit/s)
- ◆ Simple remote control
- ◆ System integration via SNMP for monitoring applications
- ◆ Flexible option management

### Monitoring functions

Up to four transport streams can be monitored in parallel. One transport stream can be monitored with the analyzer option, another three with one R&S®DVM-K1 option each. In addition to the monitoring functions, numerous analysis functions are available. Analysis can be performed on one of the transport streams at the same time it is being monitored.

Transport streams are monitored in accordance with Measurement Guidelines TR101290. Well over 100 parameters are monitored on each transport stream, including:

- ◆ All first, second and third priority parameters (with the exception of 3.3, buffer)
- ◆ Bit rates of all transport stream elements (different calculation methods according to TR101290 can be selected (MGB1, MGB2 and MGB5 with  $\tau = 5$  s))
- ◆ Availability and contents of the megabyte initialization packet (MIP), used in single frequency networks (SFN)
- ◆ Modification of conditional access information
- ◆ Transport stream modifications (TSID, addition or omission of elements, etc)

### Event navigator

As a special feature, the R&S®DVM400 supports filter functions for the report entries.

- ◆ All entries for a PID (e.g. all entries for PID100 (e.g. video))
- ◆ All entries of the same type (e.g. all entries for an incorrect PMT repetition period)
- ◆ All entries for a PID of the same type

### Analysis functions

Each analysis function can be performed at the same time transport streams are being monitored.

#### In-depth analysis

- ◆ **PCR jitter:** For comprehensive measurement of PCR jitter; selection of one of the two measurements "Overall" or "Accuracy"; setting of the filters used (MGF1 to MGF3) also for monitoring; measurement and filter characteristics as defined in TR101290
- ◆ **PCR distance:** Graphical representation of the distance between individual PCR values of a program
- ◆ **PTS/PCR difference:** Graphical representation of the difference between PTS and PCR
- ◆ **PTS distance:** Graphical representation of the distance between individual PTS values of a program
- ◆ **SI/PSI table interpreter:** Detects a corresponding section in the TS and interprets its contents
- ◆ **TS packet interpreter:** Displays a transport stream packet in hex format and simultaneously as an interpreted list of contents for the header and adaptation field
- ◆ **PES header interpreter:** Lists all header elements of a selected PES and interprets their contents.

- ◆ **Header map:** Provides an overview of the packet distribution of individual elementary streams; displays the first four bytes of each transport stream packet in hex format.

### Data broadcast analysis

A wide scope of analysis functions is available for data broadcast applications. The R&S®DVM400-B1 base option alone provides the following functionalities. All transmission techniques and related applications listed below are recognized and entered in the transport stream elements list under the appropriate designation:

- ◆ DVB object carousel, e.g. for downloading of MHP applications
- ◆ DVB data carousel, e.g. for system software updates (SSU)
- ◆ Multi-protocol encapsulation (MPE), e.g. for IP data transmission
- ◆ Data streaming, e.g. for teletext, subtitles, VPS, WSS and transmission of personal data
- ◆ Data piping, e.g. for transmission of personal data

#### The following tables are also listed

- ◆ Application information table AIT (MHP)
- ◆ IP/MAC notification table INT (IP data via MPE)
- ◆ System software update notification table UNT (SSU)

#### The bit rates of a data service can also be measured by means of the associated PID. In-depth analysis functions:

- ◆ Interpretation of related tables (AIT, INT and UNT)
- ◆ Interpretation of PES headers (data streaming)
- ◆ Interpretation of TS packets (all profiles)



Contents Overview

Chapter Overview

Type Index

R&amp;S Addresses





## Digital Video Measurement System R&S®DVM400

### Overview of all available measurements

	Data piping	Data streaming	MPE	Data carousel	Object carousel
Overview	display of used descriptors and name of tables containing the descriptors				
Interpreter	TS header	PES header	section	section (DSI, DII and DDB header)	
Raw data	TS packet contents	PES packet contents	section contents	DDB section contents	
Timing measurements	<ul style="list-style-type: none"> <li>– ES bit rate</li> <li>– repetition time of payload unit start indicators</li> </ul>	<ul style="list-style-type: none"> <li>– PES bit rate</li> <li>– repetition time of PES header</li> </ul>	<ul style="list-style-type: none"> <li>– bit rate of se-lected section</li> <li>– repetition time of selected section</li> </ul>	<ul style="list-style-type: none"> <li>– bit rate of selected module, DSI, DII section</li> <li>– repetition time of selected DII, DSI section</li> <li>– loading time of selected module</li> </ul>	

### Specifications

You will find detailed and binding data on the enclosed CD

(../DATASHEET/DVM400.pdf), or, for the latest updates, visit [www.rohde-schwarz.com](http://www.rohde-schwarz.com), search term: DVM400

### Overview of options and functions, ordering information

Description	Type	Function	Order No
<b>Base unit</b>			
Base unit	R&S®DVM400	Computer platform <ul style="list-style-type: none"> <li>– motherboard, hard disk, RAM, Windows XP Embedded</li> <li>– colour display, loudspeaker, keys and rotary knob</li> <li>– USB wheel mouse</li> <li>– 3 slots, 2 SPI connectors (input and output), 10 MHz reference input</li> <li>– 12 alarm lines2), trigger input, Ethernet interface</li> <li>– 4 × USB connectors, expansion connector for R&amp;S®DVM120</li> </ul>	2085.1800.02
<b>Analyzer functions</b>			
Analyzer	R&S®DVM400-B1	Analyzer board (4 ASI/310M connectors) <ul style="list-style-type: none"> <li>– unblocking function for one transport stream (TS Input)</li> <li>– monitoring functions</li> <li>– analysis functions: in-depth analysis</li> <li>– event navigator</li> <li>– assistant</li> </ul>	2085.5505.02
Additional TS Input	R&S®DVM-K1	Unblocking function for parallel monitoring of one additional transport stream	2085.5211.02
TS Capture	R&S®DVM-K2	Storage and recording of transport stream sections	2085.5234.02
Data Broadcast Analysis	R&S®DVM-K11	Analysis of data broadcast services	2085.5311.02
<b>Recorder and generator functions</b>			
TS Generator (GTS format only)	R&S®DVM400-B2	Generator board (ASI/310M connectors) <ul style="list-style-type: none"> <li>– support of GTS mode</li> <li>– transport stream generation</li> <li>– test signal library</li> </ul>	2085.5511.02
Upgrade TS Recorder TRP 90 Mbit/s	R&S®DVM400-B3	Hard disk (option R&S®DVM400-B2 required) <ul style="list-style-type: none"> <li>– recording, replaying</li> <li>– bit rates up to 90 Mbit/s (hard disk) and 214 Mbit/s (memory)</li> </ul>	2085.5528.02
Upgrade TS Recorder TRP 214 Mbit/s	R&S®DVM400-B4	Bit rates up to 214 Mbit/s (hard disk and memory) (options R&S®DVM400-B2 and R&S®DVM400-B3 required) <ul style="list-style-type: none"> <li>– doubling of hard disk memory (additional hard disk)</li> </ul>	2085.5534.02
Test Card M Streams	R&S®DV-TCM	Additional test signals	2085.7708.02
HDTV Sequences	R&S®DV-HDTV	Additional test signals	2085.7650.02
Stream Combiner™	R&S®DVG-B1	Offline TS multiplexer software <ul style="list-style-type: none"> <li>– elementary stream library</li> </ul>	2068.9835.02
<b>Recommended extras</b>			
Documentation of Calibration Values	R&S®DVM-DCV		2082.0490.29
Service Manual			2085.1839.02



Contents Overview

Chapter Overview

Type Index

R&S Addresses



## MPEG-2/ATM Test Set R&S® DVATM

**Multifunctional MPEG-2 and ATM test set**



*R&S® DVATM with opened 15"-TFT display*

### Brief description

The R&S® DVATM is a multifunctional MPEG-2 and ATM test set. It is intended for all measurement applications in which MPEG-2 signals are transported over ATM telecommunication interfaces. For all these applications it offers the necessary tools from the MPEG-2 and telecommunication world, providing the required interfaces for all layers involved as well as test signals and analysis functions.

The R&S® DVATM is the first unit worldwide that is able to process both MPEG-2 and ATM signals. The user interface is designed in the style commonly found in sound and TV broadcasting. It gives the user a clear overview of the complex relations and operations at all times.

### Main features

- ◆ Integrated MPEG-2 and ATM test set
- ◆ Compact design
- ◆ Flexible telecommunication interfaces
- ◆ Portable
- ◆ Wide range of test functions
- ◆ Straightforward operating concept

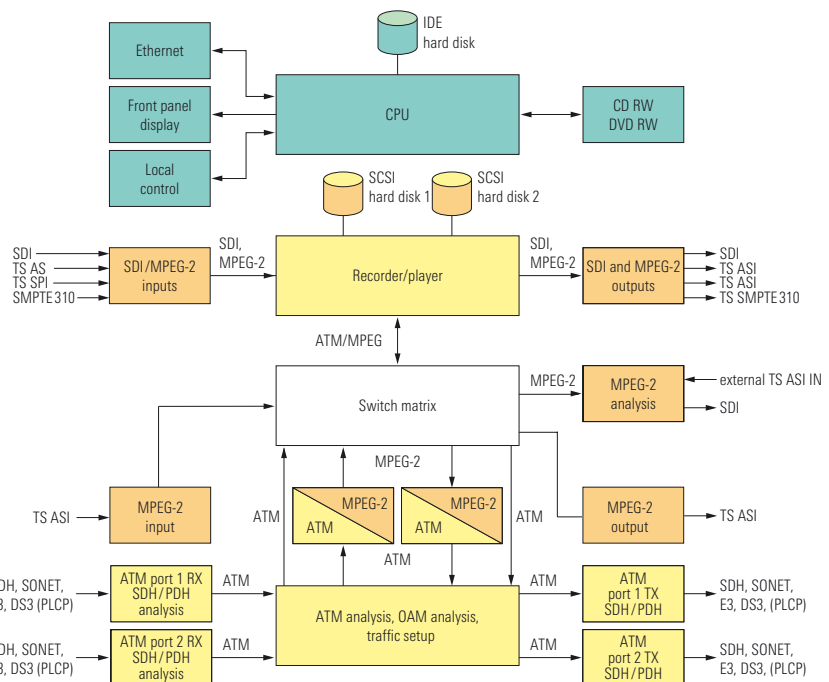

*Measurement at any point of transmission route with R&S® DVATM*



Contents Overview

Chapter Overview

Type Index

R&S Addresses





Contents Overview

Chapter Overview

Type Index

R&S Addresses



## MPEG-2/ATM Test Set R&S® DVATM

### Applications

One application is the installation and startup of transmission routes, network elements, MPEG-2/ATM adapters and SDI encoders. The R&S® DVATM allows bench testing of the entire equipment plus transmission simulation prior to installation. All required settings can be made in advance. This cuts installation and commissioning costs and saves unnecessary field trials on equipment already in place. Testing transmission routes prior to use allows early identification of possible connection problems. This ensures subsequent errorfree transmission, in which the test set can also be used to monitor quality.

In monitoring mode, the R&S® DVATM can log and record data streams of the layers. Used in a network management operation center, the test set can monitor connections under remote control. The user interface of the test set can be exported to any PC over IP networks. In the event of problems, specific path sections can thus be tested and analyzed from a remote location.

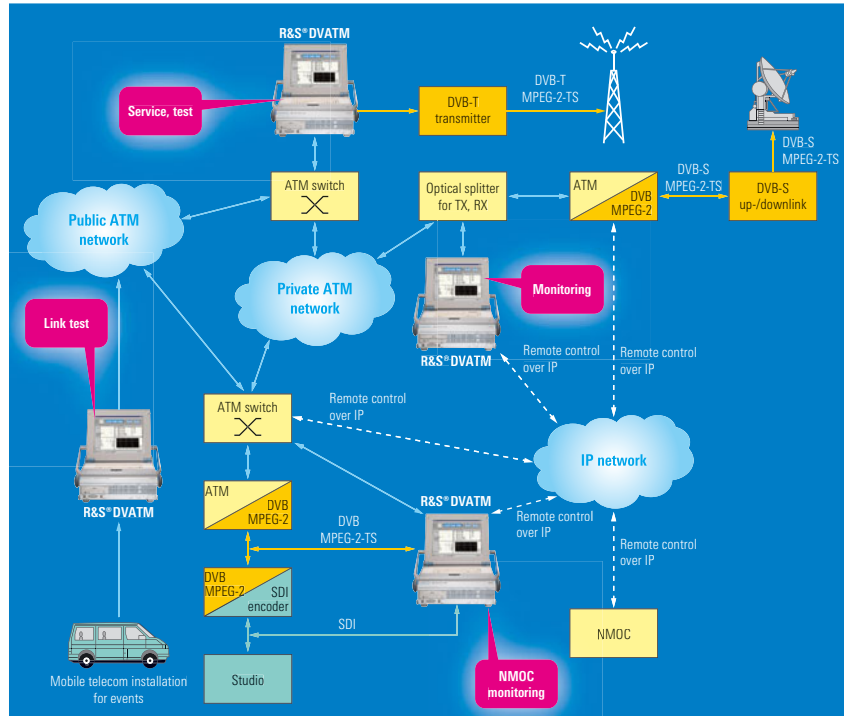

Examples of R&S® DVATM application versatility

### Ordering information

MPEG-2/ATM Test Set	R&S® DVATM	2084.7004.02
(only available in combination with R&S® DVATM-B31 and ATM Interface)		
<b>Options</b>		
ATM Interface SO2	R&S® DVATM-B2	2084.7479.02
ATM Interface SO15	R&S® DVATM-B3	2084.7485.02
ATM Interface TP155	R&S® DVATM-B5	2084.7504.02
ATM Interface E3/DS3	R&S® DVATM-B11	2084.7562.02
Local Control	R&S® DVATM-B20	2084.7440.02
MPEG-2 Analyzer	R&S® DVATM-B30	2084.7591.02
MPEG-2 Generator/Recorder	R&S® DVATM-B31	2084.7604.02
ATM Record/Play	R&S® DVATM-B40	2084.7533.02
SCSI Hard disk 36 GB	R&S® DVRG-B2	2083.1919.02
SDI (ITU-R B.T. 601/656; Record/Play)	R&S® DVRG-B4	2083.1931.02
SMPTE-310M Interface	R&S® DVRG-B6	2083.1954.02
<b>Software</b>		
Test Card M Sequences	R&S® DV-TCM	2085.7708.02
HDTV Sequences	R&S® DV-HDTV	2085.7650.02
Stream Explorer™ (included in R&S® DVATM-B30)	R&S® DVMD-B1	2068.9406.02
Stream Combiner™	R&S® DVG-B1	2068.9835.02



Contents Overview

Chapter Overview

Type Index

R&S Addresses





Contents Overview

Chapter Overview

Type Index

R&S Addresses



## DVD Compendium Professional R&S®TestDVD

**Comprises 5 DVDs with professional test patterns and test data streams for audio, video and EMC applications – particularly designed for use with DVD players and recorders**

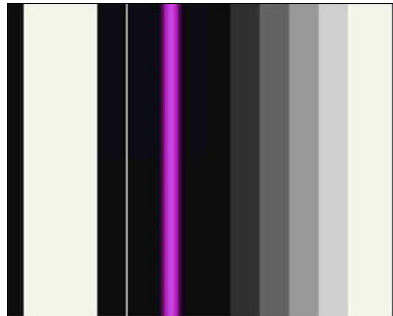

CCIR 17

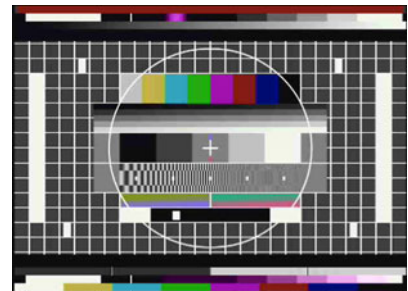

Codec43

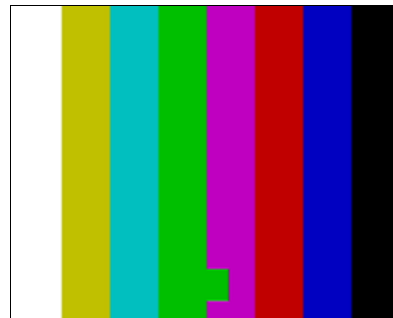

ITU-R BT.801-1 with moving element

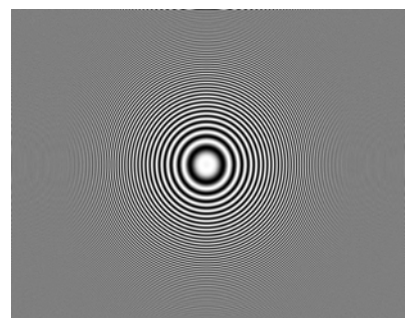

Zone plate

### Brief description

In many cases, measurement quality is determined to a considerable extent by the scope and quality of the available test signals. The DVD compendium offers a unique compilation of many different video and audio streams for professional applications.

### Main features

- ◆ Precompliance measurements on video and audio equipment
- ◆ Objective measurement and assessment of video and audio signals, especially those used in DVD systems (DVD video and DVD audio), for example by means of video analyzers (R&S® UAF, R&S® DVO, R&S® VSA) and audio analyzers (R&S® UPL)

- ◆ Subjective quality tests of video and audio equipment
- ◆ Type approval tests in accordance with international standards, e.g. with EMS Test System R&S® TS9980, to determine electromagnetic susceptibility of sound and TV broadcast receivers as well as satellite and DVB receivers

### Characteristics

The compendium consists of three albums for different types of tests:

- ◆ Album 1 contains more than 150 test patterns, video and audio sequences on a DVD VIDEO including tests for measuring electromagnetic susceptibility

- ◆ Album 2 contains one DVD AUDIO and one DVD VIDEO with stereo and multi-channel test sequences
- ◆ Album 3 comprises two DVDs with data streams for testing the reliability of systems containing DVD components, including automatic error correction tests and endurance tests of DVD equipment

Particular importance was attached to the digital test sequences meeting relevant quality standards. Offering a choice of suitable picture structures and audio frequencies, the test sequences allow standard-conforming measurements of maximum quality as well as the subjective assessment of audio and video equipment.



Contents Overview

Chapter Overview

Type Index

R&S Addresses





Contents Overview

Chapter Overview

Type Index

R&S Addresses



## DVD Compendium Professional R&S®TestDVD

The DVDs also contain special test sequences enabling automatic measurements and evaluation in conjunction with equipment or test systems from Rohde&Schwarz.

For example, the video DVD includes:

- ◆ CCIR 17 test pattern for measuring nonlinearities, level and group-delay errors
- ◆ Codec43 test pattern combining a variety of test signals in one pattern for the simultaneous, automatic measurement of significant parameters of a video signal
- ◆ Test data stream based on ITU-R BT.801-1 including a moving element for the automatic, objective picture assessment with analog and digital degradations

Numerous live video sequences for visual quality assessment are also provided, including:

- ◆ Sequences containing elements with rotating or back-and-forth motion for the assessment of smearing effects on monitors, TFT displays, plasma tubes or projectors as contrasted with conventional TV picture tubes
- ◆ Special video test streams such as zone-plate signals that support the visual assessment of artefacts generated in scaling conversion

The video sequences also contain audio signals ranging from 997 Hz reference signals and pink noise up to AC-3 test signals for the simultaneous and complete assessment of audio and video streams.

The test sequences are provided for PAL or NTSC systems as well as for 4:3 and 16:9 aspect ratios.

The audio signals on the audio DVDs allow the exact measurement of multi-channel frequency response as well as the precise determination of S/N ratios and distortion. In addition, numerous sequences are available for the control of discrete channels, for example to test downmix functions or loudspeaker parameters set in the decoder.

Descriptions of the data streams can be downloaded from the following Internet address:

[www.testdvd.rohde-schwarz.com](http://www.testdvd.rohde-schwarz.com)

The test DVDs are provided by Rohde&Schwarz and Burosch with support from Audiovision and TESTfactory.

### DVDs included

DVD-1, video <sup>1)</sup>	Test patterns and data streams for video and EMC applications
DVD-2 video <sup>1)</sup> , DVD-3 audio	Test sequences for stereo and multichannel systems
DVD-4, video <sup>1)</sup>	Test sequences for laser and error correction measurements
DVD-5, video <sup>1)</sup>	Endurance tests of DVD equipment

<sup>1)</sup> TV standard PAL or NTSC.

### General data

5 DVDs	1 × DVD-9, 4 × DVD-5
Regional code	0
TV standard	PAL or NTSC
Aspect ratio	4:3; 16:9 (not for all test sequences)

### Ordering information

<b>DVD Compendium Professional</b>	R&S®TestDVD	
PAL		1159.6090.02
NTSC		1159.6090.03



Contents Overview

Chapter Overview

Type Index

R&S Addresses



## TV Test Receiver Family R&S®EFA

Test receivers and demodulators for analog and digital (DVB-C, J.83/B, DVB-T or ATSC/8VSB) TV signals

R&S®EFA63



### Brief description

#### DTV

R&S®EFA's powerful digital signal processing provides fast and thorough analysis of the received digitally modulated TV signal. The MPEG-2 transport stream is permanently available for decoding as well as for video and audio reproduction. Due to its real-time analysis capability, the high number of measured values necessary for the complex calculation and display processes are made available for subsequent mathematical/statistical processing in an extremely short and as yet unequalled time. Because of its high-speed data acquisition, the TV Test Receiver R&S®EFA is the ideal choice not only for R&D but also for production environments where short measurement cycles are essential.

#### Analog TV

The analog R&S®EFA models provide high precision demodulated baseband signals (vision and sound) for measurements in various applications (TV transmitters, cable headends, coverage measurements, R&D). At the same time, all relevant RF parameters are monitored at high speed and represented in a logical manner. User-configurable alarm messages permit unattended monitoring of the received signals as well as switchover to alternative links in the event of a failure.

The high-end demodulator version is used for on-site measurements on TV transmitters. This version offers particularly low-distortion demodulation of the broadcast signal. It is perfectly suited for these types of measurements; its low measurement uncertainty permits optimal alignment as well as permanent quality control of transmitters.

### Applications

- ◆ Production of modulators and transmitters (calibration and test)
- ◆ Transmitter installation and adjustment of Single Frequency Networks (SFN in DVB-T)
- ◆ Coverage measurements on terrestrial signals
- ◆ Monitoring of TV transmitters, transposers and cable head-ends
- ◆ Research and development
- ◆ Service
- ◆ Measurement of noise margin of digital signals
- ◆ Monitoring of MPEG-2 transport streams

### Main features

#### Common features

- ◆ Simple, user-friendly operation
- ◆ Modular design easy retrofitting of options
- ◆ Alarm messages for measurement functions, internal storage

- ◆ IEC/IEEE-bus and RS-232-C interface
- ◆ Error report
- ◆ Input of any IF frequency with the aid of the R&S®EFA-B3 option: frequency range continuously tunable from 5 MHz to 1000 MHz
- ◆ Special function: invert spectrum feature (with option R&S®EFA-B3)

#### Standard test receiver

(model .12/40/50/60/70/78/90)

- ◆ Selective receiver
- ◆ Typical use in the field where adjacent channels need to be filtered
- ◆ Excellent price/performance ratio

#### High-end demodulator

(model .33/43/53/63/73/89/93)

- ◆ Wideband input (non-selective receiver), tunable
- ◆ Typically used for transmitter testing
- ◆ Outstanding SNR, excellent intermodulation characteristics
- ◆ High-end synthesizer with extremely low phase noise

**High-end test receiver (model .33/43/53/63/73/89/93 + option R&S®EFA-B3)**

- ◆ Outstanding SNR and improved intermodulation characteristics
- ◆ Rejection of image frequency and IF
- ◆ Two additional selective RF inputs (50  $\Omega$  and 75  $\Omega$ )
- ◆ Extended frequency range from 4.5 MHz to 1000 MHz



Contents Overview

Chapter Overview

Type Index

R&S Addresses



## Test Receiver Family R&S®EFA – The family members, specific features

### DTV

Model	Description	Features
40	DVB-T Test receiver	selective
43	DVB-T Test demodulator	broadband
50	ATSC/8VSB Test receiver	selective
53	ATSC/8VSB Test demodulator	broadband
60	DVB-C Test receiver	selective
63	DVB-C Test demodulator	broadband
70	ITU-T J.83/B Test receiver (US cable)	selective
73	ITU-T J.83/B Test demodulator (US cable)	broadband

### Analog TV

Model	Description	Features
12	Analog TV Test receiver	standard B/G, selective
33	Analog TV Test demodulator	standard B/G, broadband
78	Analog TV Test receiver	standard D/K or I, selective
89	Analog TV Test demodulator	standard D/K or I, broadband
90	Analog TV Test receiver	standard M/N NTSC/BTSC, selective
93	Analog TV Test demodulator	standard M/N NTSC/BTSC, broadband

### Specific features

#### DVB-T

DVB-T Test Receiver R&S®EFA, fully compatible with the EN300744 standard, receives, demodulates, decodes and analyzes OFDM (orthogonal frequency division multiplex) signals.

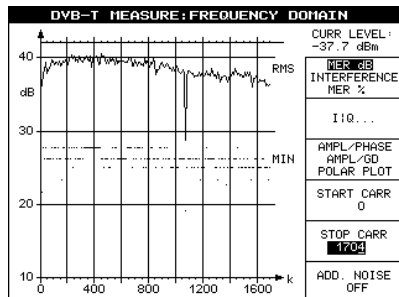

**MER as a function of the frequency is one of the most powerful measurements that the R&S®EFA can perform. It displays the MER for every QAM modulated carrier of the OFDM signal. At a glance, the overall quality of the transmitter under test can be measured.**

**With 'START CARR' and 'STOP CARR', any impaired QAM carrier in the OFDM signal can be quickly located. Co-channel interference can also be measured and displayed when an interference measurement is performed (interference-to-carrier measurement).**

All key parameters for demodulating the receive signal can be selected automatically or manually:

- ◆ 6, 7 or 8 MHz operating bandwidth
- ◆ 2K or 8K OFDM modulation
- ◆ QPSK, 16QAM or 64QAM
- ◆ Constellation diagram
- ◆ 1/2, 2/3, 3/4, 5/6 or 7/8 code rate
- ◆ 1/4, 1/8, 1/16 or 1/32 guard interval
- ◆  $\alpha = 1, 2$  or 4 hierarchical demodulation
- ◆ Reed-Solomon error correction 204/188
- ◆ 6, 7z or 8 MHz SAW filter bandwidth (selectable)
- ◆ General measurement functions for
  - RF input level
  - Carrier frequency offset
  - Bit rate offset
  - BER (before Viterbi, before and after Reed-Solomon)
- ◆ In-depth measurement capabilities
  - OFDM parameter analysis
  - MER analysis over frequency
  - Q analysis over frequency
  - Frequency domain analysis (channel estimation)
  - Time domain analysis (impulse response and amplitude distribution)
  - History function

- ◆ Integrated noise generator for measurement of noise margin
- ◆ MPEG-2 transport stream output (serial or parallel)

#### DVB-C

Fully compatible with the DVB-C standard (EN300429), the R&S®EFA 60/63 models receive, demodulate, decode and analyze all orders of QAM (Quadrature Amplitude Modulated) signals.

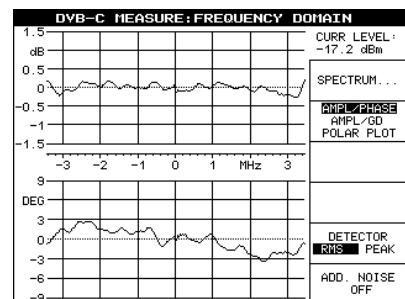

**The coefficients of the equalizer are used to display the amplitude and phase frequency response (shown here), the group delay (not shown here) and the polar plot representation.**

**The polar plot representation — which is the complex representation of amplitude and phase — may help to interpret very short echoes that are difficult to visualize on the echo pattern display.**



Contents Overview

Chapter Overview

Type Index

R&S Addresses





Contents Overview

Chapter Overview

Type Index

R&S Addresses



## Test Receiver Family R&S®EFA – Specific features

All key parameters for demodulating the received signal can be automatically or manually selected:

- ◆ 6, 7 or 8 MHz bandwidth
- ◆ 4, 16, 32, 64, 128 or 256QAM modulation
- ◆ Variable symbol rate for special modulator tests and lab analysis (1 Msymbol/s to 6.999 Msymbol/s)
- ◆ Reed-Solomon error correction 203/187/8
- ◆ Optional SAW filter bandwidths: 6, 7, 8 MHz and 2 MHz
- ◆ General measurement functions for
  - RF input level
  - Carrier frequency offset
  - Bit rate offset
  - BER (before and after Reed-Solomon)
- ◆ In-depth measurement capabilities
  - QAM parameter analysis
  - Constellation diagram (including histogram function)
  - Eye monitoring
  - Frequency domain analysis (from equalization)
  - Spectrum analysis (including automatic shoulder attenuation measurement)
  - Time domain analysis (Echo pattern and amplitude distribution)
  - History function
- ◆ Integrated noise generator for measurement of noise margin
- ◆ Special function: invert spectrum feature
- ◆ MPEG-2 transport stream output (serial or parallel)

### ATSC/8VSB

The ATSC/8VSB Test Receiver R&S®EFA, fully compatible with the ATSC Doc. A/53 standard, receives, demodulates,

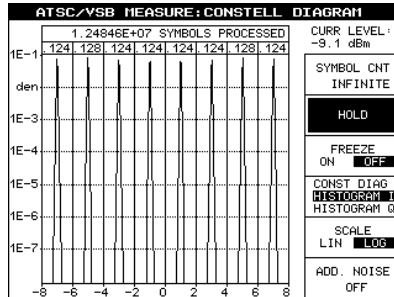

*Histogram I represents the distribution of the eight-level vestigial sideband modulation (8VSB) on the X axis, and can be expressed in a linear or logarithmic scale.*

*It allows an estimate of the interferer's origin (interferer, Gaussian noise, etc).*

*Hint: Check the position of the sync pulse ( $\pm 5$ ), and check the impact on the distribution.*

decodes and analyzes 8VSB (eight-level vestigial sideband) signals. All key parameters for demodulating the received signal can be automatically or manually selected:

- ◆ 8VSB modulation
- ◆ Trellis decoder (code rate 2/3)
- ◆ Fixed symbol rate for normal use (10.762238 Msymbol/s)
- ◆ Variable symbol rate for special modulator tests and lab analysis (2 Msymbol/s to 11 Msymbol/s)
- ◆ Reed-Solomon error correction 207/187/10
- ◆ Optional SAW filter bandwidths: 6 MHz, 8 MHz and 2 MHz
- ◆ General measurement functions for
  - RF input level
  - Carrier frequency offset
  - Bit rate offset
  - BER (before and after Reed-Solomon)
- ◆ In-depth measurement capabilities
  - 8VSB parameter analysis
  - Constellation diagram (including histogram function)

- Eye monitoring
- Frequency domain analysis (from equalization)
- Spectrum analysis (including automatic shoulder attenuation measurement according to FCC rec.)
- Time domain analysis (Ghost pattern and amplitude distribution)
- History function
- ◆ Integrated noise generator for measurement of noise margin
- ◆ MPEG-2 transport stream output (serial or parallel)
- ◆ Additional SMPTE310M MPEG-2 transport stream output

### ITU-T J.83/B (US cable)

Fully compatible with the ITU-T J.83/B standard, the R&S®EFA 70/73 models receive, demodulate, decode and analyze 64QAM or 256QAM (quadrature amplitude modulated) signals.

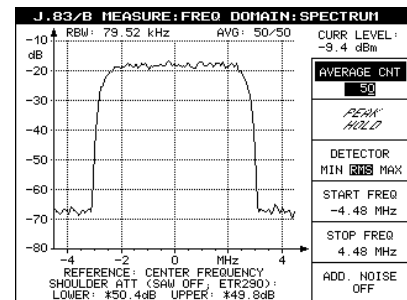

*Thanks to this integrated feature, a separate spectrum analyzer is not required anymore.*

*All basic spectrum analyzer functions are provided: start/stop frequency (or center/span) and several detection and averaging modes.*

All key parameters for demodulating the received signal can be automatically or manually selected:

- ◆ 64QAM or 256QAM modulation
- ◆ Trellis decoder (code rate 14/15 for 64QAM and 19/20 for 256QAM)



Contents Overview

Chapter Overview

Type Index

R&S Addresses







Contents Overview

Chapter Overview

Type Index

R&S Addresses



## Test Receiver Family R&S®EFA – Specific features

- ◆ Fixed symbol rate for normal use (5.056941 Msymbol/s for 64QAM and 5.360537 Msymbol/s for 256QAM)
- ◆ Variable symbol rate for special modulator tests and lab analysis (1 Msymbol/s to 6999 Msymbol/s)
- ◆ Reed-Solomon error correction 128/122/3
- ◆ Optional SAW filter bandwidth: 6 MHz, 8 MHz and 2 MHz
- ◆ General measurement functions for
  - RF input level
  - Carrier frequency offset
  - Bit rate offset
  - BER (before and after Reed-Solomon)
- ◆ In-depth measurement capabilities
  - QAM parameter analysis
  - Constellation diagram (including histogram function)
  - Eye monitoring
  - Frequency domain analysis (from equalization)
  - Spectrum analysis (including automatic shoulder attenuation measurement)
  - Time domain analysis (Ghost pattern and amplitude distribution)
  - History function
- ◆ Integrated noise generator for measurement of noise margin
- ◆ MPEG-2 transport stream output (serial or parallel)

### Analog TV

Fully compatible with analog standards, the analog R&S®EFA models receive and demodulate the analog TV standards B/G, D/K and I.

NYOU FM MEASURE			
SET RF	CHANNEL	ATTEN : 15 dB	STANDARD
503.25 MHz	25	84.2 dBuV	B/G
<b>VISION CARRIER:</b>			
LEVEL		84.2 dBuV	
SET RF	503.250000 MHz		
MEASURED RF	503.250000 MHz		
CONTROLLED RF	503.250000 MHz		
VIDEO LEVEL		100 %	
<b>SOUND CARRIER:</b>			
VISION/SOUND1 CARRIER RATIO		12.9 dB	
VISION/SOUND2 CARRIER RATIO		20.1 dB	
INTERCARRIER1 FREQUENCY	5.5345 MHz		
INTERCARRIER2 FREQUENCY	5.7476 MHz		
FM DEVIATION SOUND1	27.2 kHz		
FM DEVIATION SOUND2	31.2 kHz		
FM DEVIATION PILOT AVERAGE	2.54 kHz		
PILOT FREQUENCY	54.888 kHz		
PILOT		DUAL SOUND	

*All parameters for the demodulated standard B/G TV channel are displayed on a single screen and can be checked at a glance:*

- Vision carrier level
- Video modulation depth
- Sound intercarrier measurements
- Vision/sound level ratio
- Sound 1 & 2 FM deviation
- Pilot decoding

All key parameters for demodulating the received signal can be automatically or manually selected:

- ◆ Switchable group delay correction
- ◆ Switchable synchronous detector (5 different modes)
- ◆ Demodulation using intercarrier method
- ◆ Balanced audio outputs
- ◆ Measurement functions for
  - vision/sound carrier spacing (level and frequency)
  - FM sound carrier and pilot deviation
  - RPC (Residual Picture Carrier) or video modulation depth

### Analog TV standard M/N NTSC/BTSC

Fully compatible with the FCC standard, the R&S®EFA 90/93 models receive and demodulate any analog TV signals to standard M/N (NTSC/BTSC and PAL).

NTSC/BTSC MEASURE			
SET RF	CHANNEL	ATTEN : 20 dB	STANDARD
61.25 MHz	3	90.7 dBuV	M/N
<b>VISION CARRIER:</b>			
LEVEL		90.7 dBuV	
MODULATION DEPTH		68.9 %	
BAR AMPLITUDE		79.2 IRE	
SYNC AMPLITUDE		31.0 IRE	
VIDEO AMPLITUDE		110.2 IRE	
<b>SOUND CARRIER:</b>			
VISION / SOUND CARRIER RATIO		12.9 dB	
FM DEVIATION MAIN CHANNEL		31.1 kHz	
FM DEVIATION BTSC CHANNEL		44.8 kHz	
FM DEVIATION MTS PILOT		5.38 kHz	
MULTICHANNEL TV SOUND		STEREO + SAP	

*All parameters for the demodulated standard M/N TV channel are displayed on a single screen and can be checked at a glance:*

- Vision carrier level
- Video modulation depth
- Bar/sync/video amplitudes (expressed in IRE)
- Vision/sound level ratio
- Main and BTSC channel FM deviation
- FM deviation of MTS pilot
- Sound mode indication (Mono, Stereo, SAP)

All key parameters for demodulating the received signal can be automatically or manually selected:

- ◆ Switchable group delay correction
- ◆ Switchable envelop or synchronous detector (5 different modes)
- ◆ Demodulation using intercarrier or split carrier method
- ◆ Integrated BTSC/MTS decoder
- ◆ Balanced audio outputs
- ◆ Measurement functions for
  - vision/sound carrier spacing (level)
  - FM sound carrier and MTS pilot deviation
  - RPC (Residual Picture Carrier) or video modulation depth



Contents Overview

Chapter Overview

Type Index

R&S Addresses





Contents Overview

Chapter Overview

Type Index

R&S Addresses



## Test Receiver Family R&S®EFA – Options overview

Option	Description
<b>Hardware</b>	
NICAM demodulator/decoder (R&S®EFA-B2)	<ul style="list-style-type: none"> <li>Demodulation and decoding of signals to NICAM-728 standard</li> <li>Measurement parameters: bit error ratio, eye height, clock and data jitter</li> <li>I and Q signal output</li> </ul>
MPEG-2 decoder (R&S®EFA-B4)	<ul style="list-style-type: none"> <li>Real-time analysis to ETR 101290</li> <li>Error report</li> <li>Video and audio output</li> </ul>
Video distributor (R&S®EFA-B6)	<ul style="list-style-type: none"> <li>2 video outputs on front panel, 2 video outputs on rear panel</li> <li>1 additional Q output on front panel</li> </ul>
Switchable sound trap (R&S®EFA-B7)	<ul style="list-style-type: none"> <li>Only available for standard B/G (R&amp;S®EFA models .12/33)</li> <li>Allows video bandwidth measurements up to 6 MHz</li> </ul>
OFDM demodulator (R&S®EFA-B10)	<ul style="list-style-type: none"> <li>Option for analog R&amp;S®EFA models</li> <li>DVB-T demodulation, according to EN 300 744</li> </ul>
6 MHz SAW filter (R&S®EFA-B11)	<ul style="list-style-type: none"> <li>Adjacent-channel rejection</li> <li>Meets US requirements</li> </ul>
7 MHz SAW filter (R&S®EFA-B12)	<ul style="list-style-type: none"> <li>Designed to DVB-T standards</li> <li>Adjacent-channel rejection</li> <li>Meets European and Australian standards</li> </ul>
8 MHz SAW filter (R&S®EFA-B13 model .02)	<ul style="list-style-type: none"> <li>Designed to DVB-T standards</li> <li>Adjacent-channel rejection</li> <li>Meets European standards</li> </ul>
8 MHz SAW filter (R&S®EFA-B13 model .03)	<ul style="list-style-type: none"> <li>Adjacent-channel rejection</li> <li>Meets European and US standards, recommended for spectrum measurement</li> </ul>
2 MHz SAW filter (R&S®EFA-B14)	<ul style="list-style-type: none"> <li>Adjacent-channel rejection</li> <li>Meet channel return requirements</li> </ul>
Digital demodulator platform (R&S®EFA-B20)	<ul style="list-style-type: none"> <li>Upgrade for analog R&amp;S®EFA models</li> <li>Supporting DVB-C demodulation (with option R&amp;S®EFA-K21), ATSC/8VSB demodulation (with option R&amp;S®EFA-K22), ITU-T J.83/B demodulation (with option R&amp;S®EFA-K23)</li> <li>Included in basic R&amp;S®EFA 50/53/60/63/70/73 models</li> </ul>
<b>Software</b>	
DVB-C firmware (R&S®EFA-K21)	<ul style="list-style-type: none"> <li>Analysis, demodulation and monitoring of DVB-C signals according to EN 300 429 standard</li> <li>Included in basic R&amp;S®EFA 60/63 models</li> </ul>
ATSC/8VSB firmware (R&S®EFA-K22)	<ul style="list-style-type: none"> <li>Analysis, demodulation and monitoring of ATSC/8VSB signals according to ATSC Doc. A/53</li> <li>Included in basic R&amp;S®EFA 50/53 models</li> <li>Additional SMPTE310M MPEG-2 transport stream output</li> </ul>
ITU-T J.83/B firmware (R&S®EFA-K23)	<ul style="list-style-type: none"> <li>Analysis, demodulation and monitoring of American digital cable signals according to ITU-T J.83/B standard</li> <li>Included in basic R&amp;S®EFA 70/73 models</li> </ul>
FIR coefficient readout firmware (R&S®EFA-K25)	<ul style="list-style-type: none"> <li>Output of FIR coefficients of the equalizer</li> <li>Available for R&amp;S®EFA 50/53 or option R&amp;S®EFA-B20 with R&amp;S®EFA-K22</li> <li>Coefficient file transfer via RS-232-C interface</li> </ul>
M/N NTSC/BTSC demodulator (R&S®EFA-B30)	<ul style="list-style-type: none"> <li>Meets FCC requirements (group delay correction)</li> <li>Switchable sound trap</li> <li>Switchable group delay correction</li> <li>Switchable synchronous or envelope detector</li> <li>Integrated BTSC/MTS decoder</li> </ul>



Contents Overview

Chapter Overview

Type Index

R&S Addresses



## TV Test Receiver Family R&S® EFA – Specifications, ordering information

### Specifications

You will find detailed and binding data on the enclosed CD (./DATASHEET/EFA.pdf), or, for the latest updates, visit [www.rohde-schwarz.com](http://www.rohde-schwarz.com), search term: EFA

### Ordering information

#### DTV

<b>DVB-T Test Receiver<sup>1)</sup></b>		
Selective, constellation diagram, output MPEG-2 data stream	R&S®EFA40	2067.3004.40
<b>DVB-T Test Demodulator<sup>1)</sup></b>		
Broadband, constellation diagram, output MPEG-2 data stream	R&S®EFA43	2067.3004.43
<b>ATSC/8VSB Test Receiver<sup>1)</sup></b>		
Selective, constellation diagram output MPEG-2 data stream	R&S®EFA50	2067.3004.50
<b>ATSC/8VSB Test Demodulator<sup>1)</sup></b>		
Broadband, constellation diagram, output MPEG-2 data stream	R&S®EFA53	2067.3004.53
<b>DVB-C Test Receiver<sup>1)</sup></b>		
Selective, 4/16/32/64/128/256QAM, output MPEG-2 data stream, constellation diagram	R&S®EFA60	2067.3004.60
<b>DVB-C Test Demodulator<sup>1)</sup></b>		
Broadband, 4/16/32/64/128/256QAM, output MPEG-2 data stream, constellation diagram	R&S®EFA63	2067.3004.63
<b>ITU-T J.83/B Test Receiver<sup>1)</sup></b>		
Selective, 4/16/32/64/128/256QAM, output MPEG-2 data stream, constellation diagram	R&S®EFA70	2067.3004.70
<b>ITU-T J.83/B Test Demodulator<sup>1)</sup></b>		
Broadband, 4/16/32/64/128/256QAM, output MPEG-2 data stream, constellation diagram	R&S®EFA73	2067.3004.73

<sup>1)</sup> Note: please fill in configuration sheet (available from your local representative) so that your test receiver/demodulator can be tailored to your requirements.

#### ANALOG TV

<b>TV Test Receiver<sup>1)</sup></b>		
Standard B/G, dual sound, IF 38.9 MHz, RF 45 MHz to 860 MHz, selective	R&S®EFA12	2067.3004.12
<b>TV Test Demodulator<sup>1)</sup></b>		
Standard B/G, dual sound, IF 38.9 MHz, RF 45 MHz to 1000 MHz, broadband	R&S®EFA33	2067.3004.33

<b>TV Test Receiver<sup>1)</sup></b>		
Standard D/K, or I (mono), IF 38.9 MHz, RF 45 MHz to 860 MHz, selective	R&S®EFA78	2067.3004.78
<b>TV Test Demodulator<sup>1)</sup></b>		
Standard D/K or I (mono), IF 38.9 MHz, RF 45 MHz to 1000 MHz, broadband	R&S®EFA89	2067.3004.89
<b>TV Test Receiver<sup>1)</sup></b>		
Standard M/N, mono, selective, RF 45 MHz to 860 MHz, IEEE bus	R&S®EFA90	2067.3004.90
<b>TV Test Demodulator<sup>1)</sup></b>		
Standard M/N (mono), broadband, RF 45 MHz to 1000 MHz, IEEE bus	R&S®EFA93	2067.3004.93

<sup>1)</sup> Note: please fill in configuration sheet (available from your local representative) so that your test receiver/demodulator can be tailored to your requirements.

<b>Accessories supplied</b>	Lemo Triax adapter to XLR stereo (only when audio signals are available), power cable, operating manual	
-----------------------------	---	--

<b>Options</b>		
NICAM Demodulator Std. B/G, D/K	R&S®EFA-B2	2067.3610.02
NICAM Demodulator Standard I	R&S®EFA-B2	2067.3610.04
RF Selection for Demodulator	R&S®EFA-B3	2067.3627.02
MPEG-2 Decoder	R&S®EFA-B4	2067.3633.02
Video Distributor	R&S®EFA-B6	2067.3656.02
Switchable Sound Trap (only R&S®EFA12/33)	R&S®EFA-B7	2067.3710.02
COFDM Demodulator (for analog TV units)	R&S®EFA-B10	2067.3740.02
Digital Demodulator Platform (for analog TV units)	R&S®EFA-B20	2067.3585.02
Std. M/N Demodulator (for digital units)	R&S®EFA-B30	2067.3556.02
6 MHz SAW Filter (for digital units)	R&S®EFA-B11	2067.3691.00
7 MHz SAW Filter (for digital units)	R&S®EFA-B12	2067.3591.00
8 MHz SAW Filter (for DVB-T digital units)	R&S®EFA-B13	2067.3579.02
8 MHz SAW Filter (for DVB-C/ATSC/J83/B units)	R&S®EFA-B13	2067.3579.03
2 MHz SAW Filter (for digital units)	R&S®EFA-B14	2067.3562.00
DVB-C Firmware (for R&S®EFA5x/7x or R&S®EFA-B20)	R&S®EFA-K21	2067.4000.02
ATSC/8VSB Firmware (for R&S®EFA6x/7x or R&S®EFA-B20)	R&S®EFA-K22	2067.4017.02
J.83/B Firmware (for R&S®EFA5x/6x or R&S®EFA-B20)	R&S®EFA-K23	2067.4023.02
FIR Coefficient Readout Firmware (for R&S®EFA5x or R&S®EFA-B20 and R&S®EFA-K22)	R&S®EFA-K25	2067.4046.02
<b>Extras</b>		
Measurement Software EFA-SCAN	R&S®EFA-K1	2067.9202.02
R&S®EFA Calibration values	R&S®EFA-DCV	2082.0490.09
R&S®EFA-B4 Calibration values	R&S®EFA-DCV	2082.0490.15
19" Adapter	R&S®ZZA-93	0396.4892.00
Lemo Triax connector (mono) with connecting cable (open)		2067.7451.00
Service manual	R&S®ERST.2	2068.0950.24
Bag for units 19", 3 HU, depth 460 mm	R&S®ZZT-314	1001.0523.00



Contents Overview

Chapter Overview

Type Index

R&S Addresses



## Measurement Software EFA-SCAN R&S®EFA-K1



User Field	Channel 32	Channel 33	Channel 34	Channel 35	Channel 36	Channel 37
Center Frequency (MHz)	394,0000000	402,0000000	410,0000000	418,0000000	426,0000000	434,0000000
Symbol Rate (MSymb/s)	6,9000000	6,9000000	6,9000000	6,9000000	6,9000000	6,9000000
Status	Done	Done	Done	Done	Done	Done
Time Stamp	24.06.2003 15:40:27	24.06.2003 15:42:52	24.06.2003 15:45:18	24.06.2003 15:47:34	24.06.2003 15:50:00	24.06.2003 15:52:24
RF Level (dBm)	-56,6	-57,3	-57,4	-51,1	-57,6	-57,7
Frequency Offset (Hz)	-421,6	926,5	-475,8	---	-935,9	277,8
Symbol Rate Offset (Hz)	5	0,8	3	---	12,1	3,2
BER before RS	0,00E+00 (391/1000)	1,40E-09 (390/1000)	0,00E+00 (392/1000)	---	0,00E+00 (388/1000)	0,00E+00 (386/1000)
BER after RS	0,00E+00 (401/1000)	0,00E+00 (399/1000)	0,00E+00 (402/1000)	---	0,00E+00 (397/1000)	0,00E+00 (395/1000)
Packet Err Ratio	0,00E+00 (401/1000)	0,00E+00 (403/1000)	0,00E+00 (402/1000)	---	0,00E+00 (401/1000)	0,00E+00 (395/1000)
Packet Err / s	0	0	0	---	0	0
TS Bitrate (Mbit/s)	38,153	38,153	38,153	---	38,153	38,153
10 MHz Ref Sync	OK	OK	OK	OK	OK	OK
Carrier Loop Sync	OK	OK	OK	UNSYNC	OK	OK
MPEG TS Sync	OK	OK	OK	UNSYNC	OK	OK
Ampl. Response (dB)	1,03	1,5	1,41	---	0,83	1,05
Phase Response (°)	9,5	9,4	8,9	---	8,9	8,5
Group Delay (µs)	0,0765	0,0709	0,0708	---	0,0573	0,0668
Shoulder Lower (dB)	---	---	---	---	---	---
Shoulder Upper (dB)	---	---	---	---	---	---
Crest Factor - Margin (dB)	12,8	12,8	12,8	12,2	12,8	12,8
Crest Factor - Max (dB)	11,2	11,2	11,2	11	11,3	11,3
Crest Factor - Current (dB)	11,2	11,2	11,2	11	11,3	11,3
Echo Pattern Attn. 1 (dB)	-36,7	---	---	---	---	---
Echo Pattern Delay 1 (µs)	0,59	---	---	---	---	---
Echo Pattern Attn. 2 (dB)	---	---	---	---	---	---
Echo Pattern Delay 2 (µs)	---	---	---	---	---	---
I/Q Ampl. Imbal. (%)	0,01	0,01	0	---	0	0
I/Q Quad. Error (°)	0	0	0	---	0	0
Carrier Suppression (dB)	>60	>60	>60	---	>60	>60
Phase Jitter (° RMS)	0,17	0,16	0,12	---	0,22	0,15
S/N (dB)	33,9	33,4	33,8	---	30,5	33,5
MER (dB RMS)	33,6	33,1	33,4	---	30,2	33,2
Sync Errors (%)	0,0	0,0	0,0	100,0	0,0	0,0

FIG 1: Table for displaying the measurement values (in this case, R&S®EFA6x)

### Fast recording and documentation of measurement values for the digital Test Receivers R&S®EFA

### Brief description

Recording entire measurement sequences (e.g. at a cable headend) can be very time-consuming, which means that users immediately start looking for a solution that will save them time and effort. Such a solution has now been developed specifically for the digital models .2x, .4x, .5x, .6x and .7x of the R&S®EFA test receiver family – it is called R&S®EFA-K1.

The software runs on any PC under Windows98/NT/2000 or XP. The connection between the PC and the Test Receiver R&S®EFA can be set up via the RS-232-C interface or the IEC/IEEE bus. Another option is the use of a terminal server to establish the connection via LAN/WAN (FIG 2).



Contents Overview

Chapter Overview

Type Index

R&S Addresses



## Measurement Software EFA-SCAN R&amp;S®EFA-K1

## Main features

- ◆ Repeated measurements in any number of loops
- ◆ Run mode (frequency scan)
- ◆ Snapshot mode
- ◆ Saving of measurement values to a file
- ◆ Use for R&S®EFA2x/4x/5x/6x/7x
- ◆ PC connection via RS-232-C, IEC/IEEE bus or TCP/IP
- ◆ For Windows98/NT/2000 and XP

## Operation

The sequence of registers in the entry dialog specifies the steps that need to be carried out one after the other. After the interface and model have been selected, a dialog window appears for defining the measurement task at hand. First, the default setting of the receiver is determined, e.g. bandwidth, SAW filter or signal input.

In the next step, the user must enter the frequencies at which the measurements are to be performed. The measurement parameters are then defined in a list that depends on the model and standard. The user can decide for each measurement

parameter whether the measurand is only to be displayed and/or also stored to a file.

## Two measurement modes

The measurements are started at a key-stroke. Two modes are offered: In the Snapshot mode, the previously defined frequency list is processed just once; in the Run mode, it is cyclically performed

until the measurements are explicitly stopped. The measurement values thus obtained are displayed in tables for each frequency (FIG 1).

The measurement values to be stored are saved in CSV format (comma-separated values) which is a commonly used file format enabling data to be ported to Excel or a database, for example.

**FIG 2: Connecting options between PC and R&S®EFA.**

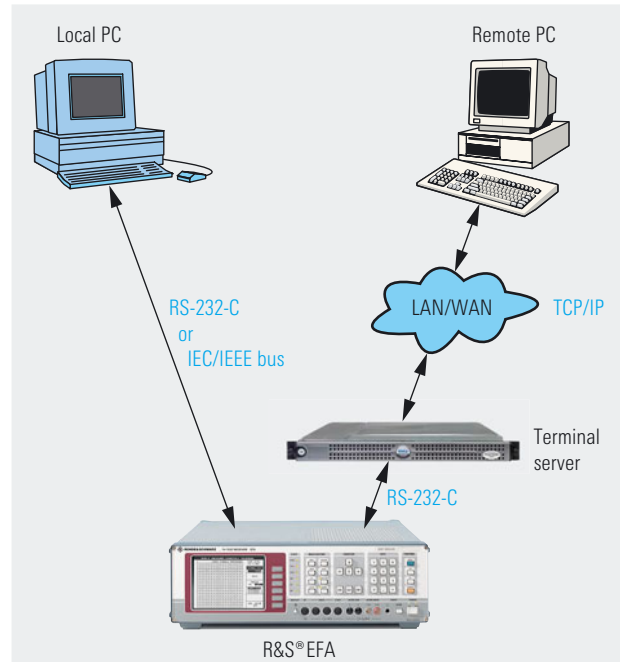

## Specifications

**You will find detailed and binding data on the enclosed CD (../DATASHEET/EFA-K1.pdf), or, for the latest updates, visit [www.rohde-schwarz.com](http://www.rohde-schwarz.com), search term: EFA-K1**

## Ordering information

Measurement Software EFA-SCAN	R&S®EFA-K1	2067.9202.02
-------------------------------	------------	--------------



Contents Overview

Chapter Overview

Type Index

R&S Addresses



## Portable SAT/TV/FM Test Receiver R&S®EFL 100

**Measurement features for analog TV, digital TV and FM radio in a single unit**

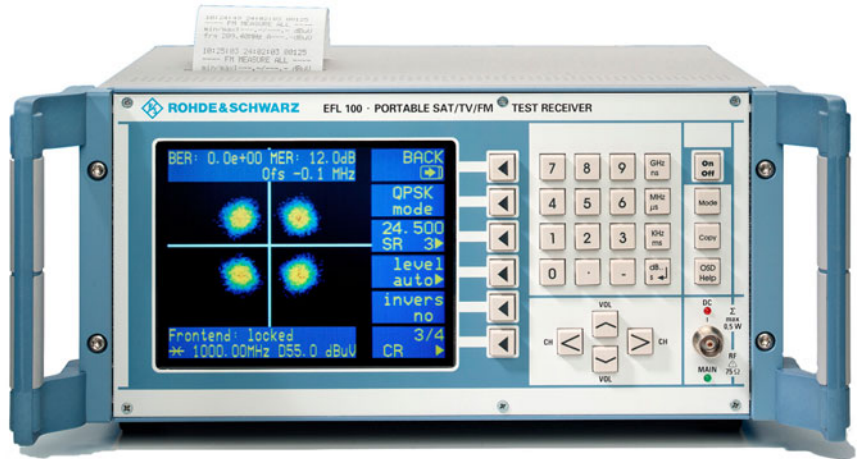

### Brief description

A cost-efficient, mobile solution for installing, checking and maintaining transmitters, antennas and signal distribution equipment is needed. The Test Receiver R&S®EFL 100 meets all requirements. In many cases, the R&S®EFL 100 is also the ideal complement to a high-end TV test receiver used for more in-depth signal analysis.

Depending on the specific requirements, users can choose between three models. With the fully equipped model .04 of the R&S®EFL 100, detailed quality measurements of DVB-C, DVB-S and DVB-T signals can be carried out along with level measurements of analog and digital TV, FM radio and satellite reception signals.

### Main features

- ◆ Easily portable due to compact, robust design and integrated battery
- ◆ User-friendly interface for fast measurements
- ◆ Built-in printer for documentation of measurement results and spectrum
- ◆ On-screen TV picture
- ◆ Control signals for LNBs of satellite antennas

### All models at a glance

	Model .02	Model .03	Model .04
<b>Equipment</b>	Basic model, analog	Model .02 + QAM/QPSK	Model .03 + DVB-T
Analog TV/FM basic module	✓	✓	✓
QPSK/QAM module		✓	✓
DVB-T module			✓
MPEG-2 decoder module		✓	✓
Return path module		✓	✓
MPEG-2 TS parallel output		✓	✓
SCART connector	✓	✓	✓
Modem connector	✓	✓	✓
Earphone connector	✓	✓	✓
12 V DC input		✓	✓
LNB control	✓	✓	✓
<b>Features</b>			
Signal level min./max.	✓	✓	✓
S/N measurement (video)	✓	✓	✓
NICAM audio	✓	✓	✓
Spectrum representation via monitor and printer	✓	✓	✓
Scope function	✓	✓	✓
DVB carrier level	✓	✓	✓
BER		✓	✓
MER		✓	✓
Constellation diagram		✓	✓
Analog TV program on screen	✓	✓	✓
DVB program on screen (free TV)		✓	✓
Memory for 100 settings	✓	✓	✓
Teletext	✓	✓	✓
Date and time	✓	✓	✓



Contents Overview

Chapter Overview

Type Index

R&S Addresses





Contents Overview

Chapter Overview

Type Index

R&S Addresses



## Portable SAT/TV/FM Test Receiver R&S®EFL 100

### Description

The R&S®EFL 100 has been developed for the standards B/G, D/K, I, L, M, N, M Korea, M Japan and NICAM. The video signal can be processed and reproduced in line with the colour TV standards PAL, SECAM and NTSC.

Four different detectors for peak, average, maximum and minimum values are available for level measurements of analog and digital signals. Correction values are determined by the level calibration of the R&S®EFL 100 and stored in a memory. This allows precise level measurements to be performed with the R&S®EFL 100.

The front-panel display provides a bargraph that helps the user to locate transmitters. In addition, a level-dependent acoustic tracking signal simplifies antenna alignment without requiring a look at the screen.

The LNB (low-noise block) supply voltage is 10 V DC to 20 V DC for max. 500 mA in increments of 0.1 V DC. For control of the receiving system, the 22 kHz signal as well as the commands for DiSEqC 2.0, UFO $\mu$ -DiSEqC or V-SEC can be produced.

Level values, frequencies and the entire frequency spectrum can be printed out via the integrated dot-matrix printer.

The R&S®EFL 100 comes with a built-in battery. The battery is rechargeable via the integrated power supply unit.

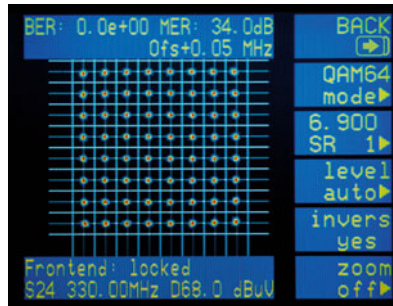

Constellation diagram of a QAM64 signal

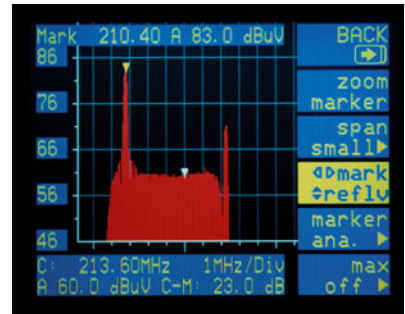

RF spectrum of an analog TV signal

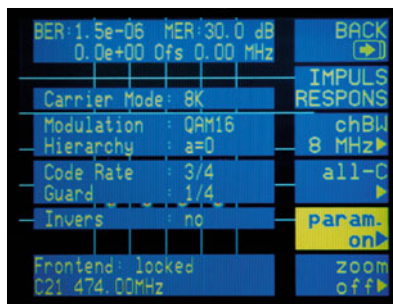

OFDM parameters

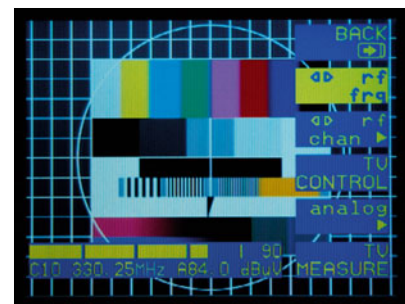

On-screen TV picture

### Specifications

You will find detailed and binding data on the enclosed CD (./DATASHEET/EFL100.pdf), or, for the latest updates, visit [www.rohde-schwarz.com](http://www.rohde-schwarz.com), search term: EFL100

### Ordering information

Portable SAT/TV/FM Test Receiver		
Analog	R&S®EFL 100	2111.2055.02
Analog, DVB-C, DVB-S, MPEG-2, Return path	R&S®EFL 100	2111.2055.03
Analog, DVB-C, DVB-S, DVB-T, MPEG-2, Return path	R&S®EFL 100	2111.2055.04
<b>Options</b>		
Measuring Amplifier with FM Filter	R&S®EFL 100-Z3	2111.2132.02
Measuring Amplifier	R&S®EFL 100-Z4	2111.2149.02
<b>Extras</b>		
Leather Bag	R&S®EFL 100-Z1	2111.2103.00
Antiglare Device	R&S®EFL 100-Z2	2111.2110.00



Contents Overview

Chapter Overview

Type Index

R&S Addresses



## CCVS+Component Generator R&amp;S®SAF, CCVS Generator R&amp;S®SFF

**R&S®SAF:****CCVS,  $Y_C C_B C_R$ , RGB, S-VHS****R&S®SFF: CCVS**

**Multi-standard generators for all TV applications; optionally PALplus and ITU-R BT. 601**

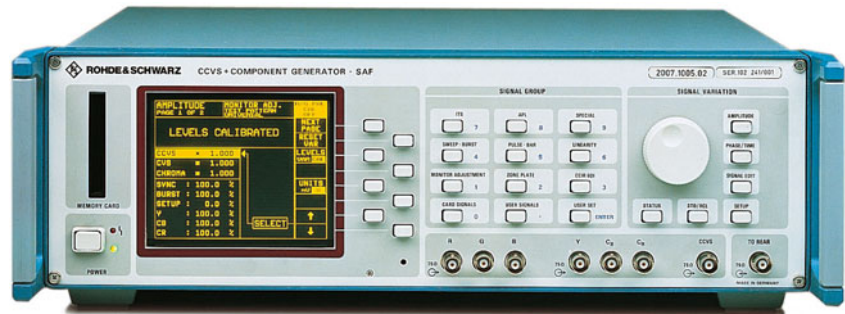
**R&S®SAF****Brief description**

TV Generators R&S®SAF and R&S®SFF are two multistandard instruments (B G/PAL, M/NTSC, M/PAL, N/PAL) suitable for all applications in the field of television. CCVS+Component Generator R&S®SAF are applied to three D/A converters. An analog matrix converts the three components into the RGB format. Therefore the RGB signals are made available simultaneously with the  $Y_C C_B C_R$  components. The digital CCVS in R&S®SAF and R&S®SFF is determined from the  $Y_C C_B C_R$  components in realtime with the aid of two LSI gate arrays.

R&S®SAF and R&S®SFF also generate all test signals to ITU-R Rec. 801, a number of common pathological test signals, and shallow ramps with a resolution of 10 bits. The PALplus test pattern option provides all PALplus reference signals and the bits required for wide screen signalling (WSS).

Both generators afford extensive signal variations via softkey-controlled menus. Such amplitude and phase adjustments of signal components enable testing of gain controls, white-level limiting circuits and video analyzers over the whole range of the devices. User-specific signals can be defined by front-panel entry and stored in the generator or on a memory card.

**Function**

The generator section is of digital design. A transputer – a high-speed RISC processor – calculates the three components  $Y$ ,  $C_B$  and  $C_R$  of all test signals which in CCVS+Component Generator R&S®SAF are applied to three D/A converters. An analog matrix converts the three components into the RGB format. Therefore the RGB signals are made available simultaneously with the  $Y_C C_B C_R$  components. The digital CCVS in R&S®SAF and R&S®SFF is determined from the  $Y_C C_B C_R$  components in realtime with the aid of two LSI gate arrays.

**Digital Video Interface R&S®SAF-Z1**

The optional Digital Video Interface R&S®SAF-Z1 upgrades the R&S®SAF and R&S®SFF for use in digital TV studios. In addition to the analog video signals, a parallel and two serial digital video signals are thus simultaneously available.

**Main features**

- ◆ Clear menu-guided operation on large-size EL display
- ◆ 12 signal groups with up to 8 signal menu pages each; each page may contain 7 signals
- ◆ Superposition of hum, sweep, noise or other signals with different clamping modes

- ◆ APL and bounce signals with preselectable parameters
- ◆ Insertion of external test signals such as teletext or data lines
- ◆ Free programming of test-line coding and monitoring
- ◆ Entry of texts as source identification or scrolling text
- ◆ Program monitoring + substitution pattern
- ◆ System compatibility and full remote control capability (IEC625/IEEE488 bus)
- ◆ Definition of customer-specific signals by "Signal Edit" via the front panel
- ◆ Zone-plate signals, 8 coefficients freely selectable





Contents Overview

Chapter Overview

Type Index

R&amp;S Addresses



## CCVS+Component Generator R&amp;S®SAF, CCVS Generator R&amp;S®SFF

## Specifications

You will find detailed and binding data on the enclosed CD (../DATASHEET/SAF.pdf), or, for the latest updates, visit [www.rohde-schwarz.com](http://www.rohde-schwarz.com), search term: SAF, SFF

## Ordering information

<b>CCVS+Component Generator</b>	R&S®SAF	2007.1005.02
<b>CCVS Generator</b>	R&S®SFF	2007.1057.02
<b>Options</b>		
Digital Video Interface	R&S®SAF-Z1	2007.1063.02
	R&S®SFF-Z1	2007.1063.03
PALplus Test Pattern for R&S®SAF and R&S®SFF	R&S®SAF-B20	2007.1011.02
Calibration Data Documentation	R&S®SAF-DCV	2082.0490.02
	R&S®SAF-DCV	2082.0490.03
<b>Extras</b>		
32 kbyte Memory Card	R&S®ZM-32	2005.4394.02
512 kbyte Memory Card	R&S®ZM-512	2005.4388.02
Service Kit	R&S®SAF-Z	2007.1111.00
	R&S®SFF-Z	2007.1105.00



Contents Overview

Chapter Overview

Type Index

R&amp;S Addresses



## TV Test Transmitter R&amp;S®SFM

5 MHz to 1000 MHz

Vision and sound signals

for all common analog AM TV standards

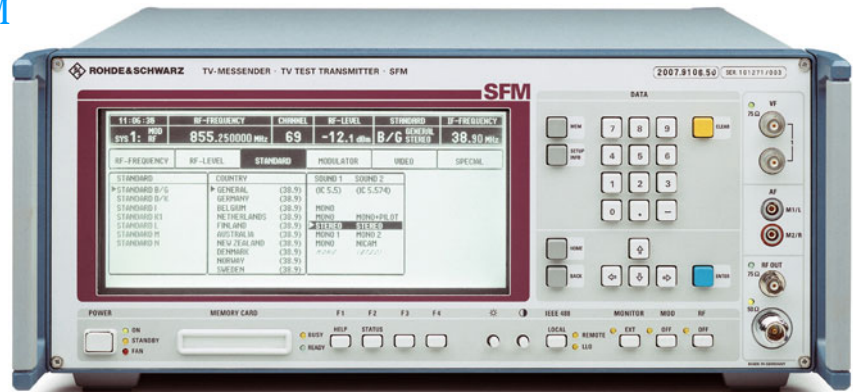

## Brief description

TV Test Transmitter R&S®SFM supplies vision and sound signals to all common TV standards for the IF (32 MHz to 46 MHz) and RF ranges (5 MHz to 1000 MHz).

Thanks to a very flexible modular concept based on plug-ins, R&S®SFM is the compact solution for all analog applications in development, production and servicing. Each R&S®SFM frame can accommodate up to ten plug-ins so that standards B/G, D/K, I, L/L', M and N can be implemented in a single R&S®SFM.

R&S®SFM is ideal for use in EMC measurements: In Europe, EMC requirements are set down in special regulations and laws. Full compliance with prescribed limits is a prerequisite for certification with the European conformity mark CE.

For the American BTSC method, a multiplex signal with a frequency of up to 120 kHz can be applied. The frequency

deviation and output level of the sound carriers are also set automatically as per standard.

Many parameters for the vision, NICAM and sound modulators can be set to non-standard values. The display outputs a warning that non-standard parameters are being used; however, compliance with the appropriate standard can be restored with a single keystroke.

## Main features

- ◆ Generation of TV signals to standards B/G, D/K, I, L/L', M and N, including stereo/dual sound and digital sound (NICAM)
- ◆ Double-sideband test modulator for all IFs between 32 MHz and 46 MHz
- ◆ Internal audio generator, stereocoder and NICAM generator
- ◆ High frequency resolution of 1 Hz for precision offset
- ◆ Frequency locking for all oscillators

## Operation

R&S®SFM outputs all information on a large LCD graphics display; if required an external monitor can be connected. The display is divided into different areas. The currently valid key setting parameters are displayed in the top half, these being frequency, TV channel, output level and the selected standard with the associated vision IF. Below there is the main selection line with menus such as frequency, level and standard. A special menu enables intermodulation measurements and sweep mode to be selected.

R&S®SFM is equipped with an IEC/IEEE-bus interface to SCPI and an RS-232-C interface. Thanks to a PC card interface, complete setups can be loaded from or to a memory card. Software updates can be carried out via the serial interface or memory-card interface.



Contents Overview

Chapter Overview

Type Index

R&amp;S Addresses



## TV Test Transmitter R&amp;S®SFM

## Specifications

You will find detailed and binding data on the enclosed CD (../DATASHEET/SFM.pdf), or, for the latest updates, visit [www.rohde-schwarz.com](http://www.rohde-schwarz.com), search term: SFM

## Ordering information

TV Test Transmitter		
Basic Unit with vision modulator and FM modulator sound 1, without upconverter	R&S®SFM	2007.9106.10
Basic Unit with vision modulator and FM modulator sound 1, with upconverter 5 MHz to 1000 MHz, 50 Ω	R&S®SFM	2007.9106.50
Basic Unit with upconverter 5 MHz to 1000 MHz, 50 Ω, without vision/sound modulator	R&S®SFM	2007.9106.90
Options		
Multistandard Plug-In	R&S®SFM-B7	2008.0248.02
Sound Modulator 2 (switchable FM/AM), including dual-sound coder (IRT)	R&S®SFM-B9	2008.0183.02
QPSK Sound Modulator for NICAM 728 with internal NICAM generator	R&S®SFM-B10	2008.0302.02
RF Output 75 Ω (switchable)	R&S®SFM-B16	2007.9212.02



Contents Overview

Chapter Overview

Type Index

R&amp;S Addresses





Contents Overview

Chapter Overview

Type Index

R&S Addresses



## TV Test Transmitter R&S®SFL

5 MHz to 1.1 GHz/3.3 GHz

Digital signals for use in production



TV Test Transmitter R&S®SFL

### Brief description

The TV Test Transmitter Family R&S®SFL is a complete solution for testing digital TV receivers and integrated receiver modules, as well as for testing digital TV links for broadcasting via terrestrial antennas and cable. It covers all main standards currently used worldwide as well as those to be introduced soon.

The standard-conformant test signals exhibit a high level of precision. To determine the full functionality and the performance of your products at their limits, the test signal parameters can be varied within a wide range and provided with predefined errors. Realistic transmission/reception conditions can be reproducibly simulated with the aid of the noise generator option.

- ◆ Different optimized models:
  - R&S®SFL-T for standard DVB-T
  - R&S®SFL-V for standard ATSC/8VSB
  - R&S®SFL-I for standard ISDB-T (Japan)
  - R&S®SFL-C for standard DVB-C
  - R&S®SFL-J for standard ITU-T/J.83B (US cable)
  - R&S®SFL-S for standard DVB-S, DVB-DSNG

- ◆ Antenna DVB-T
  - 2K- and 8K-COFDM
  - 6 MHz, 7 MHz and 8 MHz
  - QPSK, 16QAM, 64QAM
- ◆ Antenna ATSC
  - 8VSB
- ◆ Antenna ISDB-T
  - mode 1, 2, 3 (2K, 4K, 8K)
  - max. 3 layer (A, B, C)
  - 13 segments per layer (selectable)
- ◆ Cable DVB-C
  - 16-, 32-, 64-, 128-, 256-QAM
- ◆ Cable ITU-T/J.83B (US cable)
  - 64 QAM, 256 QAM
  - Data interleaver level 1 and level 2
- ◆ Satellite DVB-S, DVB-DSNG
  - QPSK
  - 8PSK
  - 16-QAM

### Main features

- ◆ Wide frequency range 5 MHz to 1.1 GHz or 3.3 GHz
- ◆ Large level range for transmission and receiver measurements
- ◆ Wear-free electronic attenuator
- ◆ Fast setting times
- ◆ Operating parameters modifiable
- ◆ Special signals and error signals
- ◆ Sweep mode for frequency and level
- ◆ Status menu for overview of settings
- ◆ Storage of instrument settings
- ◆ List function for automatic command sequence, e.g. measurement of frequency and amplitude response
- ◆ Online help
- ◆ IEC625/IEEE bus, RS-232-C
- ◆ Software update via RS-232-C

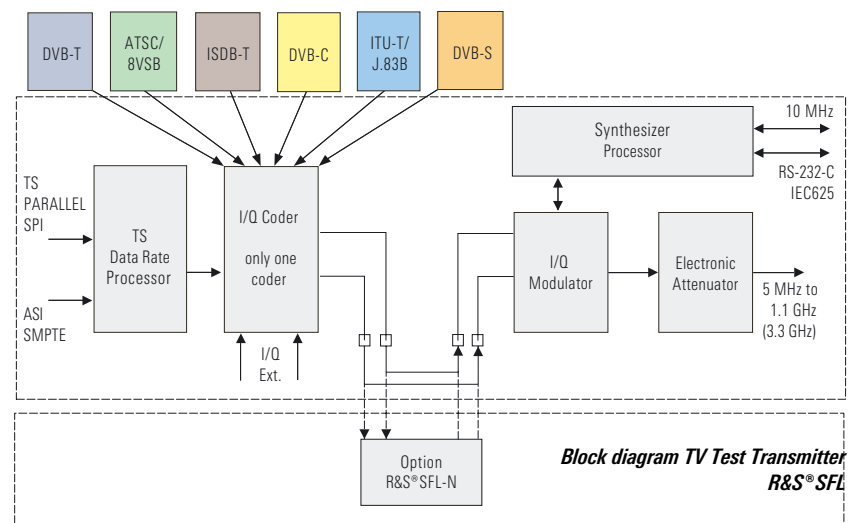

Contents Overview

Chapter Overview

Type Index

R&S Addresses





Contents Overview

Chapter Overview

Type Index

R&S Addresses



## TV Test Transmitter R&S®SFL

### Applications

The high signal quality and the versatile parameter variation capabilities make the R&S®SFL family ideally suited as a standard signal generator for use in production environments. The wide output frequency range allows testing beyond the limits defined by the relevant standard. The benefit of the large level range is that, on the one hand, the functional limits of LSI circuits can be quickly determined and recorded during production; on the other hand, it is easy to simulate a receive link for a TV receiver.

The operating parameters (e.g. roll-off, puncturing, QPSK mode, QAM mode, pilot level, interleaver level, etc) can easily be varied even beyond the limits defined by the relevant standard.

A number of special signals or signals with predefined errors are provided in order to determine the true functional limits or to quickly detect malfunctions; it is also possible to switch off signal characteristics defined in the standard or partial signal functions (e.g. modulation, individual carriers and groups of carriers, pilot, etc).

Irrespective of the model, a sweep mode is available for the total frequency range, as well as an external I/Q input for signals with external coding.

### Specifications

You will find detailed and binding data on the enclosed CD (./DATASHEET/SFL.pdf), or, for the latest updates, visit [www.rohde-schwarz.com](http://www.rohde-schwarz.com), search term: SFL

### Ordering information

TV Test Transmitter		
DVB-S/-DSNG	R&S®SFL-S	2084.4005.10
DVB-C	R&S®SFL-C	2084.4005.15
DVB-T	R&S®SFL-T	2084.4005.20
ATSC/8VSB	R&S®SFL-V	2084.4005.30
J.83/B	R&S®SFL-J	2084.4005.40
ISDB-T	R&S®SFL-I	2084.4005.50
Options		
Noise Generator	R&S®SFL-N	on request
BER Measurement	R&S®SFL-K17	on request
Extras		
Documentation of R&S®SFL Calibration Values	R&S®SFL-DCV	2082.0490.22
Service Kit		2084.4340.02
Service Manual		2084.4128.24
19" Adapter for rackmounting	R&S®ZZA-211	1096.3260.00
Matching Pads 50 Ω/75 Ω		
Matched at both ends, attenuation 5.7 dB, no DC isolation	R&S®RAM	0358.5414.02
Matched at one end, attenuation 1.7 dB	R&S®RAZ	0358.5714.02
Case (2 HU)	R&S®ZZT-214	1109.5119.00



Contents Overview

Chapter Overview

Type Index

R&S Addresses





Contents Overview

Chapter Overview

Type Index

R&amp;S Addresses



## TV Test Transmitter R&amp;S®SFQ

0.3 MHz to 3.3 GHz

Digital signals for antenna,  
satellite and cable

TV Test Transmitter R&amp;S®SFQ

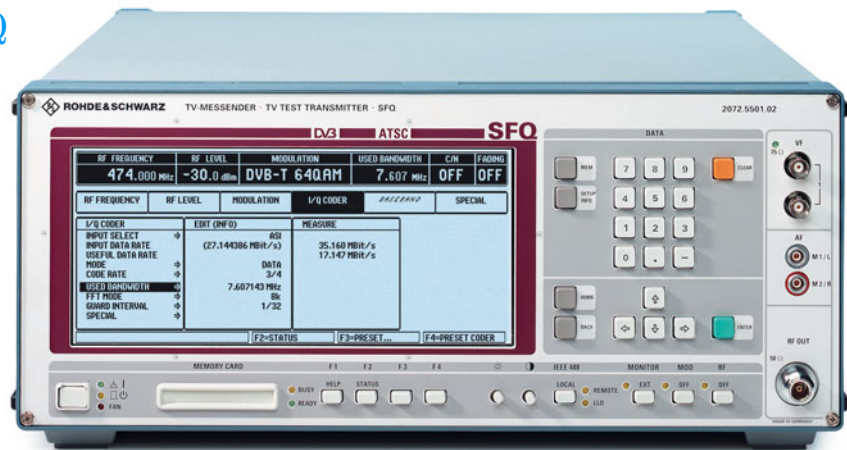

## Brief description

TV Test Transmitter R&S®SFQ is a complete solution for testing digital TV links and receivers (set-top boxes). An open-end software system and modular hardware configuration make for future-proofness. The ETSI standards for DVB-T, DVB-S, DVB-DSNG and DVB-C as well as the ATSC/8VSB and ITU-T/J.83B (US cable) standard for DTV are fully complied with. Thanks to its adaptability to future system changes, R&S®SFQ is a useful and rewarding investment for your launch onto the digital TV market.

Moreover, R&S®SFQ also processes analog frequency-modulated satellite signals in line with PAL, SECAM, NTSC standards. The sound signals are transmitted using analog FM and digital ADR sound subcarriers.

The test signals produced are of high precision and comply with the standards, but can also be varied over a wide range and provided with predefined errors to determine the performance of your products at their limits. The reproducible simulation of real transmission conditions by means of the noise generator and the fading simulator enables the specification of modules under test.

## Main features

- ◆ Wide output frequency range from 0.3 MHz to 3300 MHz
- ◆ Large output level range for transmission, receiver and module measurements
- ◆ Standard DVB, ATSC, ITU-T/J.83B signals and FM satellite signals
- ◆ Several standards in one unit
- ◆ Satellite FM
  - PAL, SECAM, NTSC
  - FM and ADR sound subcarrier
- ◆ Antenna DVB-T
  - 2K and 8K COFDM
  - 6/7/8 MHz bandwidth
  - Hierarchical coding
- ◆ Antenna ATSC
  - 8VSB
- ◆ Cable DVB-C
  - Selectable QAM (quadrature amplitude modulation):  
16, 32, 64, 128, 256QAM
- ◆ Satellite DVB-S, DVB-DSNG, Turbo coder
  - QPSK, QPSK Turbo
  - 8PSK, 8PSK Turbo
  - 16QAM
- ◆ Internal noise generator for high-precision C/N settings
- ◆ Internal bit error measurement (BE) for all digital modulation modes (DVB-C, DVB-S, DVB-DSNG, Turbo coder, DVB-T, 8VSB)

- ◆ Internal fading simulator
  - 6 or 12 paths
  - Predefined profiles
  - User-definable profiles
- ◆ Flexible input interfaces
  - ASI
  - SPI
- ◆ Output and input for external I/O signals

## Other features

- ◆ Symbol rate 0.1 to 80 MSymbol/s
- ◆ Energy dispersal, Reed-Solomon coder and interleaver selectable
- ◆ Variable roll-off factor of pulse shaping
- ◆ Data, pseudo random bit sequence (PRBS) and null transport stream packets as modulation signal selectable
- ◆ Output level: -99 dBm to +4 dBm (CW: +13 dBm)
- ◆ Error simulation with I/Q modulation by means of defined signal distortion

## Applications

Because of its high signal quality and versatile ways of varying parameters, R&S®SFQ is ideal as a source for digital terrestrial signals (DVB-T and ATSC), for testing satellite (DVB-S, DVB-DSNG, Turbo coder and FM) and digital cable links (DVB-C), as a standard-signal generator in development, as a reference in



Contents Overview

Chapter Overview

Type Index

R&amp;S Addresses





Contents Overview

Chapter Overview

Type Index

R&amp;S Addresses



## TV Test Transmitter R&S®SFQ

quality monitoring, EMC labs, inspection and test centers and for use in production.

The output frequency range allows R&S®SFQ to be used as a back-channel generator and covers future extensions of the satellite IF range.

Operational parameters (e.g. roll-off, puncturing rate or QAM mode) can easily be varied. For laboratory applications, values outside those defined in the standard can be selected. For special measurements, it is possible to switch off i.e. interleaver, FEC, modulation, individual carriers or groups of carriers. Sweeps can be performed over the complete RF range.

The analog R&S®SFQ supplies frequency-modulated satellite signals conforming to standards. Various TV standards can be selected, and up to six sound subcarriers (FM and ADR) can be integrated. In addition, external sound subcarriers can be applied. Operational parameters are in line with standards; parameters such as amplitude, frequency and deviation are variable. Signals such as noise or energy dispersal can be added. It is thus possible to test satellite links and receivers using standard signals and to check the response to nonstandard signals.

### Equipment and options

**The basic model .02 of R&S®SFQ has to be ordered with at least one coder option, i.e. with**

- ◆ R&S®SFQ-B10 for DVB-T
- ◆ R&S®SFQ-B21 for DVB-C
- ◆ R&S®SFQ-B23 for DVB-S, DVB-DSNG and Turbo coder
- ◆ R&S®SFQ-B12 for ATSC/8VSB
- ◆ R&S®SFQ-B13 for ITU-T/J.83B (US cable)
- ◆ R&S®SFQ-B2 for FM Modulation

#### DVB/VSF options

- ◆ DVB-T coder
- ◆ DVB-S, DVB-DSNG, Turbo coder
- ◆ DVB-C coder
- ◆ Hierarchical coding for DVB-T coder
- ◆ ATSC/8VSB coder
- ◆ ITU-T/J.83B coder (US cable)
- ◆ Noise generator
- ◆ Fading simulator (6 or 12 paths)
- ◆ Input interface (ASI; selectable symbol rate, precise data clock)
- ◆ BER
- ◆ I/Q output/input

### Specifications

**You will find detailed and binding data on the enclosed CD**

**(../DATASHEET/SFQ.pdf), or, for the latest updates, visit [www.rohde-schwarz.com](http://www.rohde-schwarz.com), search term: SFQ**

#### Optional broadband FM modulator

- ◆ FM satellite signals to standard
- ◆ Standard for FM transmission selectable (PAL, SECAM, NTSC)
- ◆ FM sound subcarriers with internal audio generators (two sound subcarriers installed as standard)
- ◆ Input for external sound subcarriers
- ◆ Input for external FM
- ◆ Baseband output
- ◆ Option: additional FM sound subcarriers
- ◆ Option: ADR (Astra Digital Radio) sound subcarrier with internal MUSICAM generators
- ◆ Noise generator



Contents Overview

Chapter Overview

Type Index

R&amp;S Addresses





Contents Overview

Chapter Overview

Type Index

R&S Addresses



## TV Test Transmitter R&S®SFQ

### Ordering information

TV Test Transmitter (0.3 MHz to 3300 MHz) for		
DVB-C	R&S®SFQ.02+ R&S®SFQ-B21	2072.5501.02 2072.8912.02
DVB-S/-DSNG	R&S®SFQ.02+ R&S®SFQ-B23	2072.5501.02 2072.5830.02
DVB-T, 2K/8K	R&S®SFQ.02+ R&S®SFQ-B10	2072.5501.02 2072.6166.02
ATSC/8VSB	R&S®SFQ.02+ R&S®SFQ-B12	2072.5501.02 2072.6220.02
ITU-T, J.83B (US cable)	R&S®SFQ.02+ R&S®SFQ-B13	2072.5501.02 2072.6243.02
Broadband FM	R&S®SFQ.02+ R&S®SFQ-B2	2072.5501.02 2072.6108.02
<b>Options</b>		
Please state serial number of unit when submitting new orders for options.		
Input Interface (ASI/SPI input and selectable symbol rate, SMPTE310 input), can be retrofitted	R&S®SFQ-B6	2072.7679.03
DVB-T Coder, 2K/8K COFDM Modulator, 6 MHz/7 MHz/8 MHz bandwidth (for R&S®SFQ delivered before 1999 see R&S®SFQ-B18)	R&S®SFQ-B10	2072.6166.02
DVB-T/Hierarchical Coding	R&S®SFQ-B16	2072.5782.02
ATSC Coder, 8VSB (HW + FW)	R&S®SFQ-B12	2072.6220.02
ITU-T/J.83B (FW)	R&S®SFQ-B9	2072.6143.02
ITU-T/J.83B Coder (HW + FW)	R&S®SFQ-B13	2072.6243.02
ATSC/8VSB (FW)	R&S®SFQ-B8	2072.6120.02
DVB-C Coder (HW + FW)	R&S®SFQ-B21	2081.8912.02
DVB-C (only FW)	R&S®SFQ-B22	2072.5824.02
DVB-S/-DSNG Coder (HW + FW)	R&S®SFQ-B23	2072.5830.02
DVB-S/-DSNG (only FW)	R&S®SFQ-B24	2072.5847.02
I/Q Output/Input	R&S®SFQ-B14	2072.6266.02

Power Supply Upgrade for R&S®SFQ model .10, delivered before 1999; serial number of R&S®SFQ must be stated	R&S®SFQ-B18	2072.7191.02
Factory-fitting of R&S®SFQ-B18 to R&S®SFQs delivered before 1999	R&S®SFQ-U11	2072.7040.02
Fading Simulator, paths 1 to 6 (for R&S®SFQ delivered before 1999 see R&S®SFQ-B18)	R&S®SFQ-B11	2072.6189.02
Fading Simulator, paths 7 to 12	R&S®SFQ-B11	2072.6189.04
Noise Generator, can be retrofitted and calibrated	R&S®SFQ-B5	2072.7579.03
Impulsive Noise	R&S®SFQ-B27	2210.0407.02
BER Measurement	R&S®SFQ-B17	2072.7056.02
Broadband FM Modulator for baseband (PAL, SECAM, NTSC) and FM sound (2 subcarriers)	R&S®SFQ-B2	2072.6108.02
2 FM Sound Subcarriers 5 MHz to 9 MHz with 2 audio generators and 2 external audio inputs	R&S®SFQ-B3	2072.7379.02
2 ADR Sound Subcarriers 0.1 MHz to 9 MHz with 2 MUSICAM generators and 1 external data input	R&S®SFQ-B4	2072.7479.02
<b>Extras</b>		
Documentation of R&S®SFQ calibration values	R&S®SFQ-DCV	2082.0490.12
Cable Set for diversity	R&S®SFQ-Z5	2081.9158.02
Common Interface TS OUT	R&S®SFQ-Z17	2081.9364.02
Service Kit	R&S®SFQ-Z1	2072.5960.02
Service Manual (English)		2072.6489.22
Memory Card 10 Mbyte (Flash)		0048.5877.00
19" Adapter (4 HU) for rackmounting	R&S®ZZA-94	0396.4905.00
Matching Pads 50 Ω/75 Ω, 0 Hz to 2.7 GHz, N connectors		
matched at both ends, attenuation 5.7 dB, no DC isolation	R&S®RAM	0358.5414.02
matched at one end, attenuation 1.7 dB	R&S®RAZ	0358.5714.02



Contents Overview

Chapter Overview

Type Index

R&S Addresses







Contents Overview

Chapter Overview

Type Index

R&S Addresses



## Brief description

With its TV Generators R&S®SGxF for all traditional colour standards, Rohde&Schwarz has the right unit for any production, studio and service requirement.

## Main features

- ◆ More than 30 baseband signals
- ◆ General-purpose test pattern with optional text insertion for source identification
- ◆ Signal output on the front and rear panel
- ◆ Remote control of all generator functions via IEC/IEEE bus
- ◆ Insertion test signals included in every signal
- ◆ Insertion of external test signals into the field blanking interval or application of sweep signals to the active picture area
- ◆ Use as test signal inserter with the genlock option fitted

## Digital picture generation

With the PAL generator, the three components  $Y$ ,  $C_B$  and  $C_R$  are stored for digital generation of the realtime composite colour video signal (CCVS).

For generation of the test signals to PAL, NTSC and SECAM, about 1000 different video lines are stored digitally and can be combined to obtain the desired pattern under program control.

## Test signals

For all three generators the assignment of a test signal to a specific line can be programmed via DIP switches. Eight complete test signal configurations can be stored and recalled enabling the user to tackle any measurement task.

## Output signal

The signal amplitude can be set via the IEC/IEEE bus or manually by a potentiometer. On all models separate amplifiers ensure decoupling between the front and the rear outputs.

## Options

For options see ordering information. Some options cannot be retrofitted. With the genlock option for test signal insertion fitted, switchover to the selected substitution pattern is ensured in the case of program failure.

The right generator for every standard: PAL, SECAM and NTSC

## Specifications

You will find detailed and binding data on the enclosed CD (../DATASHEET/SGxF.pdf), or for the latest updates, visit [www.rohde-schwarz.com](http://www.rohde-schwarz.com), search term: SGPF, SGSF, SGMF

## Ordering information

TV Generator for		
PAL	R&S®SGPF	2016.4049.03
SECAM	R&S®SGSF	2016.7048.03
NTSC	R&S®SGMF	2016.0943.03
Options		
(some options cannot be retrofitted)		
Source Identification	R&S®SG.F-B1	2016.1004.02
Test Signal Insertion	R&S®SGPF-B2	2016.4278.02
	R&S®SGSF-B2	2016.7190.02
	R&S®SGMF-B2	2016.1185.02
FuBK Test Pattern French	R&S®SGPF-B3	2016.4284.02
French Front-panel Labelling	R&S®SGSF-B3	2016.7225.02
General-purpose Test Pattern of 16:9 aspect ratio	R&S®SGPF-B4	2016.4290.02
Extras		
Junction Panel with bypass	R&S®SG.F-Z	2016.1679.02
19" Adapter	R&S®ZZA-91	0396.4870.00
Calibration Data Documentation	R&S®SG.-DCV	2082.0490.04



Contents Overview

Chapter Overview

Type Index

R&S Addresses





Contents Overview

Chapter Overview

Type Index

R&S Addresses



## Video Analyzer R&S®UAF

### Standards B/G, D/K, I, M

Perfection in video analysis:

fast, precise, reliable



### Brief description

Thanks to its characteristics, Video Analyzer R&S®UAF meets all requirements as regards high measurement accuracy for the studio and fast measurements down to a few seconds. User-friendly operation and a clear display with graphics support afford straightforward measurements.

### Main features

- ◆ 3 signal inputs
- ◆ 29 video parameters
- ◆ Limit monitoring
- ◆ Full-field measurements
- ◆ Freely selectable test signal
- ◆ Memory card, printer interface

The core of the digital section is a micro-processor plus an arithmetic coprocessor. The signal analysis comprises 29 video and test line parameters and covers all important levels as well as linear and nonlinear distortion such as 2T K rating, frequency response and hum. Optionally 50 Hz tilt, 200 ns overshoot, NICAM and dual-sound intermodulation can be measured. The position of the test lines can be freely selected over the entire picture area and in the field blanking interval; storage of up to eight test configurations is possible.

Thanks to its variable integration time, the R&S®UAF can be adapted to all test conditions. Using the shortest integration

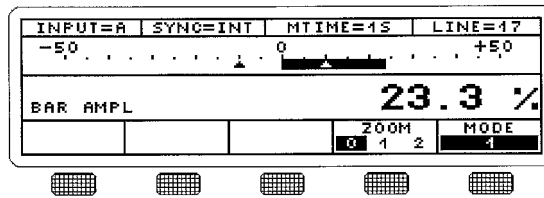

Video Analyzer R&S®UAF

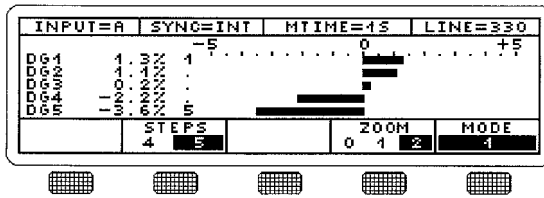

The test results are displayed either in the form of numeric values or as a bar

time of less than 1 s, the R&S®UAF is for all alignments. In the case of very noisy signals, stable results can be obtained by increasing the integration time to 2.5, 5 or 10 s.

For use in quality and production control of video recorders, the R&S®UAF also handles the S-VHS component signals Y/C. Distorted test signals do not affect the operation of the R&S®UAF.

Using a plug-in memory card, customer-defined test programs can be loaded and test results stored on the card. Moreover, the memory card permits storage of complete instrument setups.

### Operation

The logical arrangement of the R&S®UAF front-panel controls offers a clear overview of its functions and ensures ease of operation. Each parameter is assigned its

own key. The associated LED above the key blinks if the limit values are exceeded.

The keypad to the left of the display permits the setup menus of the R&S®UAF to be selected directly. Such a menu is inserted as a window above the normal result display. Thus it is possible to use the softkeys for changing general settings such as the input, synchronization, printer mode, etc.

The "option" function allows further test parameters, e.g. an external level or future extensions, to be called up.

Special modes are the difference and the reference measurement modes with which signal errors at the input of the device under test can be eliminated. The AUTORUN menu permits test sequences to be programmed on the R&S®UAF front panel; these sequences are executed automatically and can be repeated cyclically.



Contents Overview

Chapter Overview

Type Index

R&S Addresses





Contents Overview

Chapter Overview

Type Index

R&amp;S Addresses



## Video Analyzer R&amp;S®UAF

## Specifications

You will find detailed and binding data on the enclosed CD (../DATASHEET/UAF.pdf), or, for the latest updates, visit [www.rohde-schwarz.com](http://www.rohde-schwarz.com), search term: UAF

## Ordering information

Video Analyzer		
Standard B/G	R&S® UAF	2013.0807.02
Standard D/K	R&S® UAF	2028.5780.02
Standard M	R&S® UAF	2028.5774.02
Standard I	R&S® UAF	2028.5768.05
Other standards	on request	
<b>Accessories supplied</b>	four 75 $\Omega$ Terminations RMF2, 32 kbyte memory card	
Options		
50 Hz tilt, 200 ns overshoot	R&S® UAF-B1	2028.6406.02
S/N extension		
552 kHz (NICAM)	R&S® UAF-B2	2028.6412.02
242 kHz (dual sound)	R&S® UAF-B3	2028.6429.02
Calibration Data Documentation	R&S® UAF-DCV	2082.0490.05
Extras		
Memory card		
32 Kbyte	R&S® ZM-32	2005.4394.02
512 Kbyte	R&S® ZM-512	2013.1684.24
Service Manual		



Contents Overview

Chapter Overview

Type Index

R&amp;S Addresses





Contents Overview

Chapter Overview

Type Index

R&amp;S Addresses



## Digital Video Component Analyzer R&S®VCA, DTL Analysis R&S®VCA-B11

### R&S®VCA: combined waveform monitor and analyzer

### With R&S®VCA-B11: additional jitter analysis and spectral measurements

*Digital Video Component Analyzer R&S®VCA*

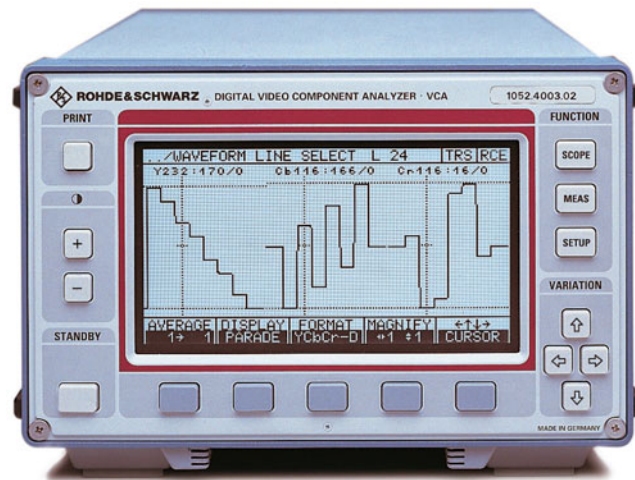

### Brief description

Digital Video Component Analyzer R&S®VCA is designed to solve measurement problems in the digital studio, in operation and servicing as well as in the development of digital studio equipment. Combining the characteristics of a waveform monitor and an analyzer and including all conventional display modes, the R&S®VCA is suitable for a great variety of measurements and so makes working with digital video signals easy. An optional remote control unit permits the R&S®VCA to be readily integrated into large measuring systems for comprehensive monitoring in the studio.

### Main features

- ◆ To standards ITU-R BT. 601/656, SMPTE125M/259M, 8 bits, 10 bits, 625/525 lines
- ◆ Waveform display
- ◆ Numeric output of video data
- ◆ Analysis of data frame/contents
- ◆ Timing and level measurements
- ◆ Hardcopy of screen via external printer
- ◆ DTL analysis (optional)
- ◆ Remote control (optional)

Equipped with a digital-parallel and a digital-serial video input as well as SCOPE and MEASURE functions,

R&S®VCA is capable of monitoring the digital video signal at all the transfer points of a digital TV studio. Measurement results are clearly displayed on a large-size monitor. Compared to the purely visual information obtained from an oscilloscope, R&S®VCA reads out precise measurement values. A graphic display facilitates evaluation of the results.

#### SCOPE functions

These functions allow waveforms and numerical values of the digital video signal to be analyzed.

#### MEASURE functions

These functions are used for monitoring and measuring live signals and for measuring special test signals. In the SCOPE mode, too, two monitoring functions are active in the background for checking the sync frame. The results of measurements on live signals are shown on the ERROR RATE display or on a new type of HISTORY display.

#### DTL analysis option (R&S®VCA-B11)

The DTL analysis option (digital transport layer) allows to search for the physical causes of data errors in serial-digital video

signals, with signal jitter playing an important role in this respect. R&S®VCA performs jitter measurements according to the demodulator method and also supports measurements to the clock extractor method.

### Specifications

**You will find detailed and binding data on the enclosed CD (./DATASHEET/VCA.pdf), or, for the latest updates, visit [www.rohde-schwarz.com](http://www.rohde-schwarz.com), search term: VCA, VCA-B11**

### Ordering information

Digital Video Component Analyzer	R&S®VCA	1052.4003.02
<b>Options</b>		
Remote Control (RS-232-C/RS-422)	R&S®VCA-B1	1052.5600.02
DTL Analysis	R&S®VCA-B11	1052.5800.02
SWR Bridge 5 MHz to 850 MHz	R&S®VCA-Z1	1052.5900.02
Calibration Data Documentation	R&S®VCA-DCV	2082.0490.06
Same for R&S®VCA-B11	R&S®VCA-DCV	2082.0490.07



Contents Overview

Chapter Overview

Type Index

R&amp;S Addresses





Contents Overview

Chapter Overview

Type Index

R&amp;S Addresses



## Video Measurement System R&amp;S®VSA

## DC to 9 MHz

**Compact platform for video signal analysis: measurements of all relevant video parameters in the baseband, graphic and numeric result display, vector and waveform display**

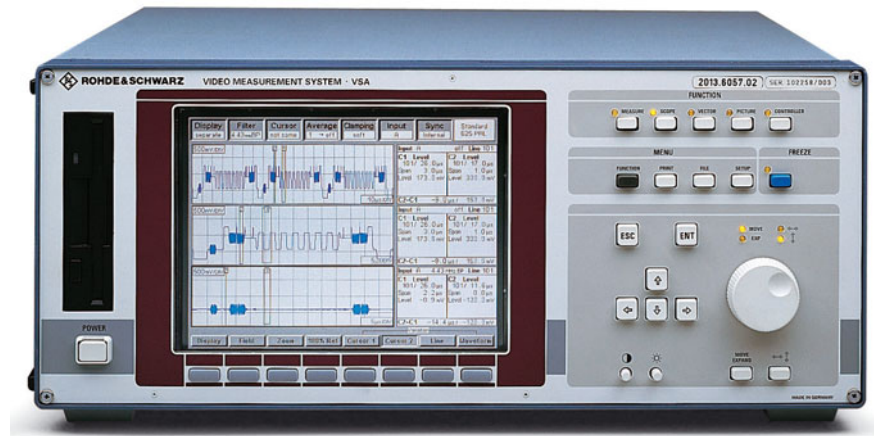

Video Measurement System R&amp;S®VSA

## Brief description

Video Measurement System R&S®VSA combines the functions of a video analyzer, vectorscope, oscilloscope, monitor and controller (PC) in a 19" desktop.

## Fields of applications are

- ◆ laboratory and service
- ◆ automatic test and monitoring systems
- ◆ production and quality assurance

The instrument features convenient operation as well as high measurement accuracy and speed. The compact design makes it also suitable for mobile applications. Thanks to the great number of integrated functions and system interfaces the R&S®VSA is an essential tool for measurements and system applications in all fields of video.

In addition to the versatile measurement capabilities provided, the modular software and hardware configuration offers sufficient capacity for future expansions.

## Main features

- ◆ Four loopthrough video signal inputs with analog 9 MHz bandwidth
- ◆ DOS- and Windows-compatible PC with IEC/IEEE-bus controller
- ◆ Multitasking operating system
- ◆ Connectors for external keyboard and colour monitor
- ◆ Colour graphic LCD display
- ◆ Two serial interfaces
- ◆ SCPI remote control via IEC/IEEE or serial interface
- ◆ Printer interface
- ◆ 3.5" floppy disk drive (DOS format) for result transfer and software options
- ◆ Hard disk
- ◆ Modular design with hardware and software options

## Five instruments in one

- ◆ **Video and FFT analyzer**
- ◆ Simultaneous computation of up to **150 different signal parameters**
- ◆ Automatic limit monitoring
- ◆ Automatic overall measurement of all parameters

- ◆ Individual measurements using extended test capabilities
- ◆ Test-signal and test-location display
- ◆ Standard or reference measurement for each parameter separately
- ◆ **3-channel oscilloscope**
- ◆ Simultaneous display of up to three video signals in separate displays
- ◆ Separate test input for each part display (e.g. components, RGB, YC<sub>B</sub>C<sub>R</sub>)
- ◆ Simultaneous display of the same signal with different time scales in up to three separate windows
- ◆ Displayed signal section variable in the x and y direction from 200 ns to 20 ms
- ◆ Digital filters for simulating signal manipulations, e.g. all CCIR filters for insertion signal measurements
- ◆ Scale automatically matched to the display
- ◆ Two cursors for each window: LEVEL, PEAK, SLOPE and PULSE functions allow analysis of complete signal elements



Contents Overview

Chapter Overview

Type Index

R&amp;S Addresses



## Video Measurement System R&S®VSA

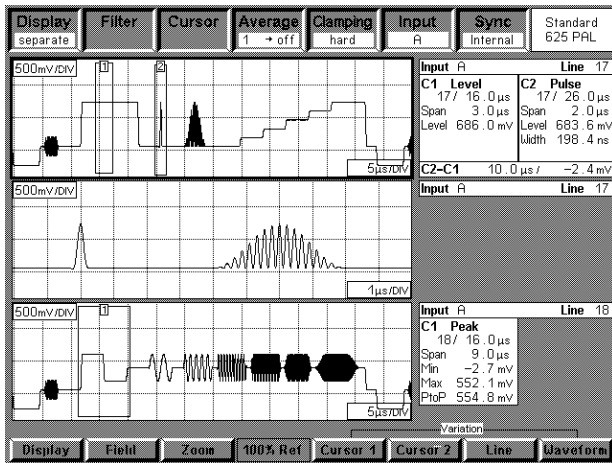

Fig. 1: With a single sin x/x measurement the result display is divided, one part showing the amplitude frequency response and the other the group delay. An info and a cursor window are assigned to each spectrum

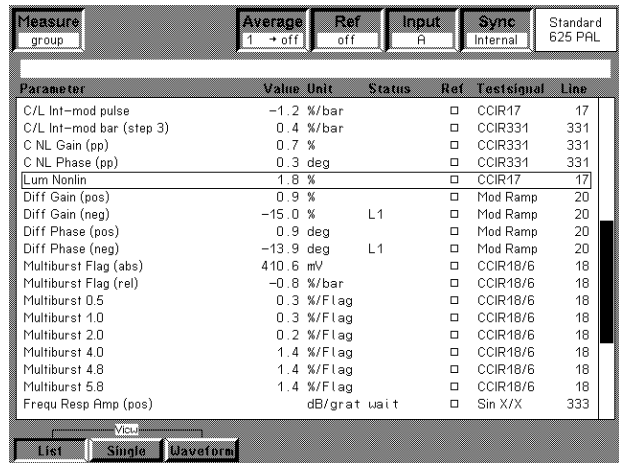

Fig. 2: In the list mode, selected video parameters and their measured values are displayed in the form of a list

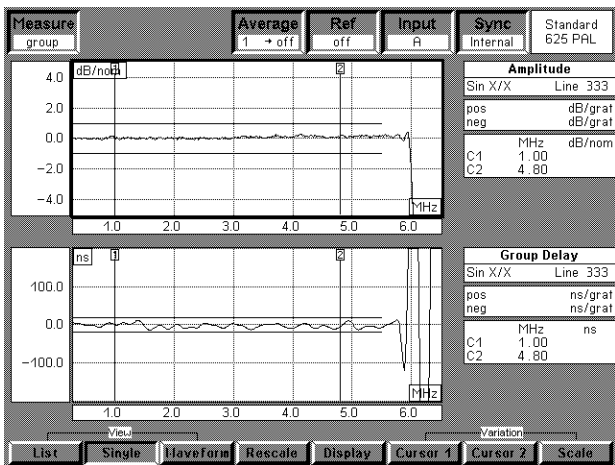

Fig. 3: In the SCOPE mode the screen is divided in a signal, an info and a cursor window. The waveform of one video signal can be displayed simultaneously in up to three windows with continuously variable time and amplitude scaling

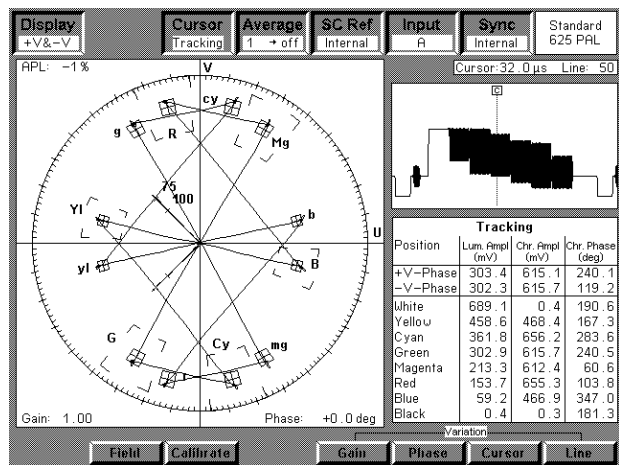
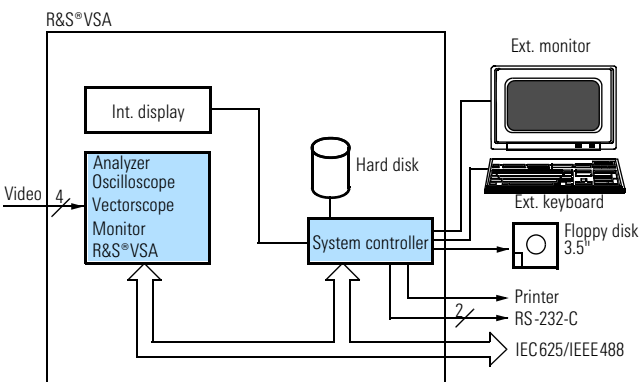

Fig. 4: In the vectorscope function the magnitude and phase of all colour parameters of a video line are shown in a graphics display; the line is also displayed in the waveform window. A cursor line in the waveform display of the video line marks the measurement time for colour subcarrier amplitude and phase. The cursor corresponds to one or two markers in the vector diagram. When the cursor line is shifted, the markers track the vector curve





Contents Overview

Chapter Overview

Type Index

R&S Addresses



## Video Measurement System R&S®VSA

### Vectorscope

- ◆ Graphic display of all colour parameters of a video line in magnitude and phase
- ◆ Accurate measurement of phase difference of two colour signal subcarriers by alternate suppression of colour subcarrier reference
- ◆ Permanent waveform display of video line
- ◆ Automatic computation and display of all colour subcarrier amplitudes and phases when a standard colour bar signal is applied

### Monitor

- ◆ Easy identification of selected video signal
- ◆ Display of a video signal as monochrome TV picture with eight grey levels
- ◆ Simultaneous display of any rollkey-selected video line of the TV picture

### System controller

- ◆ Comprehensive automatic test system
- ◆ Control of external devices via IEC/IEEE bus or serial interface
- ◆ Complete PC (DOS + Windows) with integrated IEC/IEEE-bus card
- ◆ Computing and measurement functions independent of each other
- ◆ Simple switch-over between measurement display and DOS display
- ◆ VGA colour monitor and external keyboard available as accessories

### Specifications

You will find detailed and binding data on the enclosed CD (../DATASHEET/VSA.pdf), or, for the latest updates, visit [www.rohde-schwarz.com](http://www.rohde-schwarz.com), search term: VSA

### Ordering information

<b>Video Measurement System</b>	R&S®VSA	2013.6057.04
<b>Option</b>		
Calibration Data Documentation	R&S®VSA-DCV	2082.0490.08



Contents Overview

Chapter Overview

Type Index

R&S Addresses





## TV Test Receiver Option R&S®VSA-B10

47 MHz to 862 MHz

RF parameter measurement and monitoring with Video Measurement System R&S®VSA

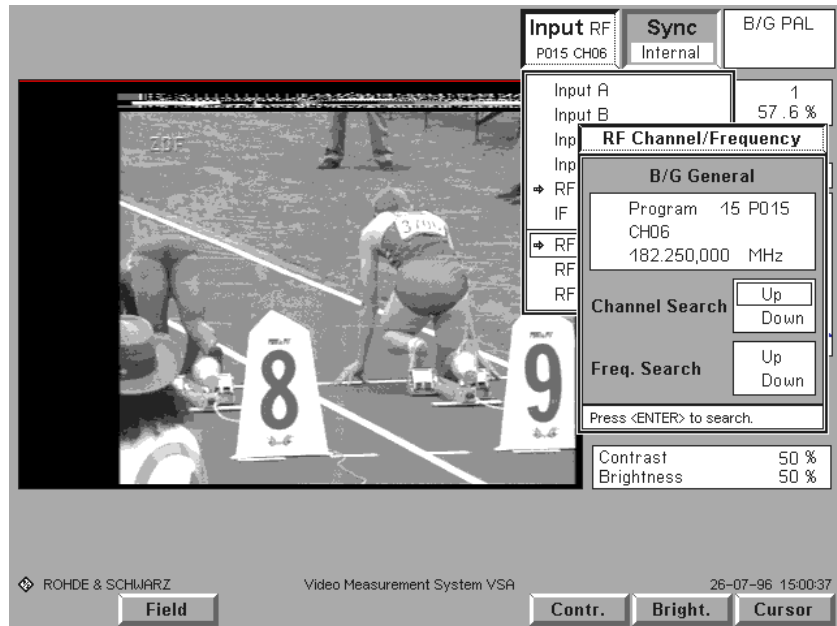

*R&S®VSA screen with channel setting of Test Receiver, option R&S®VSA-B10*

### Brief description

TV Test Receiver Option R&S®VSA-B10 enhances the Video Measurement System R&S®VSA (page 165) for the reception and analysis of RF and IF TV signals. The system allows all important RF and VF quality parameters to be analyzed in a single unit. R&S®VSA-B10 can easily be retrofitted – even on site – without calibration and level adjustment and with no problems regarding interfaces or cabling.

**R&S®VSA with Option R&S®VSA-B10 provides the following functions:**

- ◆ TV test receiver for standards B/G, I, D/K, K1
- ◆ Video and FFT analyzer
- ◆ 3-channel oscilloscope
- ◆ Vectorscope
- ◆ Monitor
- ◆ System controller

### Features of R&S®VSA with Option R&S®VSA-B10

- ◆ RF/video analysis in a single unit
- ◆ Measurement of all relevant RF and VF quality parameters
- ◆ High-speed analysis
- ◆ No external cabling
- ◆ Easy to transport
- ◆ Little space required
- ◆ Uniform user interface for all measurement functions
- ◆ RF test parameters displayed in parameter list of R&S®VSA
- ◆ Display of test receiver configuration on R&S®VSA screen

**R&S®VSA-B10 allows measurement of the following additional parameters:**

- ◆ Incidental carrier phase modulation (ICPM) of vision carrier
- ◆ Vision and sound carrier level and frequency

- ◆ Modulation depth of vision carrier (residual carrier) and sound carrier (FM deviation)
- ◆ Pilot deviation and frequency
- ◆ Pilot decoding

### Features of TV test receiver

- ◆ Models with 50  $\Omega$  or 75  $\Omega$  input
- ◆ IF input and IF output
- ◆ Video and audio outputs
- ◆ Dynamic range 40 dB $\mu$ V to 120 dB $\mu$ V
- ◆ Low-noise and low-distortion mode
- ◆ Low-noise preamplifier can be switched on to improve noise figure of receiver
- ◆ Video S/N ratio (weighted at 66 dB $\mu$ V) >56 dB
- ◆ Inter-carrier S/N ratio (weighted) >46 dB
- ◆ Program, channel and frequency entry
- ◆ Channel and frequency search
- ◆ Synthesizer with low phase noise and high frequency resolution (1 Hz)







Contents Overview

Chapter Overview

Type Index

R&S Addresses



## TV Test Receiver Option R&S®VSA-B10

- ◆ Digital frequency control
- ◆ Manual and automatic gain control
- ◆ Integrated zero clamping for defining vision modulation depth
- ◆ Selectable synchronous detector mode with sampled or continuous phase control as well as selectable time constants
- ◆ Sound demodulation and decoding according to IRT dual-sound carrier method
- ◆ Linear distortion of video frequency response <0.5 dB (luminance/chrominance error <±20 ns)
- ◆ Video group-delay correction of receiver and sound deemphasis can be switched off
- ◆ Sound monitoring via loudspeaker of basic unit
- ◆ Very easy installation in R&S®VSA

### Specifications

You will find detailed and binding data on the enclosed CD (./DATASHEET/VSA-B10.pdf), or, for the latest updates, visit [www.rohde-schwarz.com](http://www.rohde-schwarz.com), search term: VSA-B10

### Ordering information

TV Test Receiver Option		
Standard B/G Europe, dual sound, 50 Ω	R&S®VSA-B10	2014.0000.02
IF 38.9 MHz + 33.4/33.158 MHz, 75 Ω	R&S®VSA-B10	2014.0000.03
Standard B/G Europe, mono sound, 50 Ω	R&S®VSA-B10	2014.0000.06
IF 38.9 MHz + 33.4 MHz, 75 Ω	R&S®VSA-B10	2014.0000.07
Standard B/G Australia, dual sound, 50 Ω	R&S®VSA-B10	2014.0000.10
IF 38.9 MHz + 33.4/33.158 MHz, 75 Ω	R&S®VSA-B10	2014.0000.11
Standard D/K CCIR, dual sound, 50 Ω	R&S®VSA-B10	2014.0000.40
IF 38.9 MHz + 32.4/32.642 MHz, 75 Ω	R&S®VSA-B10	2014.0000.41
Standard D/K CCIR, dual sound, 50 Ω	R&S®VSA-B10	2014.0000.42
IF 38.9 MHz + 32.4/32.158 MHz, 75 Ω	R&S®VSA-B10	2014.0000.43
Standard D/K NICAM, 50 Ω		
IF 32.4 MHz	R&S®VSA-B10	2014.0000.44
Standard I UK, mono sound, 50 Ω	R&S®VSA-B10	2014.0000.70
IF 38.9 MHz + 32.9 MHz, 75 Ω	R&S®VSA-B10	2014.0000.71
Standard I SABC, mono sound, 50 Ω	R&S®VSA-B10	2014.0000.72
IF 38.9 MHz + 32.9 MHz, 75 Ω	R&S®VSA-B10	2014.0000.73
Other standards on request.		
Calibration Data Documentation	R&S®VSA-DCV	2082.0490.10



Contents Overview

Chapter Overview

Type Index

R&S Addresses





Contents Overview

Chapter Overview

Type Index

R&S Addresses



## Contents of Chapter 4

Designation	Type	Frequency range	Description	Page
Handheld Spectrum Analyzer	R&S® FSH3	100 kHz to 3 GHz	Robust, portable spectrum analyzer that can be used in the field	172
Spectrum Analyzer	R&S® FS300	9 kHz to 3 GHz	Professional test equipment for laboratory, service and production	174
Spectrum Analyzers	R&S® FSP3/7/13/30/40	9 kHz to 3/7/13.6/30/40 GHz	The new standard in the medium class: Unparalleled range of functions, high measurement speed, maximum in precision	176
Spectrum Analyzers	R&S® FSU3/7/26/46/50	20 Hz to 3.6/8/26.5/46/50 GHz	High-end spectrum analyzer with unmatched performance	180
Signal Analyzers	R&S® FSQ3/8/26	20 Hz to 3.6/8/26 GHz	Signal analysis with the dynamic range of a high-end spectrum analyzer and a demodulation bandwidth up to 120 MHz	184
Harmonic Mixers	R&S® FS-Z60/75 R&S® FS-Z90/110	40/50 to 60/75 GHz 60/75 to 90/110 GHz	Frequency range extension to 110 GHz for Spectrum Analyzers R&S® FSEM und R&S® FSEK, Signal Analyzers R&S® FSQ26 and EMI Test Receivers R&S® ESIB26 and R&S® ESIB40	211
Vector Network Analyzers	R&S® ZVB4 R&S® ZVB8	300 kHz to 4 GHz 300 kHz to 8 GHz	The network analyzers of the R&S® ZVB family feature an innovative reflectometer concept that sets new standards	213
Vector Network Analyzers	R&S® ZVM/ZVK	10 MHz to 20/40 GHz	High-precision and versatile vector network analyzers	217
SWR Bridges	R&S® ZR/A/B2/C R&S® VCA-Z1	40 kHz to 4 GHz 5 MHz to 850 MHz	Measurement of reflection coefficient (RF circuits/components)	222



Contents Overview

Chapter Overview

Type Index

R&S Addresses





Contents Overview

Chapter Overview

Type Index

R&amp;S Addresses



## Application Specific Options for the Spectrum and Signal Analyzer Families R&S® FSP/FSU/FSQ

Designation	Type	R&S®	FSP	FSU	FSQ	Remarks	Page
<b>General Measurement Applications</b>							
Noise Figure Measurement Software	R&S®FS-K3		•	•	•	Noise measurements, preamplifier recommended (Windows software)	188
Application Firmware for Noise Figure and Gain Measurements	R&S®FS-K30		•	•	•	For R&S®FSP/FSU/FSQ with Windows XP: Outperforming any conventional noise measurement system, preamplifier recommended	189
Phase Noise Measurement Software	R&S®FS-K4		•	•	•	Phase noise measurements (Windows software)	190
AM/FM/PM Measurement Demodulator	R&S®FS-K7		•	•	•	FM Measurement Demodulator for Spectrum Analyzer R&S®FSP for determining analog modulation parameters	191
<b>Mobile radio specific applications</b>							
Option Vector Signal Analyzer	R&S®FSQ-K70				•	Universal demodulation, analysis, documentation of digital radio signals	193
GSM/EDGE Application Firmware	R&S®FS-K5		•	•	•	The solution for easy and fast GSM and EDGE measurements	195
WCDMA 3GPP Application Firmware	R&S®FS-K72		•	•	•	Modulation and code domain power measurements on base station signals (Node B) according to 3GPP TS24.141. Required options for R&S®FSP: R&S®FSP-B15 and R&S®FSP-B70	197
3GPP HSDPA BTS Application Firmware	R&S®FS-K74		•	•	•	Extends the R&S®FS-K72 to include HSDPA	
WCDMA 3GPP Application Firmware	R&S®FS-K73		•	•	•	Modulation and code domain power measurements on modulation signals (UE) according to 3GPP TS25.121. Required options for R&S®FSP: R&S®FSP-B15 for slot-based measurements and R&S®FSP-B70 for frame-based measurements	197
TD-SCDMA Test Application Firmware	R&S®FS-K76		•	•	•	Adds measurement functions in line with 3GPP as well as China Wireless Telecommunication Standard Group (CWTS) and provides the functionality needed for base-station testing	199
TD-SCDMA Test Application Firmware	R&S®FS-K77		•	•	•	Adds measurement functions in line with 3GPP as well as China Wireless Telecommunication Standard Group (CWTS) and provides user equipment functionality	199
cdma2000 Base Station Test Application Firmware	R&S®FS-K82		•	•	•	Modulation and code domain power measurements on cdma2000 base station signals (also applicable for IS-95/cdmaOne signals)	201
1xEV-DO Base Station Test Application Firmware	R&S®FS-K84		•	•	•	Modulation and code domain power measurements on 1xEV-DO base station signals	201
cdma2000/1xEV-DV Mobile Station Test Application Firmware	R&S®FS-K83		•	•	•	Transmitter measurements on cdma2000 and 1xEV-DV reverse link	203
cdma2000 1xEV-DO MS Application Firmware	R&S®FS-K85		•	•	•	Modulation and code domain power measurements on 1xEV-DO mobile station signals	
<b>Other wireless applications</b>							
Bluetooth Application Firmware	R&S®FS-K8		•	•	•	Bluetooth transmitter measurements	205
WLAN 802.11a Application Firmware	R&S®FSP-K90		•			OFDM analysis on WLAN 802.11a and WLAN 802.11g signals	207
WLAN 802.11a Application Firmware	R&S®FSQ-K90				•	Transmitter measurements on WLAN 802.11a OFDM signals	208
WLAN 802.11a/b/g/j Application Firmware	R&S®FSQ-K91				•	OFDM analysis and DSSS/CCK analysis	208
<b>TV measurement applications</b>							
TV Trigger/RF Power Trigger	R&S®FSP-B6		•			Makes the Spectrum Analyzers R&S®FSP suitable for analog TV measurement applications	210



Contents Overview

Chapter Overview

Type Index

R&amp;S Addresses





Contents Overview

Chapter Overview

Type Index

R&amp;S Addresses



## Handheld Spectrum Analyzer R&S®FSH3

100 kHz to 3 GHz

**Robust, portable spectrum analyzer  
that can be used in the field**

### Brief description

The R&S®FSH3 is the ideal spectrum analyzer for rapid, high-precision, cost-effective signal investigations. It provides a large number of measurement functions and so can handle anything from the installation or maintenance of a mobile radio base station up to on-site fault location in RF cables to development and service – an extensive range of applications.

### Main features

- ◆ High measurement accuracy
- ◆ Best RF characteristics in this class
- ◆ Colour display, 320 × 240 pixels
- ◆ High measurement comfort
  - Marker
  - Delta marker
  - Noise marker
  - Frequency counter
- ◆ Simple menu-based operation via softkeys
- ◆ Four hours operating time on battery power
- ◆ Storage of up to 100 traces and setups
- ◆ Connection to PC via interference-free, RS-232-C optical interface
- ◆ Robust edge protection, stable carrying handle

### R&S®FSH View Software

- ◆ Runs under Windows 98/ME/NT/2000/XP
- ◆ Graphics data stored in standard formats (.bmp, .pcx, .png, .wmf)
- ◆ Data export in ASCII or Excel format



### Options and applications

The R&S®FSH3 is available with and without an internal tracking generator, thus enhancing its scope of applications by distance-to-fault (DTF) measurements and scalar network analysis. Another model with an adjustable preamplifier is particularly suited for measuring very small signals and includes as standard a tracking generator with selectable output level (0 dBm/–20 dBm). Two power sensors are available as accessories for high-precision power measurements up to 8 GHz and 18 GHz. The table below indicates which configuration is required for each application.

Product/application	TDMA power measurement	Channel-power measurement	Field strength measurement	Power measurement up to 8/18 GHz	Measurement on cables (distance-to-fault)	Scalar transmission measurement Vector transmission measurement <sup>1)</sup>	Scalar reflection measurement Vector reflection measurement <sup>1)</sup>
R&S®FSH3	•	•					
R&S®FSH3 incl. tracking generator	•	•				•	
R&S®FSH3 incl. tracking generator + SWR Bridge R&S®FSH-Z2 + DTF Function R&S®FSH-B1	•	•			•	•	•
R&S®FSH3 + Power Sensor R&S®FSH-Z1/-Z18	•	•		•			
R&S®FSH3 incl. tracking generator + Power Sensor R&S®FSH-Z1/-Z18 + SWR Bridge R&S®FSH-Z2 + DTF Function R&S®FSH-B1	•	•		•	•	•	•

1) R&S®FSH-Z2 required



Contents Overview

Chapter Overview

Type Index

R&amp;S Addresses



## Handheld Spectrum Analyzer R&S®FSH 3

- ◆ Printout of all relevant data via Windows (screenshot of the R&S®FSH3 display for documentation)
- ◆ Permanent and continuous transfer of sweeps to the PC; facilities for subsequent analysis (markers, zoom, etc)
- ◆ Editor for the generation of limit lines, transducer factors and correction factors for external attenuators/amplifiers
- ◆ Macro function for Word for fast and easy documentation of measurement results

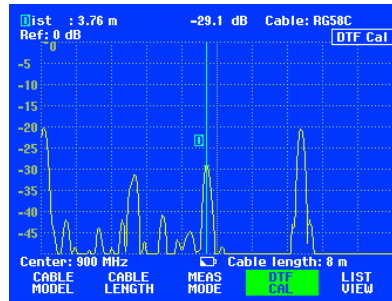

*Distance-to fault measurement for rapidly and accurately determining the distance to any defects in an RF cable*

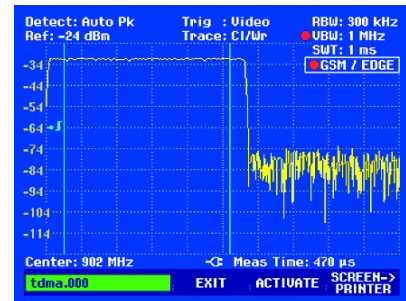

*TDMA POWER function performs time-domain power measurements in these timeslots; all the settings required for the GSM and EDGE standards are predefined*

### Specifications in brief

You will find detailed and binding data on the enclosed CD (./DATASHEET/FSH3.pdf), or, for the latest updates, visit [www.rohde-schwarz.com](http://www.rohde-schwarz.com), search term: FSH3

Frequency	
Frequency range	100 kHz to 3 GHz
Frequency counter, resolution	1 Hz
Span	10 kHz to 3 GHz, 0 Hz
Spectral purity (SSB phase noise, f = 500 MHz, 20°C to 30°C) 1 MHz carrier offset	<120 dBc/(1 Hz)
Sweep time, span ≥10 kHz	100 ms to 1000 s
Sweep time, span = 0 Hz	1 ms to 100 s
Resolution bandwidths (-3 dB)	1 kHz to 1 MHz in 1, 3 steps
Video bandwidths	10 Hz to 1 MHz in 1, 3 steps
Amplitude	
Intermodulation-free range	70 dB (+15 dBm IP3)
Displayed average noise floor	typ. -116 dBm
Spurious response (ref. lev. ≤-10 dBm, f >30 MHz, RBW ≤100 kHz)	<-80 dBm
Image frequ. (carrier offset >1 MHz)	<-70 dBc (nominal)
Level display	
Reference level	-80 to +20 dBm in 1-dB steps
Level display error (ref. level -50 dB)	1.5 dB (+20°C to +30°C)
Trace detector	Auto Peak, Max Peak, Sample, RMS
Markers	
	1 marker and 1 delta marker
Power sensor R&S®FSH-Z1	
Frequency range	10 MHz to 8 GHz
Measurement range	200 pW to 200 mW
General data	
Display	14 cm (5.7") colour LCD, 320×240 pixels
Serial interface	Optical RS-232-C interface
Power supply	
Ext. power supply (R&S®FSH-Z33)	100 V to 240 V AC, 50 to 60 Hz, 400 mA
External DC voltage	15 V to 20 V
Internal battery (NiMH battery)	6 V to 9 V
Operating temperature range	0°C to +50°C (battery operation)
Dimensions (W × H × D)	170 mm × 120 mm × 270 mm
Weight	2.5 kg

### Ordering information

Handheld Spectrum Analyzer		
100 kHz to 3 GHz	R&S®FSH 3	1145.5850.03
100 kHz to 3 GHz, with tracking generator	R&S®FSH 3	1145.5850.13
100 kHz to 3 GHz, with tracking generator and preamplifier	R&S®FSH 3	1145.5850.23
Accessories supplied		
External power supply, battery pack (integral), RS-232-C optical cable, headphones, CD-ROM with control software R&S®FSH View and documentation, quick start manual		
Option		
Distance-to-Fault Measurement, incl. 1 m cable and calibration termination, R&S®FSH-Z2 required	R&S®FSH-B1	1145.5750.02
Remote Control via RS-232-C	R&S®FSH-K1	1157.3458.02
Vector Transmission and Reflection Measurements	R&S®FSH-K2	1157.3387.02
Extras		
Power sensor, 10 MHz to 8 GHz, incl. calibration standards (open, short, 50 Ω load)	R&S®FSH-Z1	1155.4505.02
Power Sensor, 10 MHz to 18 GHz	R&S®FSH-Z18	1165.1909.02
SWR Bridge and Power Divider 10 MHz to 3 GHz	R&S®FSH-Z2	1145.5767.02
Matching Pad 50/75 Ω, 0 to 2.7 GHz	R&S®RAZ	0358.5714.02
12-V Car Adapter	R&S®FSH-Z21	1145.5873.02
Serial/Parallel Converter	R&S®FSH-Z22	1145.5880.02
Additional RF cable, 1 m, N connectors, for R&S®FSH-B1	R&S®FSH-Z20	1145.5867.02
Carrying Bag	R&S®FSH-Z25	1145.5896.02
Spare Short/Open Circuit for calibrating, for R&S®FSH-Z2	R&S®FSH-Z30	1145.5773.02
Spare 50-Ω Load Standard, for R&S®FSH-Z2	R&S®FSH-Z31	1145.5780.02
Spare Battery Pack	R&S®FSH-Z32	1145.5796.02
Spare AC Power Supply	R&S®FSH-Z33	1145.5809.02
RS-232-C Optical Cable	R&S®FSH-Z34	1145.5815.02
Spare CD-ROM with Control Software		
R&S®FSH View and Documentation	R&S®FSH-Z35	1145.5821.02
Headphones	R&S®FSH-Z36	1145.5838.02



Contents Overview

Chapter Overview

Type Index

R&amp;S Addresses



## Spectrum Analyzer R&S®FS300

9 kHz to 3 GHz

Professional test equipment for laboratory, service and production



### Brief description

The R&S®FS300 is a highly accurate spectrum analyzer with a frequency range of 9 kHz to 3 GHz. Owing to its modern, digital frequency processing technique, it offers high measurement quality at a favourable price.

### Applications

- ◆ Measurement of RF spectrum (level and frequency)
- ◆ Measurement of radiated interference (EMC)
- ◆ Applications in mobile radio and wireless communication (GSM, WCDMA, DECT, W-LAN, *Bluetooth*®, etc)
- ◆ TDMA power measurements
- ◆ Radiomonitoring remote-controlled via USB

The wide frequency range from 9 kHz to 3 GHz, RF characteristics as known from a top-end instrument as well as resolution bandwidths from 200 Hz to 1 MHz make this spectrum analyzer suitable for a wide range of applications in training, electronic labs or service centers.

In addition to overview measurements with a selectable span of 1 kHz to 3 GHz, the R&S®FS300 is particularly suitable for fast measurement of electromagnetic spurious emissions and for applications in wireless communication such as radio and wireless LAN.

The instrument is of extremely compact design, with a width that occupies only one half of a 19-inch rack and measuring three units in height.

Operation is menu-guided so that even untrained users will quickly obtain correct results. Clear structures simplify navigation within the menus. The bright TFT colour display with 320 × 240 pixel resolution allows traces to be read even at odd angles or when the incidence of light is unfavourable.

Whether on the lab bench, in service or as a flexible measuring instrument in automatic production systems, the range of applications is almost unlimited.

### Main features

- ◆ High-quality measurement characteristics
- ◆ Resolution bandwidths from 200 Hz to 1 MHz
- ◆ Frequency counter with 1 Hz resolution
- ◆ Maximum input level 33 dBm
- ◆ Ergonomic user interface
- ◆ Remote control via USB interface
- ◆ High picture refresh rate
- ◆ Compact housing with flexible handle

### PC software

A powerful software option is available for remote control of the R&S®FS300 from a PC. The software enhances the R&S®FS300 functions and supports the generation of test reports on the PC.

### Characteristics

- ◆ Windows 2000/XP-compatible
- ◆ PC linked to R&S®FS300 via convenient USB interface
- ◆ Fast and simple transfer of measurements between R&S®FS300 and PC



Contents Overview

Chapter Overview

Type Index

R&amp;S Addresses





## Spectrum Analyzer R&amp;S®FS300

- ◆ Permanent sweep and transmission of ongoing sweeps to the PC with evaluation capabilities (marker, zoom, etc)
- ◆ Practically unlimited memory capacity for storing traces and measurement information (comparison of current and previous measurements)
- ◆ Extended range of functions (limit lines, log file)
- ◆ Export of trace values (900 points) in txt format for import into MS Excel
- ◆ Export of displayed data (screenshots) in JPEG format
- ◆ Output of results to standard USB printer

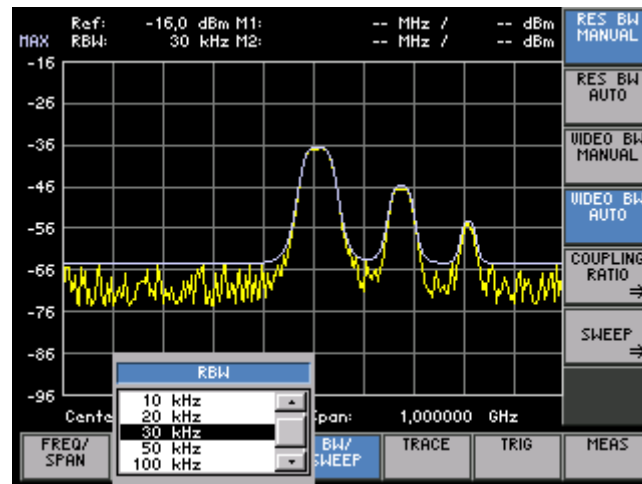

*The points in the traces are displayed with an accuracy unrivalled in this price class; this is an essential prerequisite for any measurement task*

## Specifications in brief

You will find detailed and binding data on the enclosed CD ([../DATASHEET/FS300.pdf](#)), or, for the latest updates, visit [www.rohde-schwarz.com](http://www.rohde-schwarz.com), search term: **FS300**

<b>Frequency</b>	
Frequency range	9 kHz to 3 GHz
Frequency span	1 kHz to 3 GHz, 0 Hz
<b>Spectral purity (9 kHz ≤ f ≤ 3 GHz)</b>	
SSB phase noise	
10 kHz carrier offset	<−90 dBc (1 Hz)
<b>Sweep time</b>	
Span ≥ 1 kHz	100 ms to 1000 s
Span = 0 Hz	10 μs to 20 s
<b>Bandwidths</b>	
Resolution bandwidths (3 dB)	200 Hz to 1 MHz in 1, 2, 3, 5 sequences
Video band widths	10 Hz to 1 MHz in 1, 2, 3, 5 sequences
<b>Amplitude</b>	
<b>Intermodulation-free range</b>	
Two-tone signal with 2 × −30 dBm, 0 dB input attenuation	
100 MHz to 3 GHz	≤−70 dBc
<b>Harmonics</b>	
−40 dBm, 0 dB input attenuation	≤−60 dBc
<b>Inherent spurious responses</b>	
Terminated input, 0 dB input attenuation	≤−85 dBm
<b>Other spurious</b>	
10 MHz to 3 GHz, −30 dBm level at first mixer	≤−60 dBc

Displayed average noise level f > 9 kHz, 300 Hz resolution bandwidth	
10 Hz video bandwidth, 0 dB input attenuation	−110 dBm, typ. −120 dBm
Setting range of reference level	−110 dBm to +36 dBm
Level measurement uncertainty	≤1.5 dB
<b>Marker</b>	1 marker and 1 delta marker
<b>Trigger</b>	free run, video, external, line
<b>Interfaces</b>	
USB host	A plug, protocol 1.1
USB device	B plug, protocol 1.1
Command set	device-specific, remote control via supplied Windows driver (Windows XP, 2000)
<b>General data</b>	
Display	5.4" active TFT colour display
Resolution	320 × 240 pixels
<b>Power supply</b>	
Input voltage range	100 V to 240 V (AC), 50 to 60 Hz, automatic range setting
Power consumption	< 35 VA
Permissible temperature range	+5° C to +45° C
Dimensions (W × H × D)	219 mm × 147 mm × 350 mm
Weight	7.4 kg

## Ordering information

<b>Spectrum Analyzer</b>	R&S®FS300	1147.0991.03
PC Software	R&S®FS300-K1	1147.1017.02
Rack Adapter	R&S®ZZA-300	1147.1281.00





Contents Overview

Chapter Overview

Type Index

R&amp;S Addresses



## Spectrum Analyzers R&amp;S®FSP

9 kHz to 40 GHz

The new medium-class standard:

Unparalleled range of functions

High measurement speed

Maximum in precision

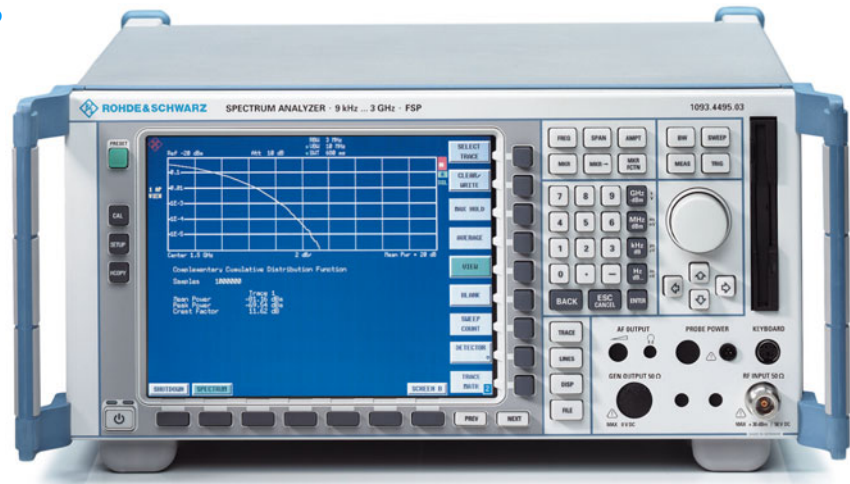
*Spectrum Analyzer R&S®FSP3*

## Brief description

The R&S®FSP family sets the standard for the medium class regarding the vital criteria of functionality, measurement speed and accuracy. The use of innovative techniques such as an highly integrated front-end and fully digital signal processing in the back end, together with ASICs developed by Rohde&Schwarz, has resulted in a product of top-class specifications and high reliability.

All important functions and interfaces are implemented as standard. R&S®FSP features future-oriented characteristics such as an RMS detector and a CCDF routine for fast statistical measurements on digitally modulated signals not offered by any other medium-class spectrum analyzer. The R&S®FSP Spectrum Analyzers are outstanding for their innovative measurements and a host of standard functions. Instead of a wide choice of options, R&S®FSP offers as standard all the functions and interfaces you may expect from a state-of-the art spectrum analyzer.

## Main features

- ◆ Largest colour display in its class
- ◆ Resolution bandwidths from 1 Hz to 10 MHz
- ◆ Highly selective digital and FFT filters

- ◆ Quasi-peak detector and EMI bandwidths
- ◆ Convenient documentation of results as a hardcopy or PC-compatible file
- ◆ GPIB, Centronics, RS-232-C, USB
- ◆ Automatic test routines for measuring TOI, OBW, phase noise and ACP(R), multi carrier ACP
- ◆ Split screen with separate settings and up to 3 traces per screen
- ◆ Editable limit lines including PASS/FAIL indication
- ◆ Fast measurements in the time domain: minimum sweep time 1  $\mu$ s
- ◆ Gated sweep for measurements on TDMA signals
- ◆ RMS detector for fast and reproducible power measurements on digitally modulated signals in frequency and time domain
- ◆ Statistical measurement functions for determining crest factor and CCDF (complementary cumulative distribution function)
- ◆ State-of-the-art spectrum analysis at an extremely attractive price-performance ratio

## Characteristics

## Speed

Time is a finite resource – so high measurement speed is indispensable for competitiveness and cost-effective testing.

Here, too, the new R&S®FSP offers characteristics that make it top of the class:

- ◆ Up to 55 measurements/s on GPIB interface including trace transfer of 501 binary data
- ◆ 80 measurements/s on GPIB interface in zero span mode including trace transfer of 501 binary data
- ◆ Minimum sweep time of 2.5 ms
- ◆ 1  $\mu$ s time domain measurements
- ◆ Special list mode for fastest measurement times on GPIB interface
- ◆ Unique fast ACP mode for high-speed ACPR measurements in time domain using the standard-stipulated test filters

With up to 100 measurements/s in manual operation and digital filters with sweep time 2.5 times faster than comparable analog filters, R&S®FSP will also help in your day-to-day work to develop your product much faster.

## Performance

Modern communication systems are required to achieve optimum spectral efficiency at high data rates. For the 3rd generation of CDMA mobile radio systems currently under development this is achieved, among other things, by high-precision power control.



Contents Overview

Chapter Overview

Type Index

R&amp;S Addresses







Contents Overview

Chapter Overview

Type Index

R&S Addresses



## Spectrum Analyzers R&S® FSP

R&S® FSP is the ideal partner in development and production, featuring the smallest level measurement uncertainty of all spectrum analyzers on the market, as well as excellent RF characteristics:

- ◆ 0.5 dB total measurement uncertainty allows higher tolerances for the DUT, thus increasing production yield
- ◆ 0.07 dB linearity uncertainty (1  $\sigma$ ) is ideal for precise measurements, for example of gain control and ACPR
- ◆ RMS detector with 100 dB dynamic range measures power fast and accurately irrespective of the signal shape – almost like a thermal power sensor
- ◆ The displayed average noise level of typ. -155 dBm (1 Hz) is attained without the use of preamplifiers and thus without any reduction in dynamic range
- ◆ Typ. -145 dBc (1 Hz) phase noise at 10 MHz offset offers optimum conditions for ACPR measurements on W-CDMA systems

Resolution bandwidths of up to 100 kHz are fully digital and provide – in addition to high selectivity – an ideal basis for accurate (adjacent-) channel measurements thanks to a maximum bandwidth deviation of 3%.

### Open for the PC world ...

- ◆ PC-compatible screenshots, no conversion software needed
- ◆ Windows™ printer support
- ◆ LabWindows driver
- ◆ LabView driver
- ◆ SCPI-compatible
- ◆ R&S® FSE/R&S® FSIQ-compatible GPIB command set

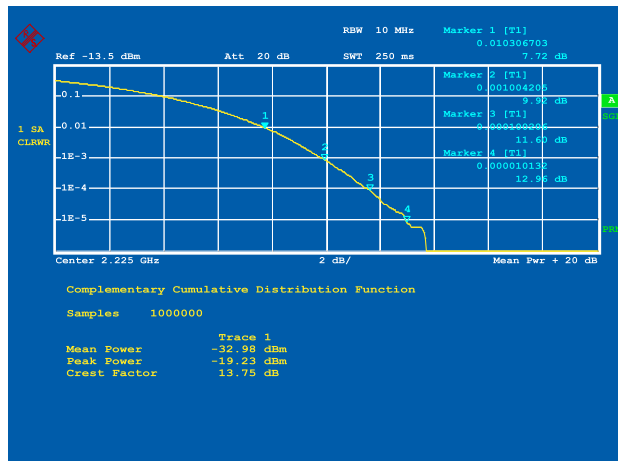

*R&S® FSP is the first spectrum analyzer to offer statistical analysis of signals by means of the complementary cumulative distribution function (CCDF) as standard and at an impressively high speed. FSP furnishes in only 250 ms the exact CCDF characteristic, average and peak power as well as the crest factor over 1 million measured values*

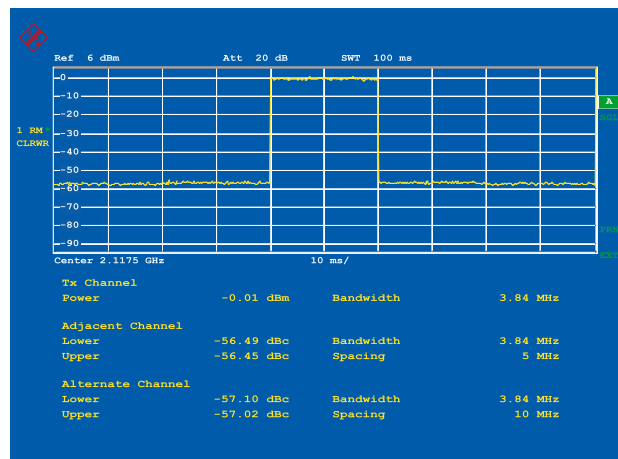

*Adjacent-channel power ratio (ACPR) measurements, which many mobile radio standards stipulate for components and units, are implemented in R&S® FSP by means of automatic test routines; all settings, measurements and filters required for a selected standard are activated at a keystroke*

### 859x/8566-compatible IEC/IEEE bus command set

The R&S® FSP comes standard with an IEC/IEEE bus command set that is compatible not only with the R&S® FSEx/FSIQ family but also with the spectrum analyzers of the 859x/8566 series.

- ◆ Approx. 175 commands in IEEE488-2 format (incl. CF, AT, ST)
  - ◆ The most important commands in IEEE488-1 format (8566A, for exclusive use only)
  - ◆ Selectable presets
  - ◆ Selectable trace format
- 8560E to 8565E, 8566A/B, 8568A/B and 8594E are supported. The IEC/IEEE bus commands in IEEE488-2 format can be used together with the R&S® FSP command set.

### Electronic attenuator for high production throughput

The optional Electronic Attenuator R&S® FSP-B25 (only for R&S® FSP3 and R&S® FSP7) supplements the standard mechanical attenuator and provides a setting range of 30 dB in 5 dB steps. The integrated switchable 20-dB preamplifier allows high-sensitivity measurements in the useful frequency range from 10 MHz to 7 GHz.

### LAN interface

With the aid of the optional LAN Interface R&S® FSP-B16, R&S® FSP can be connected to common networks such as 100Base-T. In addition, R&S® FSP can be remote-controlled via LAN.



Contents Overview

Chapter Overview

Type Index

R&S Addresses





Contents Overview

Chapter Overview

Type Index

R&amp;S Addresses



## Spectrum Analyzers R&amp;S® FSP

## Specifications in brief

You will find detailed and binding data on the enclosed CD (./DATASHEET/FSP.pdf), or, for the latest updates, visit [www.rohde-schwarz.com](http://www.rohde-schwarz.com), search term: FSP

## Frequency

	R&S® FSP3	FSP7	FSP13	FSP30	FSP40
Frequency range	9 kHz to 3 GHz	7 GHz	13.6 GHz	30 GHz	40 GHz
Frequency resolution	0.01 Hz				
Frequency display	with marker or frequency counter				
Marker resolution	span/500				
Frequency counter resolution	0.1 Hz to 10 kHz (selectable)				
Frequency span 0 Hz, 10 Hz to	3 GHz	7 GHz	13.6 GHz	30 GHz	40 GHz
Max. span deviation	0.1%				

## Spectral purity

SSB phase noise, f = 500 MHz					
Carrier offset 10 kHz	typ. -113 (dBc (1 Hz))				
Carrier offset 10 MHz	typ. -145 (dBc (1 Hz))				
Residual FM, f = 500 MHz, RBW 1 kHz,					
Sweep time 100 ms	typ. 3 Hz				

## Sweep time

Span ≥ 10 Hz	2.5 ms to 16000 s in steps of 10%				
Span 0 Hz	1 μs to 16000 s in steps of 5%				

## Typical values for SSB phase noise (referred to 1 Hz bandwidth)

Offset	$f_{in}=3\text{ GHz}$	$f_{in}=7\text{ GHz}$	$f_{in}=13\text{ GHz}$	$f_{in}=22\text{ GHz}$	$f_{in}=26\text{ GHz}$	$f_{in}=40\text{ GHz}$
10 kHz	-108 dBc	-104 dBc	-98 dBc	-94 dBc	-92 dBc	-91 dBc
1 MHz	-118 dBc	-118 dBc	-112 dBc	-108 dBc	-106 dBc	-102 dBc

## Resolution bandwidths

Bandwidths (-3 dB)	10 Hz to 10 MHz, in 1, 3 sequences
EMI bandwidths (-6 dB)	200 Hz, 9 kHz, 120 kHz
Video bandwidths	1 Hz to 10 MHz in 1, 3 sequences
FFT filter bandwidths (-3 dB)	1 Hz to 30 kHz in 1, 3 sequences
Channel filters (bandwidths)	100/200/300/500 Hz, 1/1.5/2/2.4/2.7/3/3.4/4/4.5/5/6/8.5/9/10/12.5/ 14/15/16/18 (RRC)/20/21/24.3 (RRC)/25/30/50/ 100/150/192/200/300/500 kHz, 1/1.228/1.5/2/3/5 MHz

## Level

## 1 dB compression of input mixer

RF attenuation	0 dB nominal
0 dB, f > 200 MHz	

## Intermodulation

3rd-order intermodulation  
Intermodulation-free dynamic range, level  $2 \times -30\text{ dBm}$ ,  $\Delta f > 5 \times \text{RBW}$  or 10 kHz, whichever the greater value

	R&S®	FSP3	FSP7	FSP13	FSP30	FSP40
200 MHz to 3 GHz	>74 dBc, TOI typ. >10 dBm					
3 GHz to 7 GHz	>80 dBc, TOI typ. >15 dBm					
7 GHz to 20 GHz	>80 dBc, TOI >10 dBm					
with optional Electronic Attenuator R&S® FSP-B25 switched on						

	R&S®	FSP3	FSP7	FSP13	FSP30	FSP40
<b>Second harmonic intercept point (SHI)</b>						
100 MHz to 3 GHz	>35 dBm					
3 GHz to 7 GHz	>45 dBm					
7 GHz to 13.6 GHz	typ. 45 dBm					
13.6 GHz to 30 GHz	typ. 45 dBm					
30 GHz to 40 GHz	typ. 45 dBm					

## Displayed average noise level (dBm)

(0 dB RF attenuation, RBW 10 Hz, VBW 1 Hz, 20 averages, trace average, span 0 Hz, termination 50 Ω)

10 MHz to 1 GHz	typ. <-145	typ. -145				
1 GHz to 3 GHz	typ. <-145	typ. -143				
3 GHz to 7 GHz	-	typ. <-143	typ. <-145			<-135
7 GHz to 13.6 GHz	-	-	typ. <-138			<-132
13.6 GHz to 20 GHz	-	-	-	-	-	<-120
13.6 GHz to 22 GHz	-	-	-	-	typ. -130	-
20 GHz to 30 GHz	-	-	-	-	-	<-120
22 GHz to 30 GHz	-	-	-	-	typ. -123	-
30 GHz to 40 GHz	-	-	-	-	-	<-112

## Displayed average noise level with preamplifier on (option R&amp;S® FSP-B25)

10 MHz to 2 GHz	<-152 dBm	-				
2 GHz to 7 GHz	<-150 dBm	-				

## Immunity to interference

Image frequency	>70 dB
Intermediate frequency (f < 3 GHz)	>70 dB
Spurious response (f > 1 MHz, without input signal, 0 dB attenuation)	<-103 dBm

## Level display

Screen	501 × 400 pixels (one diagram), max. 2 diagrams with independent settings
Log level scale	10 dB to 200 dB, in steps of 10 dB
Linear level scale	10% of reference level per level division, 10 divisions
Traces	max. 3, with two diagrams on screen max. 3 per diagram
Trace detector	Max peak, Min Peak, Auto Peak, Sample, Quasi-Peak, Average, RMS
Trace functions	Clear/Write, Max/Min Hold, Average
Number of measurement points	501, settable in steps of factor 2, from 125 to 8001

## Setting range of reference level

Logarithmic level display	-130 dBm to 30 dBm, in steps of 0.1 dB
Linear level display	70.71 nV to 7.07 V in steps of 1%

## Max. uncertainty of level measurement

At 128 MHz, -30 dBm (RF attenuation 10 dB, RBW 10 kHz, ref. level -20 dBm)	<0.2 dB
--	---------

	R&S®	FSP3	FSP7	FSP13	FSP30	FSP40
<b>Frequency response</b>						
<50 kHz	<+0.5/-1.0 dB					
50 kHz to 3 GHz	<0.5 dB					
3 GHz to 7 GHz	-	<2 dB	-	-	-	-
7 GHz to 13.6 GHz	-	-	<2.5 dB			
13.6 GHz to 30 GHz	-	-	<3 dB			
30 GHz to 40 GHz	-	-	-	-	-	<4 dB
Attenuator	<0.2 dB					
Reference level switching	<0.2 dB					

## Display nonlinearity LOG/LIN (S/N &gt; 16 dB)

RBW ≤ 100 kHz, 0 dB to -70 dB	<0.2 dB
RBW ≥ 300 kHz, 0 dB to -50 dB	<0.2 dB



Contents Overview

Chapter Overview

Type Index

R&amp;S Addresses





## Spectrum Analyzers R&amp;S® FSP

## Bandwidth switching uncertainty (ref. to RBW = 10 kHz)

10 Hz to 100 kHz	<0.1 dB
300 kHz to 10 MHz	<0.2 dB
1 Hz to 3 kHz, FFT	<0.2 dB

## Total measurement uncertainty

0 GHz to 3 GHz	0.5 dB
----------------	--------

## Data of options

## Tracking Generator R&amp;S® FSP-B9

Frequency range	9 kHz to 3 GHz
Frequency offset setting range	±150 MHz
Spectral purity	
SSB phase noise, f = 500 MHz, carrier offset 100 kHz, normal mode	-90 dBc (1 Hz) typ.
Level range	-30 dBm to 0 dBm in 0.1 dB steps
Frequency response, output level 0 dBm, 100 kHz to 2 GHz	<1 dB
Dynamic range, attenuation measurement range, RBW=1 kHz, f >10 MHz	120 dB

## Electronic Attenuator R&amp;S® FSP-B25 (only for R&amp;S® FSP3/FSP7)

Frequency range	10 MHz to 7 GHz
Input attenuator range (mechanical)	0 dB to 75 dB in 5 dB steps
Electronic attenuation range	0 dB to 30 dB in 5 dB steps
Preamplifier	20 dB, switchable
Max. deviation of level measurement	
Preamplifier on	<0.2 dB
Electronic attenuator	<0.2 dB
Frequency response with preamplifier, electronic attenuator	
10 MHz to 3 GHz	<1 dB
3 GHz to 7 GHz	<2 dB

## General data

Display	21 cm TFT colour display (8.4", VGA)
Operating temperature range	+5°C to +40°C
Power supply	100 V AC to 240 V AC, 50 Hz to 400 Hz, 3.1 A to 1.3 A
Power consumption	70 VA to 150 VA (dep. on model)
Dimensions (W × H × D)	412 mm × 197 mm × 417 mm
Weight	12 kg to 13.5 kg (dep. on model)

## Ordering information

Spectrum Analyzer		
9 kHz to 3 GHz	R&S® FSP3	1164.4391.03
9 kHz to 7 GHz	R&S® FSP7	1164.4391.07
9 kHz to 13.6 GHz	R&S® FSP13	1164.4391.13
9 kHz to 30 GHz	R&S® FSP30	1164.4391.30
9 kHz to 40 GHz	R&S® FSP40	1164.4391.40

## Accessories supplied

Power cable, operating manual, service manual		
---	--	--

## Options

Rugged Case, carrying handle (factory-fitted)	R&S® FSP-B1	1129.7998.02
AM/FM Audio Demodulator	R&S® FSP-B3	1129.6491.02
OCXO Reference Frequency	R&S® FSP-B4	1129.6740.02
TV Trigger/RF Power Trigger	R&S® FSP-B6	1129.859.4.02

Internal Tracking Generator 9 kHz to 3 GHz, I/Q modulator	R&S® FSP-B9	1129.6991.02
External Generator Control	R&S® FSP-B10	1129.7246.02
Pulse Calibrator (not with R&S® FSP-B3)	R&S® FSP-B15	1155.1006.02
LAN Interface 100BT for all R&S® FSP models with Windows XP (1164.4391.xx) with Windows NT (1043.4495.xx)	R&S® FSP-B16 R&S® FSP-B16	1129.8042.03 1129.8042.02
Extended Environmental Specification (only factory fitted)	R&S® FSP-B20	1155.1606.06
LO/IF Ports for External Mixers (only retrofittable in R&S® FSP40, 1164.4391.40)	R&S® FSU-B21	1157.1090.02
Electronic Attenuator, 0 dB to 30 dB, integrated preamplifier, for R&S® FSP3 and R&S® FSP7	R&S® FSP-B25	1129.7746.02
Trigger Port for indication of trigger conditions	R&S® FSP-B28	1162.9915.02
DC Power Supply	R&S® FSP-B30	1155.1158.02
Battery Pack (R&S® FSP-B1 and -B30 required)	R&S® FSP-B31	1155.1258.02
Spare Battery Pack (R&S® FSP-B31 required)	R&S® FSP-B32	1155.1506.02
Demodulation Hardware and Memory Extension (R&S® FSP-B15 required)	R&S® FSP-B70	1157.0559.02

## Software/Firmware

Noise Measurement Software	R&S® FS-K3	1057.3028.02
Application Firmware for Noise Figure and Gain Measurements	R&S® FS-K30	1300.6508.02
Phase Noise Measurement Software	R&S® FS-K4	1108.0088.02
GSM/EDGE Application Firmware, mobile	R&S® FS-K5	1141.1496.02
AM/FM Measurement Demodulator	R&S® FS-K7	1141.1796.02
3GPP BTS/Node B FDD Application Firmware	R&S® FS-K72	1154.7000.02
3GPP-FDD UE Transmitter Test	R&S® FS-K73	1154.7252.02
3GPP HSDPA BTS Application Firmware	R&S® FS-K74	1300.7156.02
3GPP TD-SCDMA BTS Application Firmware	R&S® FS-K76	1300.7291.02
3GPP TD-SCDMA UE Application Firmware	R&S® FS-K77	1300.8100.02
Bluetooth® Application Firmware	R&S® FS-K8	1141.2568.02
cdma2000 Base Station Test Application Firmware	R&S® FS-K82	1154.7252.02
cdma2000 1xEV-DO BTS Application Firmware	R&S® FS-K84	1157.2851.02
cdma2000-1xEV-DO MS Application Firmware	R&S® FS-K85	1300.6689.02
Power Sensor Measurements (supports R&S® NRP-Z11/-Z21 with R&S® NRP-Z4 USB connector)	R&S® FS-K9	1157.3006.02
WLAN 802.11a TX Measurements Application Firmware	R&S® FSP-K90	1300.6650.02

## Recommended extras

Headphones	–	0708.9010.00
US Keyboard with trackball	R&S® PSP-Z2	1091.4100.02
DC Block, 10 kHz to 18 GHz (type N)	R&S® FSE-Z4	1084.7443.02
IEC/IEEE-Bus Cable, xx 10/20/40 = 1/2/4 m	R&S® PCK	0292.2013.xx
19" Rack Adapter (not for R&S® FSP-B1)	R&S® ZZA-478	1096.3248.00
Transit bag	R&S® ZZT-473	1109.5048.00
Matching Pads, 75 Ω		
L Section	R&S® RAM	0358.5414.02
Series Resistor, 25 Ω	R&S® RAZ	0358.5714.02
SWR Bridge, 5 MHz to 3000 MHz	R&S® ZRB2	0373.9017.52
SWR Bridge, 40 kHz to 4 GHz	R&S® ZRC	1039.9492.52
High-Power Attenuators, 100 W 3/6/10/20/30 dB (xx = 03/06/10/20/30)	R&S® RBU 100	1073.8820.xx
High-Power Attenuators, 50 W 3/6/10/20/30 dB (xx = 03/06/10/20/30)	R&S® RBU 50	1073.8695.xx
For R&S® FSP30		
Test Port Adapter, 3.5 mm male	–	1021.0529.00
Test Port Adapter, N male	–	1021.0541.00
Microwave Meas. Cable and Adapter Set	R&S® FS-Z15	1046.2002.02
For R&S® FSP40		
Test Port Adapter K male	–	1036.4802.00
Test Port Adapter N male	–	1036.4783.00
Test Port Adapter 2.4 mm female	R&S® FSE-Z5	1088.1627.02



## Spectrum Analyzer R&amp;S®FSU

20 Hz to 50 GHz

High-end spectrum analyzer with unmatched performance

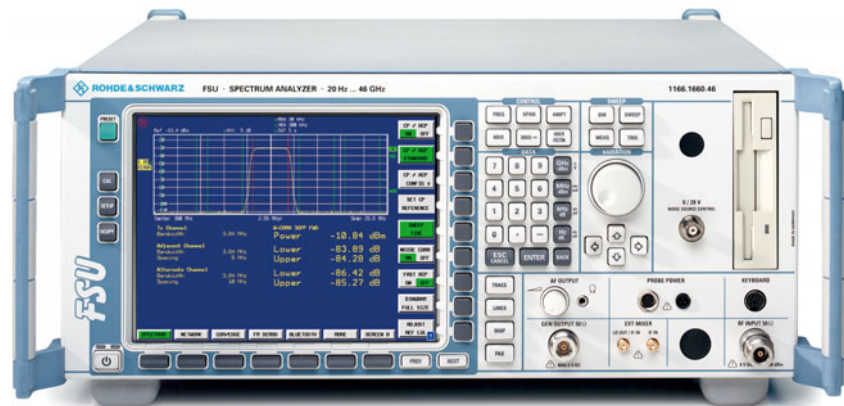
*Spectrum Analyzer R&S®FSU46*

## Brief description

Measurements calling for an extremely wide dynamic range become even simpler, faster and more reliable – in design, quality management and production. R&S®FSU can rightly be called the new reference in spectrum analysis, with an unprecedented dynamic range:

- ◆ TOI >20 dBm, typ. 25 dBm
- ◆ 1 dB compression point (0 dB RF attenuation): +13 dBm
- ◆ Displayed average noise level: –158 dBm (1 Hz bandwidth)
- ◆ Typ. 77 dB ACLR for 3GPP
- ◆ HSOI typ. 55 dBm
- ◆ Typ. phase noise: –160 dBc (1 Hz) at 10-MHz carrier offset

These characteristics make it easy to find small spurious signals even in the presence of strong carriers (e.g. at a base station). For 3GPP adjacent-channel power measurements, a figure of 84 dB ACLR allows good adjacent-channel power ratios to be verified and demonstrated very simply and with high accuracy. The high harmonic second-order intercept point means optimum dynamic range for multichannel cable TV measurements.

## Main features

Even in its basic version, R&S®FSU offers the functionality and characteristics

needed to design, verify and produce 3G mobile radio systems:

- ◆ Time-domain power in conjunction with channel or RRC filters makes R&S®FSU a fully-fledged channel power meter
- ◆ Versatile channel/adjacent-channel power measurement functions with wide selection of standards, user-configurable
- ◆ CCDF measurement function
- ◆ 2.5 ms sweep time in frequency domain
- ◆ 1  $\mu$ s sweep time in time domain
- ◆ Measurement points/trace selectable from 155 to 10001
- ◆ Time-selective spectrum analysis with gating function
- ◆ Fast ACP measurement in time domain
- ◆ Statistical signal analysis with CCDF function
- ◆ Transducer factor
- ◆ Fast ACP test routine in time domain
- ◆ User-configurable list for fast measurements at frequencies of interest
- ◆ Up to 60 measurements/s in time domain via IEC/IEEE bus (including trace data transfer)
- ◆ Fast time domain power measurement using channel or RRC filters
- ◆ Full choice of detectors for adaptation to a wide range of signal types
  - RMS (dynamic range 100 dB)
  - AUTO, MIN/MAX, QUASI PEAK
  - SAMPLE, AVERAGE

The most versatile resolution filter characteristics and largest bandwidth found in a spectrum analyzer:

- ◆ Standard resolution filters from 10 Hz to 50 MHz in steps of 1, 2, 3, 5
- ◆ 32 channel filters with bandwidth from 100 Hz to 5 MHz (DAB)
- ◆ RRC filters for NADC and TETRA
- ◆ EMI filters: 200 Hz, 9 kHz, 120 kHz
- ◆ Fast FFT filters from 1 Hz to 30 kHz

## Full range of analysis functions

- ◆ TOI marker
- ◆ Noise/phase-noise marker
- ◆ Split-screen mode with selectable settings
- ◆ CCDF measurement function
- ◆ Peak list marker for fast search of all peaks within selected frequency range

## Flexible data interchangeability

- ◆ Standard LAN interface (Ethernet 10/100 BaseT)
- ◆ Network capable workstation by Embedded Windows XP
- ◆ All elements of the R&S®FSU screen are represented by a soft front panel function; the complete R&S®FSU screen shows on the remote PC
- ◆ Special RSIB interface (Windows and UNIX) links the user's application to the TCP/IP protocol and acts like an IEC/IEEE-bus driver
- ◆ USB interface
- ◆ Integrated standard disk drive



Contents Overview

Chapter Overview

Type Index

R&S Addresses



## Spectrum Analyzer R&S®FSU

### Specifications in brief

You will find detailed and binding data on the enclosed CD (./DATASHEET/FSU.pdf), or, for the latest updates, visit [www.rohde-schwarz.com](http://www.rohde-schwarz.com), search term: FSU

#### Frequency

	R&S® FSU3/8	R&S® FSU26/46/50
<b>Frequency range</b>		
DC coupled	20 Hz to 3.6/8 GHz	20 Hz to 26.5/46/50 GHz
AC coupled	1 MHz to 3.6/8 GHz	10 MHz to 26.5/46/50 GHz
Frequency resolution	0.01 Hz	
Frequency display	with marker or frequency counter	
Frequency span	0 Hz, 10 Hz to 3.6/8 GHz	0 Hz, 10 Hz to 26.5/46/50 GHz
<b>Spectral purity (dBc (1 Hz)), SSB phase noise, f = 640 MHz</b>		
Carrier offset		
10 Hz	typ. -73 dBc (1 Hz), with option R&S®FS-B4	typ. -86 dBc
10 kHz	typ. -123 dBc (1 Hz)	
10 MHz	typ. -160 dBc (1 Hz)	
<b>Sweep</b>		
Span 0 Hz	1 μs to 16000 s in steps of 5%	
Span ≥10 Hz	2.5 ms to 16000 s in steps ≤10%	
<b>Resolution bandwidth</b>		
Analog filters		
3 dB bandwidths	10 Hz to 20 MHz in 1/2/3/5 sequence, 50 MHz	
Video bandwidths	1 Hz to 10 MHz in 1/2/3/5 sequence	
FFT filters (-3 dB)	1 Hz to 30 kHz in 1/2/3/5 sequence	
EMI filters (-6 dB)	200 Hz, 9 kHz, 120 kHz	
Channel filters (bandwidths)	100/200/300/500 Hz, 1/1.5/2/2.4/2.7/3/3.4/4/4.5/5/6/8.5/9/10/12.5/14/15/16/18 (RRC)/20/21/24.3 (RRC)/25/30/50/100/150/192/200/300/500 kHz, 1/1.228/1.5/2/3/5 MHz	

#### Level

<b>1 dB compression of input mixer</b> (0 dB RF attenuation)		
≤3.6 GHz	13 dBm	13 dBm
>3.6 GHz	-10 dBm	7 dBm
<b>Intermodulation</b>		
Third-order intermodulation (TOI), level 2 × -10 dBm, Δf >5 × RBW or 10 kHz, whichever is the greater value, typical values)		
300 MHz to 3.6 GHz	25 dBm	27 dBm
3.6 GHz to 26.5 GHz	-	15 dBm
<b>Second harmonic intercept point (SHI)</b>		
400 MHz < f <sub>in</sub> ≤500 Hz	typ. 60 dBm	
<b>Maximum dynamic range</b>		
1 dB compression to DANL (1 Hz)	170 dB	
<b>Immunity to interference</b>		
Image frequency, f ≤3.6 GHz	>90 dB, typ. >110 dB	
Intermediate frequency, ≤3.6 GHz	>90 dB, typ. >110 dB	
Spurious responses (f > 1 MHz, without input signal, 0 dB attenuation)	<-103 dBm	
<b>Level display (spectrum mode)</b>		
Screen	625 × 500 pixels (one diagram), max. 2 diagrams with independent settings	
Logarithmic level axis	1 dB, 10 dB to 200 dB in steps of 10 dB	
Linear level axis	10% of reference level per level division, 10 divisions or logarithmic scaling	

	R&S® FSU3/8	R&S® FSU26/46/50
Traces	max. 6, with two diagrams on screen, max. 3 per diagram	
Trace detector	Max Peak, Min Peak, Auto Peak (normal), Sample, RMS, Average, Quasi Peak	
Number measurement points	625 (default value), range 155 to 10001 in steps of about a factor of 2	
Trace functions	Clear/Write, Max Hold, Min Hold, Average	
<b>Setting range of reference level</b>		
Logarithmic level display	-130 dBm to (+5 dBm + RF attenuation), max. 30 dBm, in steps of 0.1 dB	
Linear level display	7.0 nV to 7.07 V in steps of 1%	

#### Displayed average noise level

(0 dB RF attenuation, RBW 10 Hz, VBW 30 Hz, 20 averages, trace average, span 0 Hz, termination 50 Ω, typical values)

	R&S®	FSU3	FSU8	FSU26	FSU46	FSU50
10 MHz ≤ f < 2 GHz	-148 dBm	-148 dBm	-146 dBm	-146 dBm	-146 dBm	-146 dBm
2 GHz ≤ f < 3 GHz	-147 dBm	-145 dBm	-	-	-	-
2 GHz ≤ f < 3.6 GHz	-143 dBm	-	-	-	-	-
2 GHz ≤ f < 13 GHz	-	-	-	-143 dBm	-143 dBm	-
3 GHz ≤ f < 3.6 GHz	-146 dBm	-	-	-	-	-
3 GHz ≤ f < 7 GHz	-	-144 dBm	-	-	-	-
3.6 GHz ≤ f < 8 GHz	-	-	-146 dBm	-	-	-
7 GHz ≤ f < 8 GHz	-	-142 dBm	-	-	-	-
8 GHz ≤ f < 13 GHz	-	-	-143 dBm	-	-	-
13 GHz ≤ f < 18 GHz	-	-	-141 dBm	-141 dBm	-141 dBm	-141 dBm
18 GHz ≤ f < 22 GHz	-	-	-140 dBm	-140 dBm	-140 dBm	-140 dBm
22 GHz ≤ f < 26.5 GHz	-	-	-138 dBm	-138 dBm	-138 dBm	-138 dBm
26.5 GHz ≤ f < 32 GHz	-	-	-	-	-	-131 dBm
26.5 GHz ≤ f < 40 GHz	-	-	-	-131 dBm	-	-
32 GHz ≤ f < 46 GHz	-	-	-	-	-	-126 dBm
40 GHz ≤ f < 46 GHz	-	-	-	-128 dBm	-	-
46 GHz ≤ f < 50 GHz	-	-	-	-	-	-121 dBm

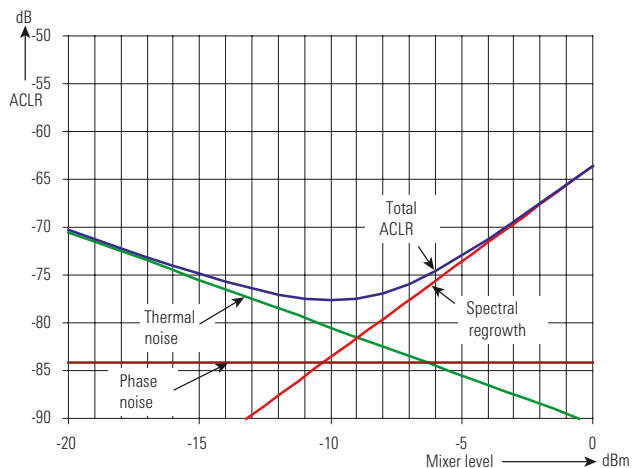

**R&S® FSU dynamic range for adjacent-channel power measurement on WCDMA signal without using noise correction; noise correction enhances the dynamic range to 84 dB**



Contents Overview

Chapter Overview

Type Index

R&S Addresses



## Spectrum Analyzer R&amp;S®FSU

Level measurement error	
Reference error at 128 MHz, RBW ≤100 kHz, reference level –30 dBm	
RF attenuation 10 dB	<0.2 dB
Frequency response (DC coupling, RF attenuation ≥ 10 dB)	
10 MHz to 3.6 GHz	<0.3 dB
22 GHz to 26.5 GHz	– <2.5 dB
Attenuator (≥5 dB)	<0.2 dB
Reference level switching	<0.15 dB
Display nonlinearity (+20°C to +30°C, mixer level = –10 dBm)	
Logarithmic level display, RBW = 100 kHz or channel filters,	
S/N >20 dB, 0 dB to –70 dB	<0.1 dB (s = 0.03 dB)
200 kHz = RBW = 10 MHz, S/N >16 dB	
0 dB to –50 dB	<0.2 dB (s = 0.07 dB)
RBW >10 MHz, S/N >16 dB	
0 dB to –50 dB	<0.5 dB (s = 0.17 dB)
Linear level display	5% of reference level
Bandwidth switching error referenced to RBW = 10 kHz	
1 Hz to 100 kHz	<0.1 dB (s = 0.03 dB)
200 kHz to 3 MHz	<0.2 dB (s = 0.07 dB)
5 MHz to 50 MHz	<0.5 dB (s = 0.15 dB)
FFT filter 1 Hz to 3 kHz	<0.2 dB (s = 0.07 dB)
Total measurement uncertainty	
(0 dB to –70 dB, S/N >20 dB, span/RBW <100, 95 % confidence level) (20°C to 30°C, mixer level ≤–10 dBm)	
f < 3.6 GHz	0.3 dB (RBW ≤100 kHz) 0.5 dB (RBW >100 kHz)
3.6 GHz ≤ f < 8 GHz	2.0 dB
8 GHz ≤ f < 18 GHz	2.5 dB
18 GHz ≤ f < 26.5 GHz	3.0 dB
26.5 GHz ≤ f < 40 GHz	3.0 dB
40 GHz ≤ f < 50 GHz	3.5 dB

## Trigger

Span ≥10 Hz, Span = 0 Hz	
Trigger source	free run, video, ext., IF level (mixer level >–20 dBm)
Trigger offset	125 ns to 100 s
Gated sweep	
Trigger source	external, IF level, video
Gate delay	1 μs to 100 s
Gate length	125 ns to 100 s

## General data

Display	21 cm TFT LCD colour display (8.4", SVGA)
Mass memory	1.44 Mbyte 3½" disk drive, hard disk
Data storage	>500 instrument settings and traces
Remote control	interface to IEC625-2 (IEEE488.2)
Serial interface	RS-232-C (COM), 9-pin Sub-D female
Printer interface	parallel (Centronics-compatible)
Rated temperature range	+5°C to +40°C
AC power supply	100 V AC to 240 V AC, 3.1 A to 1.3 A, 50 to 400 Hz
Power consumption	typ. 140 VA
Dimensions (W x H x D)	435 mm x 192 mm x 460 mm
Weight	15 kg

Tracking Generator R&S®FSU-B9,  
Attenuator R&S®FSU-B12 for Tracking Generator

Frequency range	100 kHz to 3.6 GHz
Frequency offset (setting range)	200 MHz
Level setting range	–30 dBm to +5 dBm in steps of 0.1 dB
With option R&S®FSU-B12	–100 dBm to +5 dBm in steps of 0.1 dB
Max. deviation of output level (absolute, f = 128 MHz, –20 dBm to 0 dBm)	<1 dB
Frequency response (referenced to level at 128 MHz, sweep time >100 ms, –20 dBm to 0 dBm, 100 kHz to 3.6 GHz)	<3 dB, typ. 1.9 dB
Dynamic range (attenuation measurement range, RBW = 1 kHz, f >10 MHz)	100 dB
Modulation format (external)	I/Q, AM, FM
AM (modulation depth)	0% to 99%
FM (frequency deviation)	0 Hz to 10 MHz
Modulation frequency range	0 Hz to 100 kHz (deviation <1 MHz)
I/Q modulation (modulation frequency response, 0 Hz to 5 MHz)	1 dB

## Optional Electronic Attenuator R&amp;S®FSU-B25

Electronic attenuator	0 dB to 30 dB, 5 dB steps
Preamplifier	20 dB, switchable
Maximum level measurement error (frequency response, with preamplifier or electronic attenuator)	
10 MHz to 50 MHz	<1 dB
50 MHz to 3.6 GHz	<0.6 dB
3.6 GHz to 8 GHz	<2.0 dB
Reference error at 128 MHz, RBW ≤100 kHz, reference level –30 dBm, RF attenuation 10 dB	
Electronic attenuator	<0.3 dB
Preamplifier	<0.3 dB
Displayed average noise level (RBW = 1 kHz, VBW = 3 kHz, zero span, sweep time 50 ms, 20 averages, mean marker, normalized to 10 Hz RBW, preamplifier on)	
10 MHz to 2.0 GHz	<–152 dBm
2.0 GHz to 3.6 GHz	<–150 dBm
3.6 GHz to 8.0 GHz	<–147 dBm
Intermodulation (third-order intermodulation, third-order intercept (TOI), electronic attenuator on, Δf > 5 × RBW or 10 kHz)	
10 MHz to 300 MHz	>17 dBm
300 MHz to 3.6 GHz	>20 dBm
3.6 GHz to 8 GHz	>18 dBm

## RF Preamplifier R&amp;S®FSU-B23

Displayed average noise level (RBW = 1 kHz, VBW = 3 kHz, zero span, sweep time 50 ms, trace average, sweep count = 20, mean marker, normalized to 10 Hz RBW, preamplifier = on)	
3.6 GHz to 8 GHz	typ. –155 dBm
22 GHz to 26.5 GHz	typ. –145 dBm

## LO/IF Ports for External Mixers R&amp;S®FSU-B21

LO signal (Frequency range)	7.0 GHz to 15.5 GHz
Level (+20°C to +30°C)	+15.0 dBm ±1 dB
IF input	404.4 MHz
Full scale level	–20 dBm
Level uncertainty, IF input level	<1 dB
–30 dBm, RBW 30 kHz, +20 to +30°C	



Contents Overview

Chapter Overview

Type Index

R&amp;S Addresses



## Spectrum Analyzer R&amp;S®FSU

## Ordering information

Spectrum Analyzer		
20 Hz to 3.6 GHz	R&S®FSU3	1166.1660.03
20 Hz to 8 GHz	R&S®FSU8	1166.1660.08
20 Hz to 26.5 GHz	R&S®FSU26	1166.1660.26
20 Hz to 46.5 GHz	R&S®FSU46	1166.1660.46
20 Hz to 50 GHz	R&S®FSU50	1166.1660.50

## Accessories supplied

Power cable, operating manual, service manual,  
 R&S®FSU26: test port adapter with 3.5 mm female (1021.0512.00) and N female (1021.0535.00) connector  
 R&S®FSU46: test port adapter with K female (10366.4790.00) and N female (1036.4777.00) connector  
 R&S®FSU50: test port adapter with 2.4 mm female (1088.1627.02) and N female (1036.4777.00) connector

## Options

OCXO, low aging/improved phase noise at 10 Hz carrier offset	R&S®FSU-B4	1144.9000.02
Tracking Generator, 9 kHz to 3.6 GHz	R&S®FSU-B9	1142.8994.02
External Generator Control	R&S®FSP-B10	1129.7246.02
Output Attenuator, 0 dB to 70 dB, for R&S®FSU-B9 (requires R&S®FSU-B9)	R&S®FSU-B12	1142.9349.02
Removable Hard Disk (excludes R&S®FSU-B20, factory fitted only)	R&S®FSU-B18	1145.0242.0x
Second Hard Disk for R&S®FSU-B18 (requires R&S®FSU-B18)	R&S®FSU-B19	1145.0394.0x
Extended Environmental Specification (factory fitted only)	R&S®FSU-B20	1155.1606.08
LO/IF ports for external mixers (only for R&S®FSU26 and R&S®FSU46)	R&S®FSU-B21	1157.1090.02
20 dB Pre-amplifier, 3.6 GHz to 26.5 GHz (only for R&S®FSU26, requires R&S®FSU-B25, factory fitted only)	R&S®FSU-B23	1157.0907.02
Electronic Attenuator, 0 dB to 30 dB, integrated 20 dB pre-amplifier (3.6 GHz)	R&S®FSU-B25	1044.9298.02

## Firmware/Software

Noise Measurement Software (pre-amplifier, e.g. R&S®FSU-B25, recommended)	R&S®FS-K3	1057.3028.02
Application Firmware for Noise Figure and Gain Measurements	R&S®FS-K30	1300.6508.02
Phase Noise Measurement Software	R&S®FS-K4	1108.0088.02
GSM/EDGE Application Firmware	R&S®FS-K5	1141.1496.02
FM Measurement Demodulator	R&S®FS-K7	1141.1796.02
Bluetooth Application Firmware	R&S®FS-K8	1141.2568.02
Power Sensor Measurements	R&S®FS-K9	1157.3006.02
3GPP BTS/Node B FDD Application Firmware	R&S®FS-K72	1154.7000.02
3GPP-FDD UE Transmitter Test	R&S®FS-K73	1154.7252.02
3GPP HSDPA BTS Application Firmware	R&S®FS-K74	1300.7156.02
3GPP TD-SCDMA Application Firmware	R&S®FS-K76	1300.7291.02
cdma2000 Base Station Test Application Firmware	R&S®FS-K82	1157.2316.02
CDMA2000 MS Application Firmware	R&S®FS-K83	1157.2416.02
CDMA2000 1xEV-DO BTS Application Firmware	R&S®FS-K84	1157.2851.02
CDMA2000 1xEV-DO Mobile Station Test Application Firmware	R&S®FS-K85	1300.6689.02

## Recommended extras

Headphones		0708.9010.00
US Keyboard with trackball	R&S®PSP-Z2	1091.4100.02
IEC/IEEE-Bus Cable, 1 m	R&S®PCK	0292.2013.10
IEC/IEEE-Bus Cable, 2 m	R&S®PCK	0292.2013.20
19" Rack Adapter	R&S®ZZA-411	1096.3283.00
Adapter for mounting on telescopic rails (only with 19" Adapter R&S®ZZA-411)	R&S®ZZA-T45	1109.3774.00
Matching pads, 50/75 Ω		
L Section, matching at both ends	R&S®RAM	0358.5414.02
Series Resistor, 25 Ω, matching at one end (taken into account in instrument function RF INPUT 75 Ω)	R&S®RAZ	0358.5714.02
SWR Bridge, 5 MHz to 3 GHz, 50 Ω	R&S®ZRB2	0373.9017.5x
SWR Bridge, 40 kHz to 4 GHz, 50 Ω	R&S®ZRC	1039.9492.5x
High power attenuators		
100 W, 3/6/10/20/30 dB, 1 GHz (xx = 03/06/10/20/30)	R&S®RBU100	1073.8495.xx
50 W, 3/6/10/20/30 dB, 2 GHz (xx = 03/06/10/20/30)	R&S®RBU50	1073.8695.xx
50 W, 20 dB, 6 GHz	R&S®RDL50	1035.1700.52
Probe power connector, 3 pin		1065.9480.00
DC Block, 5 MHz to 7 GHz (Type N)	R&S®FSE-Z3	4010.3895.00
DC Block, 10 kHz to 18 GHz (Type N)	R&S®FSE-Z4	1084.7443.02
External harmonic mixers (for R&S®FSU26, R&S®FSU46 with option R&S®FSU-B21)		
Harmonic Mixer 40 GHz to 60 GHz	R&S®FS-Z60	1089.0799.02
Harmonic Mixer 50 GHz to 75 GHz	R&S®FS-Z75	1089.0847.02
Harmonic Mixer 60 GHz to 90 GHz	R&S®FS-Z90	1089.0899.02
Harmonic Mixer 90 GHz to 110 GHz	R&S®FS-Z110	1089.0976.02
For R&S®FSU26 only:		
Test port adapter N male		1021.0541.00
Test port adapter 3.5 mm male		1021.0529.00
Microwave Measurement Cable with test port adapter set N male and 3.5 mm male	R&S®FSE-Z15	1046.2002.02
For R&S®FSU46 only:		
Test port adapter N male		1036.4783.00
Test port adapter K male		1036.4802.00
Test port adapter 2.4 mm male	R&S®FSE-Z5	1088.1627.02



Contents Overview

Chapter Overview

Type Index

R&amp;S Addresses



## Signal Analyzers R&amp;S®FSQ

**R&S®FSQ3: 20 Hz to 3.6 GHz**

**R&S®FSQ8: 20 Hz to 8 GHz**

**R&S®FSQ26: 20 Hz to 26 GHz**

**Signal analysis with the dynamic range of a high-end spectrum analyzer and a demodulation bandwidth up to 120 MHz**

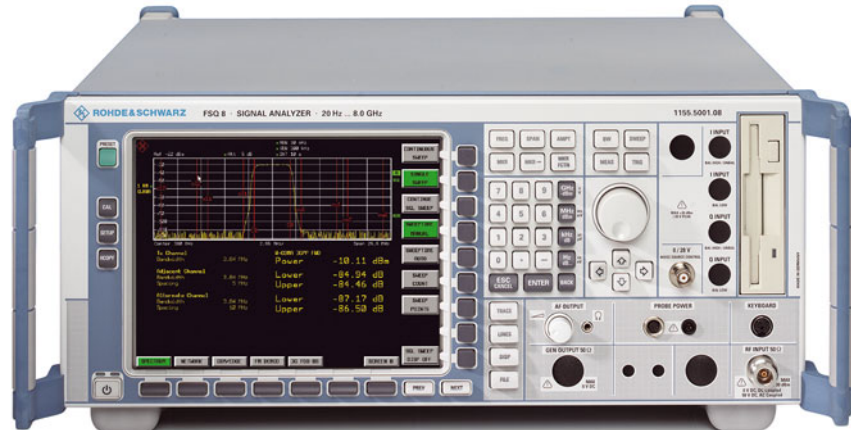

*Signal Analyzer R&S®FSQ8*

### Brief description

Future transmission methods in mobile radio and related fields call for wider transmission bandwidths to handle increasing data throughput. Even today, multiple carriers of a GSM or 3GPP base station are often boosted in common power output stages. This reduces the technical effort and costs on the one hand, but increases the bandwidth to be transmitted on the other. In both cases, analysis bandwidths exceeding those provided by present-day spectrum analyzers are required in development and production, while at the same time the dynamic range must satisfy stringent requirements.

The R&S®FSQ combines the outstanding spectrum analyzer features and functions of the R&S®FSU with a demodulation and analysis bandwidth that has been enhanced to 28 MHz. The R&S®FSQ is thus ideal for applications in the development and production of the following:

- ◆ Wireless LAN (WLAN)
- ◆ 3GPP and GSM-MCPA

The R&S®FSQ additionally supports measurements on 2G, 2.5G and 3G mobile

radio systems when using application firmware such as:

- ◆ R&S®FS-K5, GSM/EDGE
- ◆ R&S®FS-K72/K74, 3GPP FDD BTS
- ◆ R&S®FS-K73, 3GPP FDD UE
- ◆ R&S®FS-K82/K84, FS-K83/K85, cdma2000

The option Vector Analysis R&S®FSQ-K70 extends the R&S®FSQ to an universal signal analyzer for digital modulated signals.

In addition to the broadband demodulation capabilities, the R&S®FSQ provides the dynamic range that is required for multicarrier measurements or the measurement of spurious emissions at base transceiver stations (BTS).

### Main features

- ◆ Dynamic range of a high-end spectrum analyzer
  - TOI typ. +25 dBm
  - 1 dB compression +13 dBm
  - 84 dB ACLR/3GPP with noise correction
- ◆ Displayed average noise level –158 dBm (1 Hz bandwidth)
- ◆ Phase noise –160 dBc (1 Hz) at 10 MHz carrier offset

- ◆ 28 MHz I/Q demodulation bandwidth
- ◆ 16 Msample I and Q memory
- ◆ Statistical signal analysis with CCDF function
- ◆ Software for measurements on 802.11a wireless LAN
- ◆ I/Q data extraction, e.g. for MCPA adjustment
- ◆ Code domain power measurement for 3GPP WCDMA optional
- ◆ Versatile resolution filters: Gaussian, FFT, channel, RRC
- ◆ RMS detector (100 dB dynamic range)
- ◆ Transducer factor for correcting antenna or cable frequency responses
- ◆ Full choice of detectors
  - RMS, SAMPLE, AVERAGE
  - AUTO/MAX/PEAK
  - QUASI PEAK (QPK)

### Characteristics

#### Signal analyzer

The R&S®FSQ features a digital back end that benefits from the progress in ADC and ASIC development. Time-consuming evaluation algorithms are implemented directly in hardware – a prerequisite for fast measurement and high accuracy.

- ◆ 14-bit A/D converter 81.6 MHz
- ◆ Digital hardware resampler to match the sampling rate to the signal



## Signal Analyzers R&S®FSQ

- ◆ Sampling rate from 10 kHz to 81.6 MHz adaptable to the modulation rate
- ◆ SFDR >80 dBfs
- ◆ Digital downconversion to baseband with high output bandwidth (28 MHz referred to RF)

### Most versatile resolution filter characteristics and largest bandwidth

- ◆ Standard resolution filters from 10 Hz to 50 MHz in steps of 1, 2, 3, 5
- ◆ FFT filters from 1 Hz to 30 kHz
- ◆ 32 channel filters with bandwidths from 100 Hz to 5 MHz
- ◆ RRC filters for NADC, TETRA and 3GPP
- ◆ EMI filters 200 Hz, 9 kHz, 120 kHz

### Full range of analysis functions

- ◆ Time domain power in conjunction with channel or RRC filters make the R&S®FSQ a full-fledged channel power meter
- ◆ TOI marker, noise/phase noise marker
- ◆ Versatile channel/adjacent-channel power measurement functions with wide selection of standards; user-configurable
- ◆ Split-screen mode with selectable settings
- ◆ CCDF measurement function
- ◆ Peak list marker for fast search of all peaks within the set frequency range (search for spurious)

*Measurement of adjacent-channel power on a 3GPP four-carrier signal with noise correction*

### High measurement speed

- ◆ 2.5 ms sweep time in frequency domain
- ◆ 1 μs sweep time in time domain
- ◆ Number of measurement points/trace selectable between 155 and 10001
- ◆ Time-selective spectrum analysis with gating function
- ◆ Up to 20 measurements/s (man. mode)
- ◆ Up to 30 measurements/s (GPIB mode)
- ◆ Fast ACP measurement in time domain

### Flexible data interchangeability

- ◆ LAN interface (10/100 BaseT)
- ◆ Network capable workstation by Embedded Windows XP
- ◆ All elements of the R&S®FSQ screen are represented by a soft front panel function; the complete R&S®FSQ screen shows on the remote PC
- ◆ Special RSIB interface (Windows and UNIX) links the user's application to the TCP/IP protocol and acts like an IEC/IEEE-bus driver

- ◆ GPIB interface, IEEE488.2
  - SCPI-compatible GPIB command set
  - R&S®FSE/R&S®FSIQ-compatible GPIB command set
- ◆ RS-232-C, VGA output
- ◆ USB interface for firmware updates, PC peripherals and data exchange by memory sticks
- ◆ Integrated standard disk drive

### Options

#### Up to 120 MHz demodulation bandwidth (option R&S®FSQ-B72)

This option extends the demodulation bandwidth to 60 MHz (f <3.6 GHz) respectively up to 120 MHz (f >3.6 GHz). This is useful for I/Q data extraction for MCPA characterization. Using the option Vector Signal Analyzer R&S®FSQ-K70 the option R&S®FSQ-B72 extends the max. symbol rate from 25 MSymbol/s to 81.6 MSymbol/s.

#### WLAN measurements

Following application firmware enable measurements on WLAN signals:

- ◆ R&S®FSQ-K90 for measurements on 802.11a and 802.11g OFDM signals
- ◆ R&S®FSQ-K91 for measurements according to 802.11a, b, g and 802.11j standards

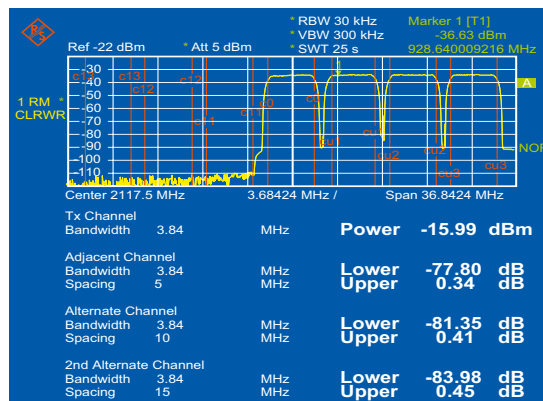

## Specifications in brief

You will find detailed and binding data on the enclosed CD (./DATASHEET/FSQ.pdf), or, for the latest updates, visit [www.rohde-schwarz.com](http://www.rohde-schwarz.com), search term: FSQ

	R&S®FSQ3	R&S®FSQ8	R&S®FSQ26
Frequency range			
DC coupled	20 Hz to 3.6 GHz	20 Hz to 8 GHz	20 Hz to 26.5 GHz
AC coupled	1 MHz to 3.6 GHz	1 MHz to 8 GHz	10 MHz to 26.5 GHz
Frequency resolution	0.01 Hz		
Frequency display	with marker or frequency counter		
Marker resolution	0.1 Hz to 10 kHz (dependent on span)		
Frequency counter resolution	0.1 Hz to 10 kHz (selectable)		
Frequency span	0 Hz, 10 Hz to 3.6 GHz	0 Hz, 10 Hz to 8 GHz	0 Hz, 10 Hz to 26.5 GHz



Contents Overview

Chapter Overview

Type Index

R&S Addresses



## Signal Analyzers R&S®FSQ

Spectral purity (dBc (1 Hz)), SSB phase noise, f = 640 MHz	
Carrier offset	
1 kHz	<-112 dBc (1 Hz), typ. -116 dBc (1 Hz)
100 kHz	<-120 dBc (1 Hz), typ. -123 dBc (1 Hz)
10 MHz	<-155 dBc (1 Hz), typ. -160 dBc (1 Hz)
<b>Sweep</b>	
Span 0 Hz	1 μs to 16000 s in steps of 5%
Span ≥10 Hz	2.5 ms to 16000 s in steps ≤10%
<b>Resolution bandwidth</b>	
3 dB bandwidths	10 Hz to 20 MHz in 1/2/3/5 sequences, 50 MHz
<b>Video bandwidths</b>	
	1 Hz to 10 MHz in 1/2/3/5 sequences
<b>Filters</b>	
FFT (3 dB bandwidths)	1 Hz to 30 kHz in 1/2/3/5 sequence
EMI (6 dB bandwidths)	200 Hz, 9 kHz, 120 kHz
<b>Channel</b>	
Bandwidths	100/200/300/500 Hz, 1/1.5/2/2.4/2.7/3/3.4/4/4.5/5/6/8.5/9/10/12.5/14/15/ 16/18 (RRC)/20/21/24.3 (RRC)/25/30/50/100/150/ 192/200/300/500 kHz, 1/1.228/1.5/2/3/5 MHz
<b>Level</b>	<b>R&amp;S®FSQ3</b> <b>R&amp;S®FSQ8</b> <b>R&amp;S®FSQ26</b>
1 dB compression of input mixer (0 dB RF attenuation, nominal values)	+13 dBm    +13 dBm up to 3.6 GHz -    +10 dBm    +7 dBm 3.6 GHz to 8 GHz    3.6 GHz to 26 GHz
<b>Intermodulation</b>	
Third-order intermodulation (third-order intercept (TOI), level 2 × -10 dBm, Δf >5 × RBW or 10 kHz, whichever is the greater value), for f =	
10 MHz to 300 MHz	typ. +20 dBm    typ. +20 dBm    typ. +20 dBm
300 MHz to 3.6 GHz	typ. +25 dBm    typ. +25 dBm    typ. +27 dBm
3.6 GHz to 8 GHz	-    typ. +23 dBm    -
3.6 GHz to 26.5 GHz	-    -    typ. +15 dBm
Second harmonic intercept point (SHI)	
1 GHz < f <sub>in</sub> ≤ 1.8 GHz	>35 dBm
f <sub>in</sub> > 1.8 GHz	-    >80 dBm
<b>Maximum dynamic range</b>	
1 dB compression to DANL (1 Hz)	170 dB
<b>Displayed average noise level</b>	
(0 dB RF attenuation, RBW 10 Hz, VBW 30 Hz, 20 averages, trace average, span 0 Hz, termination 50 Ω, typical values)	
10 MHz ≤ f < 2 GHz	-148 dBm    -148 dBm    -146 dBm
2 GHz ≤ f ≤ 3 GHz	-147 dBm    -147 dBm    -
2 GHz ≤ f < 3.6 GHz	-    -    -143 dBm
3 GHz ≤ f ≤ 3.6 GHz	-147 dBm    -146 dBm    -
3.6 GHz ≤ f < 7 GHz	-    -142 dBm    -
3.6 GHz ≤ f < 8 GHz	-    -    -145 dBm
7 GHz ≤ f < 8 GHz	-    <-142 dBm    -
8 GHz ≤ f < 13 GHz	-    -    -143 dBm
13 GHz ≤ f < 18 GHz	-    -    -141 dBm
18 GHz ≤ f < 22 GHz	-    -    -138 dBm
22 GHz ≤ f < 26.5 GHz	-    -    -136 dBm
<b>Immunity to interference (f ≤ 3.6 GHz)</b>	
Image frequency	>90 dB, >110 dB typ.
Intermediate frequency	>90 dB, >110 dB typ.
Spurious responses (f >1 MHz, without input signal, 0 dB attenuation)	<-103 dBm
<b>Level display (spectrum mode)</b>	
Screen	625 × 500 pixels (one diagram), max. 2 diagrams with independent settings
Logarithmic level axis	1 dB, 10 dB to 200 dB in steps of 10 dB
Linear level axis	10% of reference level per level division, 10 divisions or logarithmic scaling

	R&S®FSQ3	R&S®FSQ8	R&S®FSQ26
Traces	max. 6, with two diagrams on screen, max. 3 per diagram		
Trace detector	Max Peak, Min Peak, Auto Peak (normal), Sample, RMS, Average, Quasi Peak		
Number of trace measurement points	625 (default value), 155 to 10001 in steps of about a factor of 2		
Trace functions	Clear/Write, Max Hold, Min Hold, Average		
<b>Setting range of reference level</b>			
Logarithmic level display	-130 dBm to (+5 dBm + RF attenuation), max. 30 dBm, in steps of 0.1 dB		
Linear level display	7.0 nV to 7.07 V in steps of 1%		
<b>Frequency response (DC coupling, RF attenuation ≥10 dB, +20°C to +30°C)</b>			
10 MHz to 3.6 GHz	<0.3 dB (σ = 0.1 dB)		
Span <1 GHz			
3.6 GHz ≤ f < 8 GHz	<1.5 dB (σ = 0.5 dB)		
8 GHz to ≤ f < 22 GHz	-	-	<2 dB (σ = 0.7 dB)
22 GHz ≤ f < 26.5 GHz	<2.5 dB (σ = 0.8 dB)		
f ≥3.6 GHz, span ≥1 GHz	add 0.5 dB to above values		
Attenuator (≥5 dB)	<0.2 dB		
<b>Display nonlinearity (+20°C to +30°C, mixer level = -10 dBm)</b>			
Logarithmic level display, RBW = 100 kHz or channel filters,			
S/N >20 dB, 0 dB to -70 dB	<0.1 dB (s = 0.03 dB)		
200 kHz = RBW = 10 MHz, S/N >16 dB			
0 dB to -50 dB	<0.2 dB (s = 0.07 dB)		
RBW >10 MHz, S/N >16 dB			
0 dB to -50 dB	<0.5 dB (s = 0.17 dB)		
Linear level display	5% of reference level		
<b>Bandwidth switching error referenced to RBW = 10 kHz</b>			
1 Hz to 100 kHz	<0.1 dB (s = 0.03 dB)		
200 kHz to 3 MHz	<0.2 dB (s = 0.07 dB)		
5 MHz to 50 MHz	<0.5 dB (s = 0.15 dB)		
FFT filter 1 Hz to 3 kHz	<0.2 dB (s = 0.07 dB)		
<b>Total measurement error</b>			
(0 dB to -70 dB, S/N >20 dB, span/RBW <100, 95% confidence level) (20°C to 30°C, mixer level ≤-10 dBm)			
f < 3.6 GHz	0.3 dB (RBW ≤100 kHz) 0.5 dB (RBW >100 kHz)		
3.6 GHz ≤ f < 8 GHz	2.0 dB		
8 GHz ≤ f < 18 GHz	2.5 dB		
18 GHz ≤ f < 26.5 GHz	3.0 dB		
<b>I/Q data</b>			
Sampling rate	programmable: 10 kHz to 81.6 MHz in 0.1 Hz steps		
ADC resolution	14 bit		
I/Q memory	16 Msample each for I and Q data		
Max. information bandwidth	28 MHz		
<b>Interfaces</b>			
Remote control	IEC625-2 (IEEE 488.2)		
Serial	RS-232-C (COM), 9-pin Sub-D female		
Printer	parallel (Centronics-compatible)		

### General data

	R&S®FSQ3	R&S®FSQ8	R&S®FSQ26
Display	21 cm TFT LCD colour display (8.4", SVGA)		
Rated temperature range	+5°C to +40°C		
AC power supply	100 V AC to 240 V AC, 3.1 A to 1.3 A, 50 to 400 Hz		
Power consumption	typ. 130 VA	typ. 150 VA	
Dimensions (W x H x D)	435 mm × 192 mm × 460 mm		
Weight	14.6 kg	15.4 kg	15.6 kg



Contents Overview

Chapter Overview

Type Index

R&S Addresses





Contents Overview

Chapter Overview

Type Index

R&S Addresses



## Signal Analyzers R&S®FSQ

### Optional Electronic Attenuator R&S®FSU-B25

Electronic attenuator	0 dB to 30 dB, 5 dB steps
Preamplifier	20 dB, switchable
Frequency response, with preamplifier or electronic attenuator	
10 MHz to 50 MHz	<1.0 dB
50 MHz to 3.6 GHz	<0.6 dB
3.6 GHz to 8 GHz	<2.0 dB
Displayed average noise level (RBW = 1 kHz, VBW = 3 kHz, zero span, sweep time 50 ms, 20 averages, mean marker, normalized to 10 Hz RBW, preamplifier on)	
10 MHz to 2 GHz	<-152 dBm
2.0 GHz to 3.6 GHz	<-150 dBm
3.6 GHz to 8.0 GHz	<-147 dBm
Intermodulation (third-order intermodulation, third-order intercept (TOI), electronic attenuator on, $\Delta f > 5 \times$ RBW or 10 kHz)	
10 MHz to 300 MHz	>17 dBm
300 MHz to 3.6 GHz	>20 dBm
3.6 GHz to 8 GHz	>18 dBm

### I/Q Baseband Inputs R&S®FSQ-B71

Frequency range	DC to 36 MHz
Useful bandwidth with specified output data rate $f_s = 81.6$ MHz	
Input level range (full scale), unbalanced, balanced differential voltage	$\pm 31.6$ mV to $\pm 5.62$ V (50 $\Omega$ , 5 dB steps)
Frequency response, 50 $\Omega$ , $f_s = 81.6$ MHz, filter off	
DC to 36 MHz	<0.3 dB
I/Q imbalance, DC to 36 MHz	<0.15 dB
Noise level, signal-to-noise ratio, range = 1 V, signal level equal to range	typ. 143 dBc (1 Hz)
Connector, each channel balanced or unbalanced	4 $\times$ BNC female
unbalanced setting, common mode	50 $\Omega$ /1 k $\Omega$ nominal
balanced setting	
common mode	50 $\Omega$ /1 k $\Omega$ *) nominal
differential	100 $\Omega$ /1.5 k $\Omega$ nominal *) with other input shorted to ground

### I/Q Bandwidth Extension R&S®FSQ-B72

Useful bandwidth	
$\leq 3.6$ GHz	60 MHz
$> 3.6$ GHz, $f_s =$ output sampling rate	
81.6 MHz $< f_s < 163.2$ MHz	$0.68 \times f_s$
163.2 MHz $= f_s = 326.4$ MHz	120 MHz
Output sampling rate	
min.	$> 81.6$ MHz
max.	326.4 MHz
Signal-to-noise ratio	
Mixer level $= -20$ dBm signal level equal to reference level	128 dBc (1 Hz), typ. $> 125$ dBc (1 Hz)
Sampling rate	programmable, $> 81.6$ MHz to 326.4 MHz in 0.1-Hz steps
ADC resolution	8 bit

### Ordering information

Signal Analyzer		
20 Hz to 3.6 GHz	R&S®FSQ3	1155.5001.03
20 Hz to 8 GHz	R&S®FSQ8	1155.5001.08
20 Hz to 26.5 GHz	R&S®FSQ26	1155.5001.26

### Accessories supplied

Power cable, operating manual, service manual; R&S®FSQ26: test port adapter with 3.5 mm female (1021.0512.00) and N female (1021.0535.00) connector

### Options

External Generator Control	R&S®FSP-B10	1129.7246.02
Highly Accurate Reference Frequency	R&S®FSU-B4	1144.9000.02
Tracking Generator, 9 kHz to 3.6 GHz	R&S®FSU-B9	1142.8994.02
Output Attenuator, 0 dB to 70 dB, for R&S®FSU-B9	R&S®FSU-B12	1142.9349.02
LO/IF Connectors for External Mixers	R&S®FSU-B21	1157.1090.02
Preamplifier 20 dB, 3.6 GHz to 26.5 GHz (only factory fitted)	R&S®FSU-B23	1157.0907.02
Electronic Attenuator, 0 dB to 30 dB, with integrated 20 dB preamplifier	R&S®FSU-B25	1144.9298.02
Analog Baseband Inputs	R&S®FSQ-B71	1157.0113.02
I/Q Bandwidth Extension	R&S®FSQ-B72	1157.0336.02

### Software

Noise Measurement Software	R&S®FS-K3	1057.3028.02
Application Firmware for Noise Figure and Gain Measurements	R&S®FS-K30	1300.6508.02
Phase Noise Measurement Software	R&S®FS-K4	1108.0088.02
GSM/EDGE Application Firmware	R&S®FS-K5	1141.1496.02
FM Measurement Demodulator	R&S®FS-K7	1141.1796.02
3GPP BTS/Node B FDD Application Firmware	R&S®FS-K72	1154.7000.02
UE FDD Application Firmware	R&S®FS-K73	1154.7252.02
3GPP HSDPA BTS Application Firmware	R&S®FS-K74	1300.7156.02
W-LAN Application Software		on request
Bluetooth® Measurements	R&S®FS-K8	1157.2568.02
Power Sensor Measurements	R&S®FS-K9	1157.3006.02
CDMA2000 Base Station Test	R&S®FS-K82	1157.2316.02
CDMA2000/1xEV-DV Mobile Test	R&S®FS-K83	1157.2416.02
CDMA2000/1xEV-DO Base Station Test	R&S®FS-K84	1157.2851.02
CDMA2000 1xEV-DO Mobile Station Test	R&S®FS-K85	1300.6689.02
Application Firmware		
Vector Signal Analysis	R&S®FSQ-K70	1161.8038.02
WLAN 802.11a Applications Firmware	R&S®FSQ-K90	1157.3064.02
WLAN 802.11a/b/g/j Applications Firmware	R&S®FSQ-K91	1157.3129.02

### Extras

Headphones	—	0708.9010.00
US Keyboard with trackball	R&S®PSP-Z2	1091.4100.02
PS/2 Mouse	R&S®FSE-Z2	1084.7043.02
Colour Monitor, 17", 230 V	R&S®PMC3	1082.6004.04
IEC/IEEE-Bus Cable, 1 m	R&S®PCK	0292.2013.10
IEC/IEEE-Bus Cable, 2 m	R&S®PCK	0292.2013.20
19" Rack Adapter	R&S®ZZA-411	1096.3283.00
Adapter for mounting on telescopic rails (only with 19" Adapter R&S®ZZA-411)	R&S®ZZA-T45	1109.3774.00

### Matching Pads, 75 $\Omega$

L Section	R&S®RAM	0358.5414.02
Series Resistor, 25 $\Omega$	R&S®RAZ	0358.5714.02
SWR Bridge, 5 MHz to 3000 MHz	R&S®ZRB2	0373.9017.52
SWR Bridge, 40 kHz to 4 GHz	R&S®ZRC	1039.9492.52
High-Power Attenuators, 100 W,		
3/6/10/20/30 dB (xx=03/06/10/20/ 30)	R&S®RBU 100	1073.8820.xx
High-Power Attenuators, 50 W		
3/6/10/20/30 dB (xx=03/06/10/20/ 30)	R&S®RBU 50	1073.8895.xx
20 dB, 6 GHz	R&S®RDL 50	1035.1700.52



Contents Overview

Chapter Overview

Type Index

R&S Addresses



## Noise Figure Measurement Software R&S®FS-K3

**Provides the high-grade analyzers with features otherwise only offered by special noise measurement systems**

*Measurements on a GaAs preamplifier show an anomaly at 140 MHz, whose cause is easily traceable in the spectrum analyzer mode*

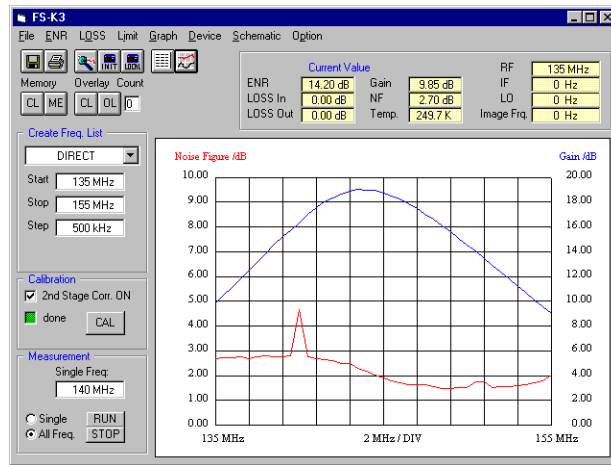

### Brief description

Spectrum Analyzers R&S®FSU and R&S®FSP as well as Signal Analyzers R&S®FSQ feature high sensitivity and level accuracy – in conjunction with switchable, calibrated noise sources – and are thus ideal for automatic measurement of noise figure and gain. Noise Figure Measurement Software R&S®FS-K3 provides the high-grade analyzers with features otherwise only offered by special noise measurement systems. At a given frequency or in a selectable frequency range the following parameters can be measured:

- ◆ Noise figure in dB
- ◆ Noise temperature in K
- ◆ Gain in dB
- ◆ Resolution bandwidths variable in steps of 1/2/3/5 (R&S®FSP: 1/3) for optimum matching to narrowband DUTs

The combination of Noise Figure Measurement Software R&S®FS-K3 and Analyzers R&S®FSU, R&S®FSQ or R&S®FSP offers the following advantages over conventional noise measurement systems:

- ◆ Frequency range up to 26.5 GHz (depending on analyzer model) for noise measurements in the microwave range without need for an additional downconverter

### Measurements on frequency-converting DUTs, e.g. low-noise converters

R&S®FS-K3 allows the noise figure and gain for instance of LNCs for direct satellite reception to be measured without any problems despite the great frequency difference of typ. 10 GHz between the input and output. A particular asset in these measurements is the extremely wide dynamic range, allowing the direct determination of gain values up to 60 dB.

### Specifications

<b>Frequency range</b>	100 kHz to 26.5 GHz (depending on analyzer model)
<b>Measurement bandwidth</b>	1 kHz to 5 MHz
<b>Noise measurements</b>	
Level range	0 to 25 dB
Resolution	0.01 dB
Measurement accuracy	±0.2 dB (preamplification 20 dB, noise figure 5 dB, bandwidth 1 MHz)
<b>Gain measurements</b>	
Level range	0 dB to 60 dB
Resolution	0.01 dB
Measurement accuracy (noise figure 5 dB, bandwidth 1 MHz)	±0.2 dB (preamplification 20 dB,

<b>Required hardware and software</b>	
Analyzers	R&S®FSU, R&S®FSQ, R&S®FSP
Recommended noise source	NoiseCom 346
Power supply	via 28 V connector on rear panel of R&S®FSU/FSQ/FSP (BNC)
Preamplifier	gain approx. 20 dB, noise figure max. 5 dB
<b>Control via external PC/IEC/IEEE bus</b>	
Software	Windows 9x/ME/NT/2000/XP
Interface	IEC 625-1 (IEEE 488)
Interface card	National Instruments AT/TNT/PC card
<b>Control via Spectrum Analyzer</b>	
R&S®FSP/FSU/FSQ	keyboard R&S®PSP-Z2

### Ordering information

<b>Noise Measurement Software</b>	R&S®FS-K3	1057.3028.02
-----------------------------------	-----------	--------------

## Application Firmware for Noise Figure and Gain Measurements R&S®FS-K30 for R&S®FSP/FSU/FSQ

### Outperforming any conventional noise measurement system

#### Brief description

The Spectrum Analyzers R&S®FSP and R&S®FSU as well as the Signal Analyzers R&S®FSQ feature high sensitivity and level accuracy – in conjunction with switchable, calibrated noise sources – are thus ideal for automatic measurement of noise figure and gain. Application Firmware R&S®FSK30 provides the high-grade analyzers with features otherwise only provided by special noise measurement systems. At a specified frequency or in a selectable frequency range the following parameters can be measured:

- ◆ Noise figure in dB
- ◆ Noise temperature in K
- ◆ Gain in dB

Compared to conventional noise measurement systems, R&S®FS-K30 used with the Analyzers R&S®FSP/FSU or R&S®FSQ has the advantage that a large variety of further RF measurements can also be performed. The measurement results are output as a graph or a list.

#### Specifications in brief

Frequency range	100 kHz to 26.5 GHz (depending on analyzer model)
Measurement bandwidth	
R&S®FSP; R&S®FSU/FSQ	1 kHz to 10 MHz; 1 kHz to 50 MHz
Noise measurements	
Level range; resolution	0 dB to 25 dB; 0.01 dB
Measurement accuracy	±0.2 dB (meas. with preamplifier (gain 20 dB, noise figure 5 dB) and 1 MHz bandwidth, valid for DUTs with noise figure 1 to 10 dB and gain > 10 dB)
Gain measurements	
Level range; resolution	0 dB to 60 dB; 0.01 dB
Measurement accuracy	±0.2 dB (preamplification 20 dB, noise figure 5 dB, bandwidth 1 MHz)



*Measurements on a GaAs preamplifier show an anomaly at 140 MHz, whose cause is easily traceable in the spectrum analyzer mode*



Up to four measurements can be represented in a diagram. All functions can be remote-controlled.

#### Easy to operate

The firmware runs on the R&S®FSP/FSU and R&S®FSQ analyzers that operate under Windows XP. The measurement results can be further processed, e.g. for documentation or presentation, using Windows standard software. A practi-

cally unlimited number of complete measurement routines can be stored. They facilitate reproducible and error-free measurements and include:

- ◆ Frequency range
- ◆ Noise source characteristics
- ◆ Type of DUT (amplifier, mixer, lownoise converter)
- ◆ Analyzer settings
- ◆ Measurement results

#### Required hardware and software

Analyzers	R&S®FSP/FSU/FSQ
Recomm. noise source	NoiseCom 346 (see data sheet R&S®FS-K30)
Power supply	via 28 V connector for R&S®FSP/FSU/FSQ (BNC)
Preamplifier	gain approx. 20 dB, noise figure max. 5 dB

#### Ordering information

<b>Application Firmware for Noise Figure and Gain Measurement for R&amp;S®FSP/FSU/FSQ</b>	R&S®FS-K30	1300.6508.02
<b>Options</b>		
External Generator Control	R&S®FSP-B10	1129.7246.02
Electronic Attenuator, 0 to 30 dB, 20 dB preamp.	R&S®FSU-B25	1144.9298.02
Electronic Attenuator, 0 dB to 30 dB, 5 dB steps, integrated preamplifier	R&S®FSP-B25	1129.7746.02
3.6 to 26.5 GHz RF preamplifier for R&S®FSU26 <sup>1)</sup>	R&S®FSU-B23	1157.0907.02
3.6 to 26.5 GHz RF preamplifier for R&S®FSQ26 <sup>1)</sup>	R&S®FSQ-B23	1157.0907.02

1) Factory installation only, not for retrofit and R&S®FSU-B25 required.

## Phase Noise Measurement Software R&S®FS-K4

Phase noise measurements with Spectrum Analyzers R&S®FSU, R&S®FSP, Signal Analyzers R&S®FSQ and EMI Test Receivers R&S®ESIB/ESPI

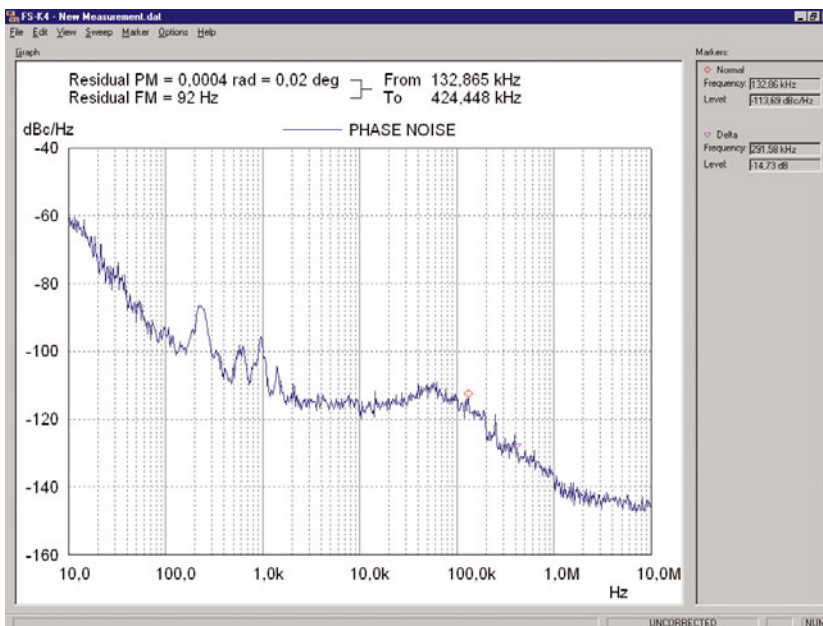

### Brief description

The Phase Noise Measurement Software R&S®FS-K4 extends the measurement capabilities of Rohde&Schwarz Spectrum Analyzers and EMI Test Receivers to give a phase noise tester. The R&S®FSU and the R&S®FSP are ideal for this purpose because of their low inherent phase noise and noise figure.

### Main features

- ◆ User-editable sweep settings
- ◆ Fast residual FM/φM measurements
- ◆ Comprehensive marker functions
- ◆ Storage of results and settings
- ◆ Detailed screen printouts

### Specifications

<b>Averaging</b>					
RBW:VBW ratio in video averaging	1:10, 1:1, 10:1				
Trace averaging	implemented				
Smoothing window	1 to 199 points				
<b>Carrier offset frequency range/number of decades</b>					
The maximum number of decades that can be represented in a phase noise diagram is defined by the carrier offset frequency range					
	<b>R&amp;S® FSU3/7</b>	<b>FSU26 FSQ3/8, ESIB7 FSP3/7, ESPI3/7</b>	<b>FSU46 FSQ26, ESIB26/40 FSP13/30/40</b>		
Lower offset limit	3 Hz	10 Hz	10 Hz		
Upper offset limit	1 GHz	1 GHz	10 GHz		
Max. number of decades	9	8	9		
<b>Nominal measurement accuracy (RSS error, 95% confidence level)</b>					
Minimum phase noise level 95 dB below reference level, FFT deactivated, return loss of source >14 dB (VSWR <1.5: 1), signal-to-noise ratio ≥10 dB					
<b>Center frequency</b>	<b>≤3.5 GHz</b>	<b>≤7 GHz</b>	<b>≤18 GHz</b>	<b>≤26.5 GHz</b>	<b>≤40 GHz</b>
Offset ≤10 MHz	1.5 dB	1.6 dB	1.9 dB	1.9 dB	1.9 dB
Offset >10 MHz	1.8 dB	2 dB	2.9 dB	3.4 dB	3.9 dB

<b>Repeatability</b>		
95% confidence level, RBW:VBW 10:1, trace averaging <15, smoothing window ≥9	±0.8 dB	
<b>System phase noise</b>		
A systematic measurement uncertainty is introduced by the inherent phase noise of the measuring instrument.		
<b>System Requirements</b>		
Control via external PC/IEEE bus	Windows 9x/NT4.0/2000/XP (English version), IEEE 488 interface, AT/TNT/PCMCIA IEEE card	

### Ordering Information

<b>Phase Noise Measurement Software</b>	R&S®FS-K4	1108.0088.02
---	-----------	--------------

## AM/FM/PM Measurement Demodulator R&S®FS-K7

### AM/FM/PM Measurement

#### Demodulator for Spectrum Analyzer

#### R&S®FSP for determining analog modulation parameters

*Bluetooth modulation characteristics: The frequency deviation of the signal is determined for a specified bit sequence (...1111 0000...or 10101010...) and displayed as a measured trace and in numerical form*

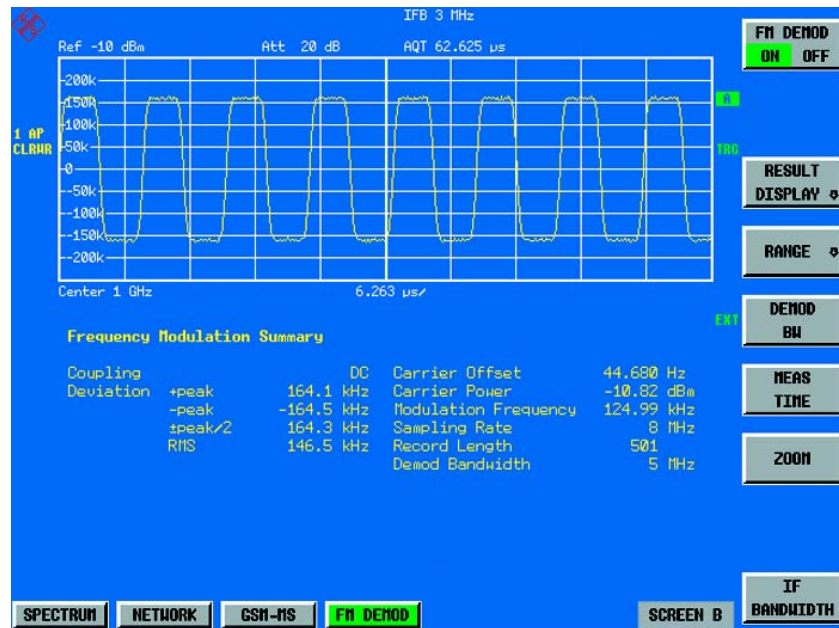

### Brief description

Option R&S®FS-K7 adds FM demodulation to the functions of Spectrum Analyzer R&S®FSP. The universal characteristics of the digital measurement demodulator open up a wide range of applications, e.g. measurements of synthesizer settling or frequency deviation. This makes R&S®FSP with option R&S®FS-K7 ideal for measuring modulation characteristics such as those required in the development and production of *Bluetooth*® modules.

### Main features

#### Display

- ◆ Frequency modulation (FM) or carrier power as a function of time
- ◆ RF spectrum (FFT)
- ◆ Table with numeric values for peak and RMS deviation, modulation frequency (AF), carrier offset, carrier power

### Features

- ◆ Digital measurement demodulator with wide bandwidth range from 12.5 kHz to 10 MHz
- ◆ Restoration of sampled signal with high measurement accuracy
- ◆ Ideal for production and development of *Bluetooth* modules
- ◆ Great memory depth for long measurement sequences (I/Q memory 2 x 128 ksamples)

### Measurements

The measurement results can be subsequently displayed as

- ◆ Frequency (FM) or carrier power versus time or as an
- ◆ RF spectrum (FFT)

The main modulation parameters such as frequency deviation (peak, RMS), modulation frequency or carrier power are also numerically indicated in a table.

The sampled signal is restored and the signal is displayed in its original form. The sampling rate is automatically matched to the demodulation bandwidth.

Sequences with a length of up to 8.3 s (demodulation bandwidth 12.5 kHz) or 65 ms (demodulation bandwidth 1.6 MHz) can be recorded in the large I/Q memory of the R&S®FSP. This allows long bit sequences, such as occur with *Bluetooth*® signals, to be completely investigated. The demodulated data can also be read out via GPIB, RS-232-C or LAN and processed on an external PC.

The FM and RF level trigger function with a wide dynamic range provides special trigger capabilities. This also allows signals to be tested for which no external trigger signal is available.

## AM/FM/PM Measurement Demodulator R&amp;S®FS-K7

*Transient response of synthesizer:  
With the FM measurement demodulator function, the transient response of a synthesizer can be measured in digital communication systems like GSM or Bluetooth transmitters*

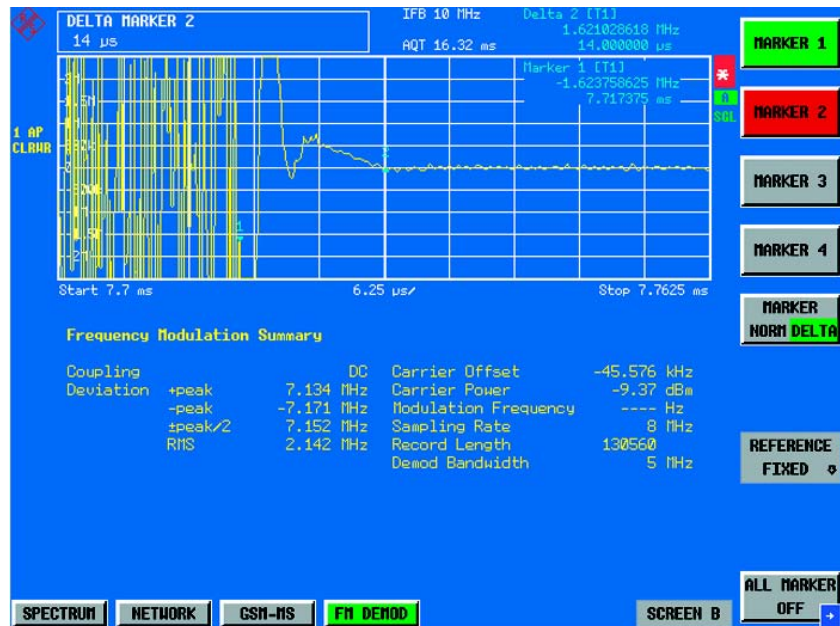

## Specifications

Measurement of analog modulation signals		Display nonlinearity	
Demodulation bandwidth	12.5 kHz to 10 MHz	S/N > 16 dB	typ. 0.2 dB
Max. record time		Incidental AM with FM (AF + deviation ≤ 0.5 × demodulation bandwidth and deviation ≤ 0.1 × IF bandwidth)	typ. 0.1 dB + residual AM
Demodulation bandwidth ≤ 1.6 MHz	≥ 85 s / (demodulation bandwidth / kHz)	<b>Unmodulated carrier power</b>	
Demodulation bandwidth > 1.6 MHz	≥ 34 s / (demodulation bandwidth / kHz)	Measurement uncertainty (S/N > 16 dB, RF = 50 kHz to 3 GHz)	typ. 1 dB
Readout	trace with frequency or RF power versus time, RF spectrum and table with numerical display of peak and rms values of deviation, modulation frequency, carrier offset, carrier power (power of unmodulated carrier)	<b>AF</b>	
<b>Frequency demodulation</b>		Range	≤ 5 MHz (max. 0.5 × demod. bandwidth)
AF	DC to 5 MHz (max. 0.5 × demodulation bandwidth)	Resolution	5 digits
Deviation range	5 MHz (max. 0.5 × demod. bandwidth)	Uncertainty	0.1%
Deviation uncertainty (AF + dev. ≤ 0.5 × demodulation bandwidth and AF ≤ 0.1 × IF bandwidth)	< 3% of result + residual FM	<b>RF spectrum</b>	
<b>Residual FM<sup>1)</sup></b>		Span	12.5 kHz to 10 MHz
Demodulation bandwidth ≤ 200 kHz, rms		Resolution bandwidth (FFT filters)	1 Hz to 10 MHz
RF ≤ 1 GHz	typ. 80 Hz	Shape factor 60:3 dB	2.5 nominal
RF > 1 GHz	typ. 80 Hz × √(f/1 GHz)	<b>Ordering information</b>	
<b>Carrier power versus time</b>		<b>Measurement Demodulator for R&amp;S®FSP</b>	R&S®FS-K7 1141.1796.02
AF	DC to 5 MHz (max. 0.5 × demodulation bandwidth)		
Display range	noise floor to +30 dBm		
Max. dynamic range			
Demod. bandwidth 200 kHz	typ. 75 dB		

<sup>1)</sup> RF input level ≥ (reference level / dBm - 10) dBm and RF input level ≥ (RF attenuation / dB - 30) dBm.



## Option Vector Signal Analyzer R&S®FSQ-K70



**Universal demodulation, analysis and documentation of digital radio signals**

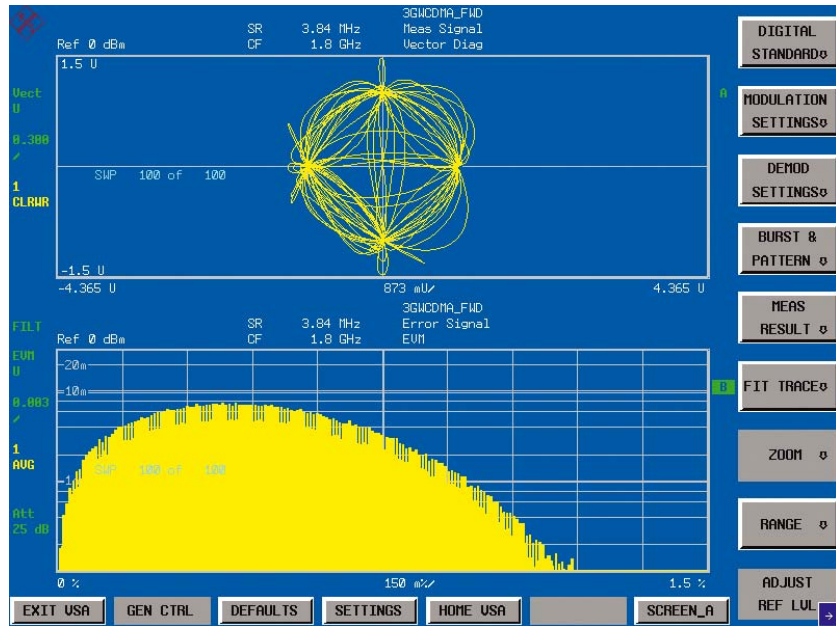

*The vector diagram enables convenient analysis of the degradation of modulation accuracy caused, for example, by nonlinearities, phase noise or amplitude-dependent phase response of amplifiers, converters, etc; the upper screen (A) shows the complete constellation diagram, the lower screen (B) the probability distribution of the error vector magnitude (EVM)*

### Brief description

#### Universal analysis of digital radio signals

The vector signal analyzer option upgrades the Signal Analyzers R&S®FSQ, adding universal demodulation and analysis capability down to bit stream level for digital radio signals. The option supports all common mobile radio communication standards.

#### Measurement and analysis of digital modulation signals

In addition to performing standard measurements such as determination of modulation accuracy, carrier leakage or I/Q imbalance, you can also study the information statistics of these parameters such as the standard deviation of carrier frequency error calculated over 10 measurements.

*AM/φM and AM/AM distortion example with a 16QAM signal (pictures bottom)*

*The right picture shows the constellation diagram where the outer constellation points are drawn to the center of the diagram as a result of the amplifier compression; the left picture shows the AM/AM and AM/φM conversion curve of the same signal*

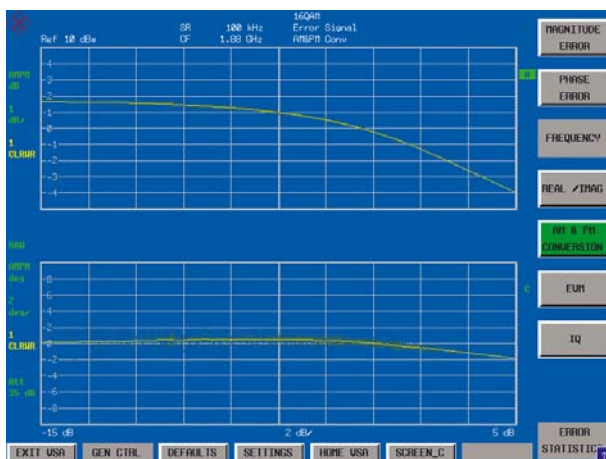

## Option Vector Signal Analyzer R&S®FSQ-K70

### Main features

#### For all major mobile radio communication standards

- ◆ GSM & EDGE
- ◆ WCDMA-QPSK
- ◆ CDMA2000-QPSK
- ◆ Bluetooth™
- ◆ TETRA
- ◆ PDC
- ◆ PHS
- ◆ DECT
- ◆ NADC

#### For all common digital modulation modes

- ◆ BPSK, QPSK, OQPSK,  $\pi/4$  DQPSK
- ◆ 8PSK, D8PSK,  $3\pi/8$  8PSK
- ◆ (G)MSK, 2, 4, (G)FSK
- ◆ 16, 32, 64, 128, 256 (D)QAM
- ◆ 20.4 MHz symbol rate
- ◆ 28 MHz I/Q demodulation bandwidth

#### Optimum representation of results

- ◆ In-phase and quadrature signals versus time
- ◆ Magnitude and phase versus time
- ◆ Eye, vector and constellation diagrams
- ◆ Table with modulation errors
- ◆ Demodulated bit stream
- ◆ Statistical evaluation of modulation parameters
- ◆ Amplifier distortion measurements

#### Characteristics

##### Multiple test functions in one unit

The Signal Analyzers R&S®FSQ in conjunction with the option R&S®FSQ-K70 replace several individual instruments:

- ◆ High-grade spectrum analyzer
- ◆ Vector demodulator
- ◆ Constellation analyzer

#### Any mobile radio standard at a key stroke

All major digital modulation standards can be activated at a key stroke. The instrument is then completely configured for measurements in line with the activated standard. The corresponding synchronization sequences are of course offered along with the standard.

#### Versatile in the lab

The R&S®FSQ with the option R&S®FSQ-K70 supports by providing user-selectable bit and symbol rates, filters, modulation schemes and synchronization sequences.

#### Efficient in production

The high measurement speed of 60 sweeps/s in the analyzer mode and typically 20 measurements/s using the vector signal analyzer function is ideal for applications in production.

### Specifications in brief

You will find detailed and binding data on the enclosed CD (./DATASHEET/FSQ-K70.pdf), or, for the latest updates, visit [www.rohde-schwarz.com](http://www.rohde-schwarz.com), search term: FSQ-K70

#### Modulation formats

FSK (including GFSK)	2 FSK, 4 FSK
MSK (including GMSK)	Yes
PSK (EDGE)	BPSK, QPSK, OQPSK, DQPSK, $\pi/4$ DQPSK, 8PSK, D8PSK, $3\pi/8$ 8PSK
QAM	
Absolute encoding	16QAM, 32QAM, 64QAM, 128QAM, 256QAM
Differential encoding	D16QAM, D32QAM, D64QAM, D128QAM, D256QAM

#### Predefined standards

Cellular	
3GPP WCDMA (QPSK)	Forward link, reverse link
CDMA2000 1x (QPSK, OQPSK)	Forward link, reverse link
EDGE	Normal burst
GSM	Access burst, frequ. correction burst, normal burst, synchronization burst
NADC	Forward link, reverse link
PDC	Downlink, uplink
PHS	Communication burst, control burst

Wireless networking	
Bluetooth™	DH1/DH3/DH5 packets
DECT	Fixed part burst
TETRA	Control burst downlink, Data burst downlink
Filtering	
Filter types	Raised cosine (RC), root raised cosine (RRC), cdma2000 compliant, Gaussian, EDGE, none
User-selectable (Alpha, B × T)	0.1 to 1
Symbol rate	
Maximum symbol rate	25 MHz
with option R&S®FSQ-B72 for FSQ	81.6 MHz
Maximum bandwidth	28 MHz

### Ordering information

Vector Signal Analyzer for R&S®FSQ	R&S®FSQ-K70	1161.8038.02
<b>Recommended extras and options</b>	See data sheet Signal Analyzer R&S®FSQ, PD 0757.7652	
I/Q Baseband Inputs	R&S®FSQ-B71	1157.0113.02
I/Q Bandwidth Extension	R&S®FSQ-B72	1157.0336.02



Contents Overview

Chapter Overview

Type Index

R&amp;S Addresses



## GSM/EDGE Application Firmware R&amp;S®FS-K5 for R&amp;S®FSP

## The solution for easy and fast GSM and EDGE measurements

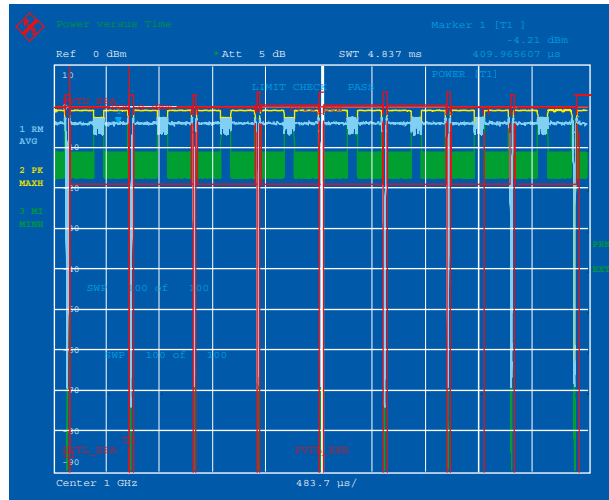

*Power-versus-time measurement: details of burst can be zoomed – rising edge, falling edge, high resolution display of top of burst*

### Brief description

The Application Firmware R&S®FS-K5 allows the user to perform the most important GSM and EDGE transmitter measurements with the push of a button:

- ◆ Phase/frequency error (GSM)
- ◆ Modulation accuracy (EDGE) including 95:th percentile and origin offset suppression
- ◆ Power-versus-time
- ◆ Carrier power
- ◆ Modulation spectrum
- ◆ Transient spectrum
- ◆ Spurious emissions

Only very few parameters have to be set manually such as carrier frequency, reference level, external attenuator. R&S®FS-K5 can be installed in all models of the R&S®FSP spectrum analyzer family:

- ◆ **R&S®FSP3:** 9 kHz to 3 GHz:  
Covers the basic TX frequency range
- ◆ **R&S®FSP7:** 9 kHz to 7 GHz: Adds harmonics measurement capability

- ◆ **R&S®FSP13:** 9 kHz to 13 GHz:  
Covers the entire spurious emissions frequency range
- ◆ **R&S®FSP30/40:** 9 kHz to 30/40 GHz:  
Adds microwave link frequency ranges

The application firmware can be used throughout the total frequency range of the basic spectrum analyzer. This covers all GSM bands of interest such as GSM900, GSM1800, GSM1900, R-GSM, GSM450 and even IF frequencies used in transmitters and receivers.

### Features and benefits

#### R&D, development

- ◆ Ideal development tool with easy-to-use GSM measurement functions in a cost-effective analyzer

#### Low measurement uncertainty for high confidence

- ◆ <0.5 dB total level uncertainty and <0.7° phase error for GSM

#### Standard-conformant measurements for performance verification

- ◆ Phase/frequency error (GSM), modulation accuracy (EDGE) and power-versus-time measurement with synchronization to midamble

#### Designed for speed

- ◆ Fast modulation spectrum routine for frequency list mode:  
±1.8 MHz/200 bursts in <25 seconds

#### Really portable – usable anywhere

- ◆ Lightweight, <11 kg with R&S®FSP3
- ◆ Comprehensive documentation and storage of results and hard copies on internal hard disk, print or transfer to a PC later – even via LAN /Ethernet

#### Trigger functions to meet many demands

- ◆ Simplified test setup, no trigger from device under test necessary
- ◆ IF power trigger for gated measurements



Contents Overview

Chapter Overview

Type Index

R&amp;S Addresses





## GSM/EDGE Application Firmware R&amp;S®FS-K5 for R&amp;S®FSP

## Specifications

- Specifications are ensured under the following conditions:
- 15 minutes warmup time at ambient temperature, specified environmental conditions met, calibration cycle adhered to, and total calibration performed.
- Data designated "nominal" apply to design parameters and are not tested.
- The specifications below apply to R&S®FSP3, R&S®FSP7, R&S®FSP13 and R&S®FSP30 equipped with R&S®FS-K5. They are based on the data sheet specifications of Spectrum Analyzers R&S®FSP and are not checked separately. Level measurement uncertainties given with a tolerance are measurement uncertainties with a confidence level of 95%. Data without tolerances are typical values at 900 MHz.
- The specified level measurement errors do not take into account systematic errors due to the reduced S/N ratio.

Measurement	Specification	Test specification, permissible measurement uncertainty acc. to I-ETS 300 609-1
<b>Phase/frequency error (GMSK modulation)</b>		11.10.1 13.1
Phase error, floor (S/N>40 dB)		
RMS	<0.7°	
Peak	<2°	
Phase error, uncertainty (S/N >40 dB)		
RMS	<0.2°	<1.5°
Peak	<0.7°	<5°
Frequency error uncertainty (S/N >40 dB)	<1.5 Hz + error of reference frequency	±10 Hz
<b>Modulation accuracy (3π/8 shifted 8PSK modulation)</b>		
EVM, residual (S/N >40 dB)		
RMS	<0.5%	
Peak	<1.5%	
95:th percentile	<1.5%	
Resolution	0.03%	
Frequency error uncertainty (S/N >40 dB)	<1 Hz + error of reference frequency	
Origin offset suppression (S/N >40 dB)		
Measurement range	–20 dBc to –50 dBc	
<b>Mean carrier power</b>		11.10.1 13.3
Absolute level uncertainty (–50 dBm to +30 dBm, 10 MHz to 3 GHz)	0.5 dB	1 dB
Relative level uncertainty (from 0 dB to –50 dB from reference level)	0.2 dB	0.7 dB
<b>Power versus time</b>		11.10.1 13.3
Uncertainty of reference	0.5 dB	1 dB
Relative uncertainty		0.7 dB
0 to –50 dB from reference	0.2 dB	
–50 to –70 dB from refer.	0.5 dB	
Internal symbol timing uncertainty	<37 ns	
Trigger reference uncertainty	¼ bit	¼ bit
Dynamic range (RBW = 600 kHz)	70 dB (with trace average) 60 dB (with peak hold)	

Measurement	Specification	Test specification, permissible measurement uncertainty acc. to I-ETS 300 609-1
<b>Spectrum due to modulation</b>		11.10.1 13.4
Level measurement uncertainty		
Absolute (–50 dBm to +30 dBm, 10 MHz to 3 GHz)	<0.5 dB	1 dB
Relative <sup>1)</sup>		
$\Delta f \leq 0.1$ MHz	<0.2 dB	0.5 dB
0.1 MHz < $\Delta f \leq 1.8$ MHz (0 dBc to –70 dBc)	<0.2 dB	0.7 dB
1.8 MHz < $\Delta f \leq 6$ MHz	<0.5 dB	1.5 dB
$\Delta f \geq 6$ MHz	<0.5 dB	2 dB
<b>Dynamic range (carrier power = 30 dBm)</b>		
Frequency offset		
200 kHz	65 dB	
400 kHz	67 dB	
600 kHz	68 dB	
1200 kHz	72 dB	
1800 kHz	76 dB	
1.8 MHz to 6 MHz (RBW = 100 kHz)	76 dB to 84 dB	
>6 MHz (RBW = 100 kHz)	84 dB	
<b>Spectrum due to transients</b>		11.10.1 13.4
Level measurement uncertainty		
Absolute (–50 dBm to +30 dBm, 10 MHz to 3 GHz)	<0.5 dB	1.5 dB
Relative		
0 dB to 50 dB from reference level	<0.2 dB	0.7 dB
>50 dB from reference level	<0.5 dB	1.5 dB
<b>Dynamic range with 30 dBm mean carrier power</b>		
Frequency offset		
400 kHz	62 dB	
600 kHz	64 dB	
1200 kHz	68 dB	
1800 kHz	71 dB	

<sup>1)</sup> Does not include the level uncertainty due to R&S®FSP inherent noise.

## Ordering information

GSM Mobile Station Test Application  
Firmware for Spectrum Analyzer  
R&S®FSP

R&amp;S®FS-K5

1141.1496.02



## WCDMA 3GPP Application Firmware R&S®FS-K72/-K73

**3GPP transmitter measurements on base stations and modules with Signal Analyzer R&S®FSQ and Spectrum Analyzers R&S®FSU and R&S®FSP**

*Peak code domain error measurement: The peak code domain error is projected to the codes of the highest spreading factors; the maximum value of all codes per slot is displayed*



### Brief description

Application Firmware R&S®FS-K72/-K73 can be installed on all models of the Signal Analyzer R&S®FSQ and Spectrum Analyzers R&S®FSU and R&S®FSP, and enhances the range of applications to include code domain power and modulation measurements on 3GPP FDD signals.

Featuring wide dynamic range for adjacent channel power, the R&S®FSU and the R&S®FSQ are ideal tools for WCDMA base station transmitter measurements in development and production. The R&S®FSP is the ideal development tool with easy-to-use measurement functions integrated into a cost-effective analyzer, especially in mobile radio development.

### Main features

- ◆ Adds measurement functions to the R&S®FSU, R&S®FSQ and R&S®FSP analyzer families in line with the 3GPP specifications for the FDD mode
- ◆ Application Firmware R&S®FS-K72 provides the functionality needed for base station testing. Application Firmware R&S®FS-K73 provides user equipment (UE) functionality:

Measurement	R&S®FSU R&S®FSP	R&S®FSU/ FSP with R&S®FS-K72	R&S®FSU/ FSP with R&S®FS-K73
Maximum output power	x		
CPICH power accuracy		x	N/A
Frequency error		x	x <sup>1)</sup>
Power control dynamic range		x	
Total power dynamic range		x	N/A
Occupied bandwidth	x		
Spectrum emission mask	x	x	x
ACLR	x		
Spurious emissions	x		
Error vector magnitude		x	x
Peak code domain error		x	x

<sup>1)</sup> Frequency relative to frequency received from BS.

### Configuration overview

	Base station		User equipment (UE)	
	R&S®FSQ/ R&S®FSU	R&S®FSP	R&S®FSQ/ R&S®FSU	R&S®FSP
R&S®FS-K72	●	●		
R&S®FS-K73			●	●
R&S®FSP-B15		●		●
R&S®FSP-B70		●		○ <sup>1)</sup>

<sup>1)</sup> Extends measurement range from one slot to one frame.



Contents Overview

Chapter Overview

Type Index

R&amp;S Addresses



## WCDMA 3GPP Application Firmware R&amp;S®FS-K72

- Code domain power (code domain analyzer)
- Code domain power versus time
- Error vector magnitude (EVM)
- Peak code domain error
- Timing offset

## Code domain power measurements

The main application of R&S®FS-K72/-K73 is the determination of the power in the individual code channels referred to as code domain power measurement. The power ratios between the individual channels, for instance, can be checked for compliance with the nominal values. Moreover, this measurement is a very efficient tool for detecting impairments

such as clipping or intermodulation that are not obvious from the spectrum alone. The power of the different codes is shown versus the code number. To investigate power control, the power characteristic in a code channel can be displayed versus all slots of a frame (10 ms).

The R&S®FSP requires the option R&S®FSP-B70 to perform measurements over more than one slot in the code domain.

## Specifications in brief

You will find detailed and binding data on the enclosed CD (./DATASHEET/FS-K7x.pdf), or, for the latest updates, visit [www.rohde-schwarz.com](http://www.rohde-schwarz.com), search term: FS-K72

Measurement	R&S®FSP	R&S®FSQ/ R&S®FSU
<b>Code domain power (applies to code domain power and code domain power vs slot)</b>		
Measurement uncertainty		
R&S®FS-K72: Total signal power		
R&S®FS-K73: Maximum output power	<0.5 dB	<0.3 dB
R&S®FS-K72: CPICH power		
R&S®FS-K73: Minimum output power	<0.5 dB	<0.4 dB
Absolute code power	<0.6 dB	<0.4 dB
Relative code power	<0.1 dB	<0.1 dB
<b>Frequency error</b>		
Measurement range	<1 kHz	<1 kHz
Measurement uncertainty (S/N >40 dB) + error of reference frequency	<1.5 Hz	<1.5 Hz
<b>Composite EVM</b>		
Measurement range	2% to 25%	1.5% to 25%
Inherent EVM	<2%	<1.5%
Measurement uncertainty	<1%	<0.5%
<b>Peak code domain error</b>		
Measurement range	0 dB to –55 dB	0 dB to –60 dB
Inherent PCDE	–55 dB	–60 dB
Measurement uncertainty	<1 dB (0 dB to 40 dB)	<1 dB (0 dB to 40 dB)
<b>Output power</b>		
Measurement uncertainty		
Absolute	<0.5	<0.3 dB
Relative	<0.2	<0.1 dB
<b>Occupied bandwidth (99%)</b>		
Measurement uncertainty	<85 kHz	<85 kHz

## ACLR (adjacent-channel leakage ratio, 3.84 MHz BW, 5 MHz offset only R&amp;S®FS-K73: test model .1 with 32 DPCH)

Dynamic range (without noise correction)	65 dB	77 dB
Measurement uncertainty	<0.3 dB + error due to S/N	<0.2 dB + error due to S/N
<b>Spurious emissions</b>		
Level uncertainty <3.6 GHz	<0.5 dB	<0.5 dB
Level uncertainty 3.6 GHz to 13 GHz	<2.5 dB	<2.5 dB
Spectrum emission mask	<1.5 dB	<1 dB

## Ordering information

## R&amp;S®FS-K72

Application Firmware R&S®FS-K72 can be integrated into any member of the R&S®FSU and R&S®FSQ family. Options R&S®FSP-B70 and option R&S®FSP-B15 are prerequisites for operating the application firmware on any member of the R&S®FSP spectrum analyzer family.

WCDMA 3GPP Application Firmware	R&S®FS-K72	1154.7000.02
3GPP HSDPA BTS Application Firmware (R&S®FS-K72 required)	R&S®FS-K74	1300.7156.02
Pulse Calibrator for R&S®FSP	R&S®FSP-B15	1155.1006.02
Demodulator Hardware for R&S®FSP	R&S®FSP-B70	1157.0559.02

## R&amp;S®FS-K73

Application Firmware R&S®FS-K73 can be integrated into any member of the R&S®FSQ & R&S®FSU families. Option R&S®FSP-B15 is a prerequisite for operating the application firmware on any member of the R&S®FSP spectrum analyzer family.

WCDMA 3GPP Application Firmware	R&S®FS-K73	1154.7252.02
Pulse Calibrator for R&S®FSP	R&S®FSP-B15	1155.1006.02

## Recommended extras

R&S®FSP-B70 extends the measurement range of the Application Firmware R&S®FS-K73 for the Spectrum Analyzer R&S®FSP from one slot to one frame.

Demodulator Hardware for R&S®FSP	R&S®FSP-B70	1157.0559.02
----------------------------------	-------------	--------------



Contents Overview

Chapter Overview

Type Index

R&amp;S Addresses





Contents Overview

Chapter Overview

Type Index

R&S Addresses



## TD-SCDMA Test Application Firmware R&S®FS-K76/-K77



### Base station and mobile station

tests on TD-SCDMA with the

R&S®FSQ, R&S®FSU and R&S®FSP

#### Code domain power measurement on a signal with 4 active channels (1)

Active and inactive channels are displayed; inactive channels (noise, interference) are displayed with a spreading factor of 16

The table also shows the main parameters of the total signal at a glance, e.g. total power, pilot power, frequency error and error of chip rate, as well as the parameters of the marked code channel such as code power and EVM

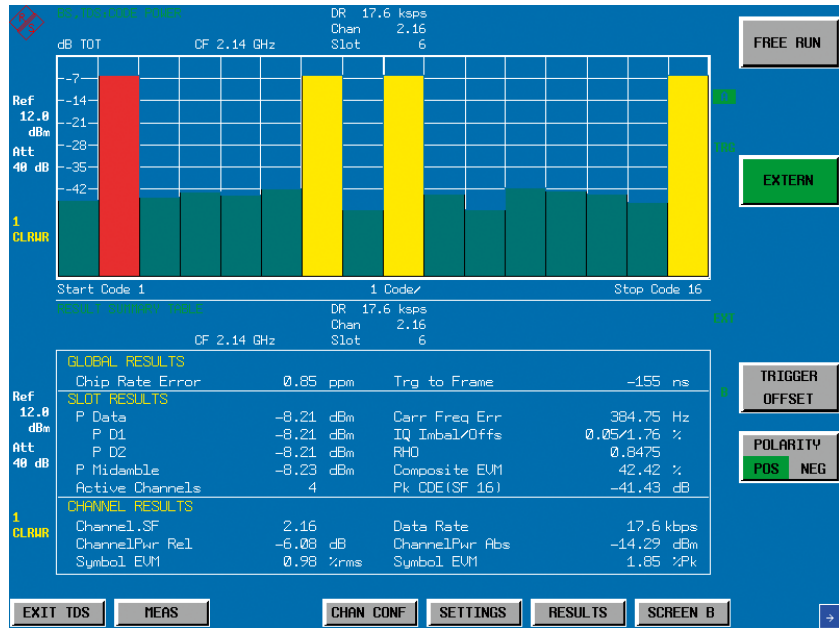

### Brief description

Application Firmwares R&S®FS-K76 and R&S®FS-K77 can be installed on any analyzer of the R&S®FSQ/FSU/FSP series.

R&S®FS-K76 enhances the range of applications with code domain power and modulation measurements on TD-SCDMA base stations. R&S®FS-K77 provides user equipment (UE) functionality.

Featuring a wide dynamic range for adjacent channel power, the R&S®FSQ and the R&S®FSU are ideal tools for base station transmitter measurements in development. The R&S®FSP is the ideal partner in development and production, featuring low uncertainty in level measurement, high measurement speed and excellent RF characteristics.

### Main features

- ◆ Adds measurement functions in line with 3GPP as well as China Wireless Telecommunication Standard Group (CWTS) specifications to the R&S®FSQ/FSU/FSP analyzer families
- ◆ R&S®FS-K76 provides the functionality needed for base station testing
- ◆ R&S®FS-K77 provides user equipment functionality

### Characteristics

#### TD-SCDMA

Two variants of the TD-SCDMA standard are available. One is the low chip rate (LCR) option of the TDD mode in 3GPP. The second is standardized by the China Wireless Telecommunication (CWTS) Standard group and is also known as TSM. The main difference between these two variants is that they connect to differ-

Measurement	R&S®FSU/FSP/FSQ	R&S®FSU/FSP/FSQ with R&S®FS-K76	R&S®FSU/FSP/FSQ with R&S®FS-K77
Maximum output power	3	3	3
Frequency error	–	3	3
P-CCPCH power	–	3	N/A
Power control dynamic range	–	3	3
Total power dynamic range	–	3	3
Occupied bandwidth	3	3	3
Spectrum emission mask	–	3	3
ACLR	3	3	3
Spurious emissions	3		



Contents Overview

Chapter Overview

Type Index

R&S Addresses





Contents Overview

Chapter Overview

Type Index

R&amp;S Addresses



## TD-SCDMA Test Application Firmware R&S®FS-K76/-K77

ent core networks. R&S®FS-K76 and R&S®FS-K77 support both variants.

### Code domain power measurements

The main application is to determine the power in the individual code channels, referred to as code domain power measurement. The power ratios between the

individual channels, for instance, can be checked for compliance with the nominal values. Moreover, this measurement is a very efficient tool for detecting transmitter impairments such as clipping or intermodulation that are not obvious from the spectrum alone.

### Remote control

All measurements can be remote-controlled. The results and demodulated data bits can be transferred via the IEC/IEEE bus. This makes R&S®FS-K76 and R&S®FS-K77 ideal for use in production.

## Specifications

The specifications are based on the specifications of the R&S®FSU, R&S®FSQ and R&S®FSP analyzers and have not been checked separately.

The specifications apply under the following conditions: 15 minutes warm up time at ambient temperature, specified environmental conditions met, calibration cycle adhered to and internal calibration performed. Data with tolerances: measurement uncertainties with a confidence level of 95%. Data without tolerances: typical values. The specified level measurement uncertainties do not take into account systematic errors due to reduced S/N ratio.

Measurement	R&S®FSP	R&S®FSQ/FSU
<b>Code domain power</b>		
Measurement uncertainty		
Total signal power	<0.5 dB	<0.3 dB
Code power		
Absolute	<0.6 dB	<0.1 dB
Relative	<0.4 dB	<0.1 dB
<b>Frequency error</b>		
Measurement range	<4 kHz	<4 kHz
Uncertainty (S/N > 40 dB)	<1.5 Hz + error of reference frequency	<1.5 Hz + error of reference frequency
<b>Composite EVM</b>		
Measurement range	1.5% to 25%	1% to 25%
Inherent EVM	<1.5%	<1%
Measurement uncertainty	<0.5%	<0.25%
<b>Peak code domain error (PCDE)</b>		
Measurement range	0 dB to -50 dB	0 dB to -54 dB
Inherent PCDE	-44 dB	-54 dB
Measurement uncertainty	<1 dB (0 dB to -40 dB)	<1 dB (0 dB to -40 dB)

Measurement	R&S®FSP	R&S®FSQ/FSU
<b>Output power</b>		
Measurement uncertainty		
Absolute	<0.5 dB	<0.3 dB
Relative	<0.3 dB	<0.1 dB
<b>Occupied bandwidth (99%)</b>		
Measurement uncertainty	<20 kHz	<20 kHz
<b>Spectrum emission mask</b>		
Level uncertainty		
<3.6 GHz	<0.5 dB	<0.5 dB
3.6 GHz to 13 GHz	<2.5 dB	<2.5 dB
<b>Trigger to frame</b>		
Accuracy	<500 ns	<500 ns (R&S®FSU) <100 ns (R&S®FSQ)

## Ordering information

Application Firmware R&S®FS-K76 and R&S®FS-K77 can be integrated into any member of the R&S®FSU/FSQ or R&S®FSP families.

TD-SCDMA Base Station Test Application Firmware	R&S®FS-K76	1300.7291.02
TD-SCDMA Mobile Station Test Application Firmware	R&S®FS-K77	1300.8100.02
<b>Recommended extras</b>		
High-Power Attenuator 20 dB, 50 W, 0 Hz to 6 GHz	R&S®RDL50	1035.1770.52
TV Trigger/RF Power Trigger (R&S®FSP only)	R&S®FSP-B6	1129.8594.02



Contents Overview

Chapter Overview

Type Index

R&amp;S Addresses





## cdma2000 Base Station Test Application Firmware R&S®FS-K82 1xEV-DO Base Station Test Application Firmware R&S®FS-K84



**Transmitter measurements on 3GPP2 signals with Signal Analyzer R&S®FSQ and Spectrum Analyzers R&S®FSU and R&S®FSP**



**Code domain power measurement on a signal with 9 active channels:**  
Active and inactive channels are displayed in bit-reversed order; inactive channels (noise, interference) are displayed with the base spreading factor. The table also shows the main parameters of the total signal at a glance, as well as the parameters of the marked code channel

### Brief description

The R&S®FS-K82/FS-K84 application firmware packages can be installed on all models of the Signal Analyzers R&S®FSQ and Spectrum Analyzers R&S®FSU/FSP. R&S®FS-K82 enhances the range of applications to include code domain power and modulation measurements on cdma2000 signals for radio configurations 1 to 5. cdmaOne base station signals can be analyzed by using radio configuration 1 or 2. R&S®FS-K84 adds the capability to measure code domain power modulation accuracy on all four channel types (pilot, preamble, MAC and DATA) of a 1xEV-DO base station signal.

Featuring wide dynamic range for adjacent channel power, the R&S®FSQ and the R&S®FSU are ideal tools for cdma2000 base station transmitter measurements in development and production.

The R&S®FSP is the ideal development tool with easy-to-use measurement functions integrated into a cost-effective analyzer – the workhorse for every engineer.

### Main features

- ◆ Adds measurement functions in line with 3GPP2 specifications to the R&S®FSU, R&S®FSQ and R&S®FSP analyzer families
- ◆ R&S®FS-K82: provides the functionality needed for cdma2000 testing
- ◆ R&S®FS-K84: provides 1xEV-DO functionality
- ◆ Provides the functionality needed for base station testing as well as the related parameters

- Code domain power (code domain analyzer)
- Code domain power versus time (R&S®FS-K82)
- Rho
- Error vector magnitude (EVM)
- Peak code domain error
- Power versus symbol
- Symbol constellation
- Channel table
- Code domain error power
- Power versus chip (R&S®FS-K84)

### Measurement overview

Measurement	R&S®FSU/ FSP/FSQ	R&S®FSU/ FSP/FSQ with R&S®FS-K82	R&S®FSU/ FSP/FSQ with R&S®FS-K84
Maximum output power	x	x	x
Frequency error		x	x
Power control dynamic range		x	N/A
Power versus chip		N/A	x
Total power dynamic range		x	x
Occupied bandwidth	x	x	x
Spectrum emission mask		x	x
ACLR	x	x	x
Spurious emissions	x		
Rho		x	N/A
Rho <sub>overall-1</sub>		N/A	x
Rho <sub>overall-2</sub>		N/A	x
Rho <sub>pilot</sub>		N/A	x
Error vector magnitude		x	x
Peak code domain error		x	x
Power versus time			x



## cdma2000 Base Station Test Application Firmware R&amp;S®FS-K82

## Code domain power measurements

The main application is the determination of the power in the individual code channels referred to as code domain power measurement. The power ratios between the individual channels, for instance, can be checked for compliance with the nominal values. Moreover, this measurement is a very efficient tool for detecting transmitter impairments such as clipping or intermodulation that are not obvious from the spectrum alone.

## cdma2000

R&S®FS-K82 supports the analysis of orthogonal transmit diversity signals. Not only the signals for the separate antennas can be studied, but also the combined signal as it is seen by a mobile receiver.

## 1xEV-DO

The code domain analysis in R&S®FS-K84 comprises the analysis of the four different channel types of the signals. The modulation quality of the pilot, preamble, data and MAC parts can be evaluated

separately. The modulation formats and the preamble length are automatically detected.

## Remote control

All measurements can be remote-controlled. The results and demodulated data bits can be transferred via the IEC/IEEE bus. This makes R&S®FS-K82 and R&S®FS-K84 ideal for use in production.

## Specifications

The specifications are based on the data sheet specifications of the Spectrum Analyzer R&S®FSQ, R&S®FSU and R&S®FSP and have not been checked separately. Specifications apply under the following conditions: 15 minutes warm-up time at ambient temperature, specified environmental conditions met, calibration cycle adhered to and internal calibration performed. Data with tolerances are measurement uncertainties with a confidence level of 95%. The specified level measurement errors do not take into account systematic errors due to reduced S/N ratio.

## Common parameters

Measurement	R&S®FSP	R&S®FSU/ R&S®FSQ
<b>Code domain power (applies to code domain power and code domain power versus slot)</b>		
Measurement uncertainty		
Total signal power	<0.5 dB	<0.3 dB
Pilot power	<0.6 dB	<0.4 dB
Code power, absolute	<0.6 dB	<0.4 dB
Code power, relative	<0.1 dB	<0.1 dB
<b>Composite EVM</b>		
Measurement range	1.5% to 25%	1% to 25%
Inherent EVM	<1.5%	<1%
Measurement uncertainty (% of reading)	<0.5	<0.25
<b>Output power</b>		
Measurement uncertainty, absolute	<0.5 dB	<0.3 dB
Measurement uncertainty, relative	<0.2 dB	<0.1 dB
<b>Occupied bandwidth (99%)</b>		
Measurement uncertainty	<85 kHz	<85 kHz
<b>Spurious emissions</b>		
Level uncertainty <3.6 GHz	<0.5 dB	<0.5 dB
Level uncertainty 3.6 GHz to 13 GHz	<2.5 dB	<2.5 dB
<b>Trig to Frame</b>		
Accuracy	<210 ns	<210 ns

## R&amp;S®FS-K82 only

Measurement	R&S®FSP	R&S®FSU/R&S®FSQ
<b>Peak code domain error (PCDE)</b>		
Measurement range	0 dB to 55 dB	0 dB to 60 dB
Inherent PCDE	55 dB	60 dB
<b>Frequency error</b>		
Measurement range	<1 kHz	<1 kHz
Measurement uncertainty (S/N >40 dB) + error of reference frequency	<1.5 Hz	<1.5 Hz

## R&amp;S®FS-K84 only

Measurement	R&S®FSP	R&S®FSU/R&S®FSQ
<b>Peak code domain error (PCDE)</b>		
Measurement range	0 dB to -53 dB	0 dB to -58 dB
Inherent PCDE		
Pilot	-50 dB	-55 dB
MAC	-53 dB	-58 dB
Data	-47 dB	-52 dB
Preamble	-50 dB	-55 dB
Measurement uncertainty	<1 dB (0 dB to -40 dB)	<1 dB (0 dB to -40 dB)
<b>Frequency error</b>		
Measurement range	<8 kHz	<8 kHz
Measurement uncertainty (S/N >40 dB) + error of reference frequency	<1.5 Hz	<1.5 Hz

## Ordering information

Application Firmware R&S®FS-K82 and R&S®FS-K84 can be integrated into any member of the R&S®FSU, R&S®FSQ or R&S®FSP families.

Application Firmware		
cdma2000 Base Station Test	R&S®FS-K82	1157.2316.02
1xEV-DO Base Station Test	R&S®FS-K84	1157.2851.02
<b>Recommended extras</b>		
High-Power Attenuator 20 dB, 50 W, 0 GHz to 6 GHz	R&S®RDL50	1035.1770.52



## cdma2000/1xEV-DV Mobile Station Test Application Firmware R&S®FS-K83



**Transmitter measurements on  
 cdma2000 and 1xEV-DV reverse  
 link with Signal Analyzer  
 R&S®FSQ and  
 Spectrum Analyzers R&S®FSU  
 and R&S®FSP**

**Code domain power measurement on a signal with high data rate transmission**

Active and inactive channels are displayed in bit-reversed order; inactive channels (noise, interference) are displayed with the base spreading factor. The upper half shows the inphase part of the signal, the lower half the quadrature part

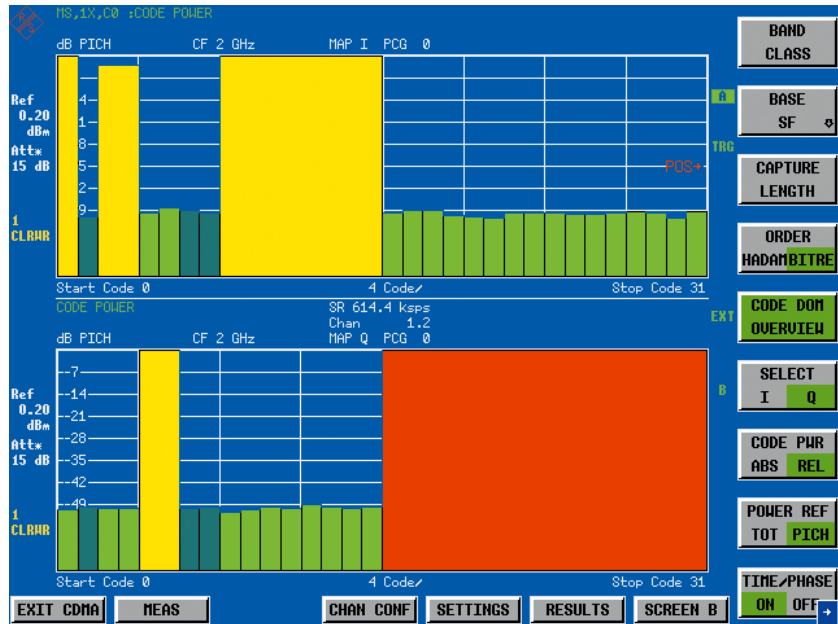

### Brief description

Application Firmware R&S®FS-K83 can be installed on all models of the Signal Analyzers R&S®FSQ and Spectrum Analyzers R&S®FSU and R&S®FSP.

Application Firmware R&S®FS-K83 enhances the range of applications to include code domain power and modulation measurements on cdma2000 signals for radio configurations 3 and 4 and 1xEV-DV revision C signals.

Featuring wide dynamic range for adjacent channel power, the R&S®FSQ and the R&S®FSU are ideal tools for cdma2000 mobile station transmitter measurements in development.

The R&S®FSP is the ideal partner in development and production, featuring low uncertainty in level measurement, high measurement speed as well as excellent RF characteristics.

### Main features

◆ Adds measurement functions in line with 3GPP2 specifications to the R&S®FSU, R&S®FSQ and R&S®FSP analyzer families

- ◆ Provides the functionality needed for mobile station testing as well as the related parameters
  - Code domain power
  - Code domain power versus time
  - Rho

Measurement	R&S®FSU/FSP/FSQ	R&S®FSU/FSP/FSQ with R&S®FS-K83
Maximum output power	X	X
Frequency error	–	X
Power control dynamic range	–	X
Total power dynamic range	–	X
Occupied bandwidth	X	X
Spectrum emission mask	–	X
ACLR	X	X
Spurious emissions	X	–
Rho	–	X
Error vector magnitude	–	X
Peak code domain error	–	X
Time and phase offset	–	X



Contents Overview

Chapter Overview

Type Index

R&amp;S Addresses



## cdma2000/1xEV-DV Mobile Station Test Application Firmware R&amp;S®FS-K83

- Error vector magnitude (EVM)
- Peak code domain error
- Power versus symbol
- Symbol constellation
- Channel table
- Code domain error power

## Code domain power measurements

The main application is the determination of the power in the individual code channels referred to as code domain power measurement. The power ratios between the individual channels, for instance, can be checked for compliance with the nominal values. Moreover, this measurement is a very efficient tool for detecting transmitter impairments such as clipping or intermodulation that are not obvious from the spectrum alone.

## 1xEV-DV

To facilitate higher data rates, revision C of the 1xEV-DV standard has added two new channels for fast acknowledgment and quality indication of the radio channel. These new channels are automatically detected by the firmware.

## Specifications

The specifications are based on the data sheet specifications of the R&S®FSU, R&S®FSQ and R&S®FSP analyzers and have not been checked separately.

Specifications apply under the following conditions: 15 minutes warm-up time at ambient temperature, specified environmental conditions met, calibration cycle adhered to and internal calibration performed. Data with tolerances: measurement uncertainties with a confidence level of 95%. Data without tolerances: typical values. The specified level measurement errors do not take into account systematic errors due to reduced S/N ratio.

Measurement	R&S®FSP	R&S®FSU/FSQ
<b>Code domain power</b> (applies to code domain power and code domain power versus slot)		
Measurement uncertainty		
Total signal power	<0.5 dB	<0.3 dB
Pilot power	<0.6 dB	<0.4 dB
Code power; absolute	<0.6 dB	<0.4 dB
Code power; relative	<0.1 dB	<0.1 dB
<b>Frequency error</b>		
Measurement range uncertainty (S/N >40 dB)	<2 kHz <1.5 Hz + error of reference frequency	<2 kHz <1.5 Hz + error of reference frequency
<b>Composite EVM</b>		
Measurement range	1.5% to 25%	1% to 25%
Inherent EVM	<1.5%	<1%
Measurement uncertainty	<0.5%	<0.25%

Measurement	R&S®FSP	R&S®FSU/FSQ
<b>Peak code domain error</b>		
Measurement range	0 dB to –55 dB	0 dB to –60 dB
Inherent PCDE		
SF = 16	–49 dB	–54 dB
SF = 32	–52 dB	–57 dB
SF = 64	–55 dB	–60 dB
Measurement uncertainty	<1 dB (0 dB to –40 dB)	<1 dB (0 dB to –40 dB)
<b>Output power</b>		
Measurement uncertainty, absolute	<0.5 dB	<0.3 dB
Measurement uncertainty, relative	<0.3 dB	<0.1 dB
<b>Occupied bandwidth (99%)</b>		
Measurement uncertainty	<85 kHz	<85 kHz
<b>Spectrum emission mask</b>		
Level uncertainty		
<3.6 GHz	<0.5 dB	<0.5 dB
3.6 GHz to 13 GHz	<2.5 dB	<2.5 dB
<b>Trigger to frame</b>		
Accuracy	<210 ns	<210 ns

## Ordering information

Application Firmware R&S®FS-K83 can be integrated into any member of the R&S®FSQ, R&S®FSU or R&S®FSP families

<b>cdma2000/1xEV-DV Mobile Station Test Application Firmware</b>	R&S®FS-K83	1157.2416.02
cdma2000 1xEV-DO MS Application Firmware	R&S®FS-K85	1300.6689.02
<b>Recommended extras</b>		
High-Power Attenuator 20 dB, 50 W, 0 GHz to 6 GHz	R&S®RDL50	1035.1770.52



Contents Overview

Chapter Overview

Type Index

R&amp;S Addresses



## Bluetooth Application Firmware R&S® FS-K8

### Bluetooth transmitter measurements with Spectrum Analyzers R&S® FSP and R&S® FSU

#### Measurement of modulation characteristics

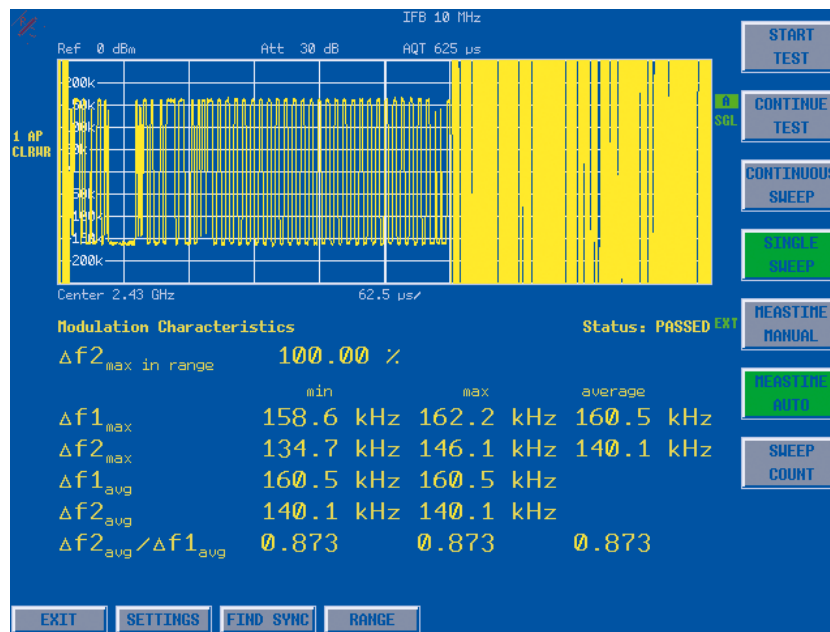

#### Brief description

Application Firmware R&S® FS-K8 enhances the range of applications of the Spectrum Analyzers R&S® FSP and R&S® FSU to include measurements on Bluetooth transmitters. All measurements are carried out in line with the Bluetooth RF Test Specification (Bluetooth SIG) Rev. 1.1. Integrated limit value monitoring is provided for all measurements and allows analysis of the results in the development and production of Bluetooth modules.

#### Main features

- ◆ Enhanced measurement functionality for the spectrum analyzers of the R&S® FSP and R&S® FSU families in line with Bluetooth RF Test Specification (Bluetooth SIG) Rev. 1.1
- ◆ Measurement functions
  - Output power
  - Adjacent channel power (ACP)
  - Modulation characteristics
  - Initial carrier frequency tolerance (ICTF)
  - Carrier frequency drift

- ◆ Simultaneous display of traces and all numerical measurement results
- ◆ Automatic limit value monitoring
- ◆ Ideal for use in development and production of Bluetooth modules

#### Measurements

##### Output power

This measurement is provided for determining the maximum and average output power of the device under test during a burst. A complete packet is recorded in the time domain. The peak power is determined from the total trace contents, whereas the average power is derived from at least 20% to 80% of the burst. Triggering is effected to the sync word.

##### Adjacent channel power (ACP)

This measurement is provided for determining the power of all adjacent channels. The power of up to 79 channels in total can be measured (39 lower channels + TX channel + 39 upper channels).

##### Modulation characteristics

This measurement is provided for determining the maximum frequency deviation of all 8-bit test sequences of the payload. In addition, the average value of the maximum frequency deviations per packet is calculated and displayed.

##### Initial carrier frequency tolerance

This measurement is provided for determining the carrier offset of the four preamble bits. In accordance with the RF test specification, the carrier offset is calculated from the midpoint of the first preamble bit to the midpoint of the bit following the preamble.

##### Carrier frequency drift

This measurement is provided for determining the maximum frequency drift between the average value of the preamble bits and an arbitrary 10-bit group of the payload. The maximum drift rate of the payload is determined in addition.

## Bluetooth Application Firmware R&S®FS-K8

### Specifications

The specifications below are based on the data sheet specifications of the Spectrum Analyzer R&S®FSP and have not been checked separately.

Specifications apply under the following conditions:

15 minutes warm-up time at ambient temperature, specified environmental conditions met, calibration cycle adhered to and internal calibration performed.

Data with tolerances denotes measurement uncertainties with a confidence level of 95%.

Unless otherwise stated, specifications are quoted for an RF input level +30 dBm to -50 dBm within the *Bluetooth* band (ISM) 2400 MHz to 2483.5 MHz and default settings.

Output power	
Measurements	average and peak power to <i>Bluetooth</i> RF Test Specification
Level range	+30 dBm to -50 dBm
Level uncertainty	<0.7 dB (s = 0.25 dB)
Packet type	longest supported (DH1, DH3, DH5)
Payload	PRBS9
Synchronization	RF burst or preamble
Trigger	IF power, external, free run
Modulation characteristics	
Measurements	FM deviation according to <i>Bluetooth</i> RF Test Specification $\Delta f1_{max}$ , $\Delta f2_{max}$ , $\Delta f1_{avg}$ , $\Delta f2_{avg}$ and $\Delta f2_{avg}/\Delta f1_{avg}$
Deviation range	$\pm 250$ kHz
Deviation uncertainty	<3 kHz (signal level >-25 dBm, 10 averages)
Packet type	longest supported (DH1, DH3, DH5)
Payload	10101010 and 11110000, auto detect
Synchronization	preamble
Trigger	IF power, external, free run

Initial carrier frequency tolerance (ICFT)	
Measurements	ICFT to <i>Bluetooth</i> RF Test Specification
Measurement range	$\pm 250$ kHz
Uncertainty	<2 kHz + carrier frequency $\times$ reference error (signal level >-30 dBm)
Packet type	DH1
Payload	PRBS9
Synchronization	preamble
Trigger	IF power, external, free run
Carrier frequency drift	
Measurements	carrier frequency drift to <i>Bluetooth</i> RF Test Specification drift/packet and drift/50 $\mu$ s
Measurement range	$\pm 250$ kHz
Uncertainty	<2 kHz (signal level >-30 dBm)
Packet type	all supported (DH1, DH3, DH5)
Payload	10101010
Synchronization	preamble
Trigger	IF power, external, free run
Adjacent channel power (ACP)	
Measurements	adjacent channel power according to <i>Bluetooth</i> RF Test Specification
Level range	max. +20 dBm
Packet type	DH1
Payload	PRBS9
Synchronization	none
Trigger	external, free run

### Ordering information

Bluetooth Application Firmware for Measurements with R&S®FSP and R&S®FSU	R&S®FS-K8	1157.2568.02



Contents Overview

Chapter Overview

Type Index

R&amp;S Addresses



## WLAN 802.11a Application Firmware R&amp;S®FSP-K90

## Specifications



The specifications of R&S®FSP-K90 are based on the specifications of the Spectrum Analyzer R&S®FSP and have not been checked separately. They are valid under the following conditions:

15 minutes warm-up time at ambient temperature, specified environmental conditions met, calibration cycle adhered to, and internal calibration performed. Data with tolerance limits: measurement uncertainties with a confidence level of 95%. Data without tolerance limits: typical values. The specified level measurement errors do not take into account systematic errors due to reduced S/N ratio.

Frequency	
Frequency range	
RF input	
R&S®FSP3	10 MHz to 3 GHz
R&S®FSP7	10 MHz to 7 GHz
R&S®FSP13	10 MHz to 13.6 GHz
R&S®FSP30	10 MHz to 30 GHz
R&S®FSP40	10 MHz to 40 GHz
Frequency setting	frequency channel number
Level	
Level range (RF input)	50 dBm to +30 dBm
Level setting	autorange, manual
Signal acquisition	
Supported standards	802.11a, 802.11g (OFDM)
Modulation format	BPSK, QPSK, 16QAM, 64QAM
Demodulator setting	manual
Capture length (continuous)	4.06 ms
Number of bursts that can be analyzed	1 to 10922 bursts (manual)
Result length (all evaluations vs. carriers –14 to +14; EVM vs. symbol and vs. carrier, constellation vs. symbol and vs. carrier)	capture length, 1 to 10922 bursts
Sweep time	
Spectrum mask	100 ms
ACPR	300 ms
Burst length (automatic detection of number of data symbols, manual)	1 to 1366 data symbols
Triggering (RF input)	free run, IF power, external

Adjustable parameters	
Pilot tracking	phase on/off, timing on/off, level on/off
Channel estimation	preamble and data, preamble
Measurement uncertainty	
Residual EVM (level 23 dBm to +30 dBm, average of 20 bursts, input = RF (f = 2.4 GHz or 5 GHz))	
Channel estimation = preamble and data	43 dB
Channel estimation = preamble	41 dB
Frequency error	
Lock range	40 ppm
Uncertainty	1 Hz + reference frequency uncertainty
Level uncertainty	
Test of spectrum mask	0.2 dB
Output power	
f < 3.6 GHz	0.5 dB
3 GHz ≤ f ≤ 7 GHz	typ. 1 dB
ACPR (adjacent channel power ratio)	0.5 dB

## Ordering information

WLAN 802.11a Application Firmware	R&S®FSP-K90	1300.6650.02
Spectrum Analyzer, 9 kHz to 3 GHz	R&S®FSP3	1164.4391.03
Spectrum Analyzer, 9 kHz to 7 GHz	R&S®FSP7	1164.4391.07
Spectrum Analyzer, 9 kHz to 13.6 GHz	R&S®FSP13	1164.4391.13
Spectrum Analyzer, 9 kHz to 30 GHz	R&S®FSP30	1164.4391.30
Spectrum Analyzer, 9 kHz to 40 GHz	R&S®FSP40	1164.4391.40
Recommended options and extras	see also data sheet Spectrum Analyzer R&S®FSP	



Contents Overview

Chapter Overview

Type Index

R&amp;S Addresses



[WLAN 802.11a Application Firmware R&S®FSQ-K90](#)  
[WLAN 802.11a/b/g/j Application Firmware R&S®FSQ-K91](#)



**Transmitter measurements on WLAN 802.11 signals with the Signal Analyzer R&S®FSQ:**  
**R&S®FSQ-K90: 802.11a (OFDM only)**  
**R&S®FSQ-K91: 802.11a/b/g/j**

*Constellation diagram of all or (selectable) single carriers*

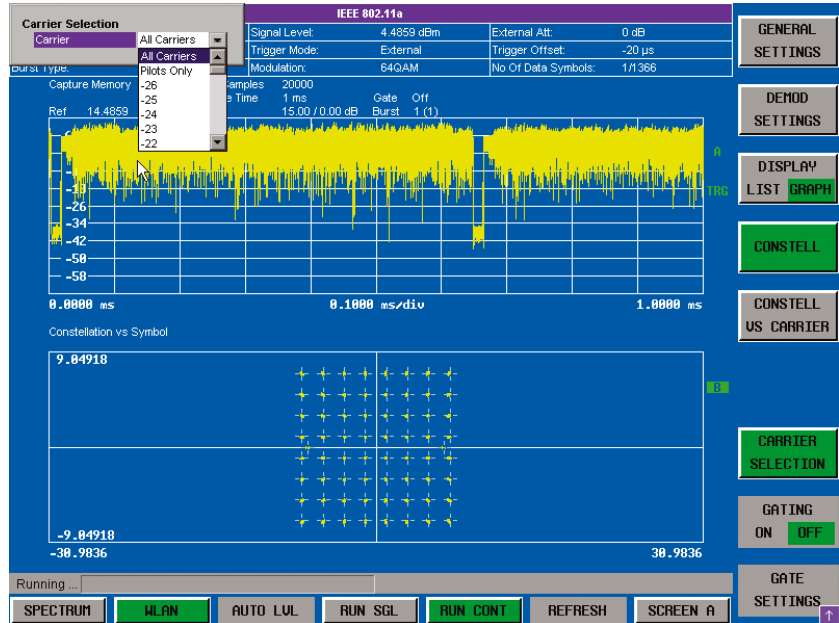

**Brief description**

Application Firmware R&S®FSQ-K90 and R&S®FSQ-K91 expands the application range of the Signal Analyzers R&S®FSQ by spectrum and modulation measurements on OFDM signals in accordance with the WLAN standard IEEE 802.11a. The measurements specified by this standard can thus be performed at a keystroke, for example:

- ◆ Output power (burst power)
- ◆ Spectrum mask with limit lines and PASS/FAIL display
- ◆ Spectrum flatness (including display of group delay)
- ◆ Constellation error
- ◆ RF carrier leakage
- ◆ Carrier frequency and symbol clock error
- ◆ Adjacent channel power

Further analysis and evaluation facilities are often required in the development and verification phase:

- ◆ Constellation diagram for all carriers or a single carrier
- ◆ Constellation overview of all carriers
- ◆ EVM of single carriers
- ◆ EVM versus symbols or time
- ◆ Group delay
- ◆ Time-gated spectrum (FFT)
- ◆ Time-gated CCDF and crest factor
- ◆ Bit stream
- ◆ Analysis at the RF, IF, inverted IF or in the baseband (option R&S®FSQ-B71)
- ◆ Selectable tracking (phase, timing, level)

**Application Firmware R&S®FSQ-K91 additional covers DSS/CCK signals**

- ◆ Modulation formats BPSK, QPSK
- ◆ Data rates 1 Mbps, 2 Mbps, 5.5 MBps (CCK), 11 MBps (CCK)
- ◆ Modulation measurements
- ◆ Constellation diagram
- ◆ EVM according to definition 802.11b
- ◆ IQ offset, imbalance and quadratur error
- ◆ Frequency and symbol clock error
- ◆ Spectrum mask

- ◆ On/Off switching time
- ◆ Amplitude statistics (CCDF and Crest factor)

**Main features**

- ◆ Frequency range from 20 MHz to 3/8/26 GHz, depending on base unit
- ◆ Very low residual EVM of below -44 dB/-46 dB
- ◆ Automatic or manual setting of modulation format
- ◆ Analysis at the RF or in the baseband (optional)
- ◆ All measurement functions remote-controllable via IEC/IEEE bus or LAN
- ◆ High measurement rate of >2 measurements/s (54 Mbps, 16 payload symbols)
- ◆ Supports 802.11g OFDM





Contents Overview

Chapter Overview

Type Index

R&amp;S Addresses



## WLAN 802.11a Application Firmware R&S®FSQ-K90

### WLAN 802.11a/b/g/j Application Firmware R&S®FSQ-K91

#### Specifications in brief

You will find detailed and binding data on the enclosed CD (./DATASHEET/FSQ-K90.pdf), or, for the latest updates, visit [www.rohde-schwarz.com](http://www.rohde-schwarz.com), search term: FSQ-K90

OFDM Analysis (802.11a, 802.11g-OFDM, 802.11j)  
(for R&S®FSQ-K90 only OFDM analysis applies)

Signal acquisition		
Supported standards		802.11a, 802.11g (OFDM), 802.11j (10 MHz), 802.11j (20 MHz)
Modulation format		BPSK, QPSK, 16QAM, 64QAM
Demodulator setting		auto, manual with/without test of signal field
Capture length	continuous	24 µs to 50 ms
Number of bursts that can be analyzed	manual	1 to 10922
Result length	PVT, spectrum FFT, CCDF	capture length, 1 to 10922 bursts or gate length EVM versus symbol and versus carrier, constellation versus symbol/versus carrier, spectrum flatness, bit stream, signal field
Sweep time	spectrum mask	100 ms
	ACPR	300 ms
Burst length	automatic detection of number of data symbols or manual	1 to 1366 data symbols
Triggering	RF input	free run, IF power, external
	I/Q baseband input	free run, envelope of I/Q voltage, external
Result display		
Result list	min/mean/max min/mean/max min/mean/max	EVM all carriers EVM payload I/Q offset gain imbalance quadrature error center freq error symbol clock error mean burst power crest factor
Power vs Time		Full Burst, rising/falling edge
EVM		EVM vs Symbol EVM vs Carrier
Spectrum		Spectrum Mask (IEEE & ETSI) ACP (802.11j: Abs/Rel) Spectrum FFT Spectrum Flatness

#### DSSS/CCK Analysis (802.11b)

Signal acquisition		
Supported standards		802.11b,
Modulation format		DBPSK, DQPSK, CCK, short PLCP, long PLCP

Demodulator setting		auto, manual with/without test of signal field
Capture length	continuous	24 µs to 66 µs
Number of bursts that can be analyzed	manual	1 to 10922
Result length	PVT, spectrum FFT, CCDF	capture length, 1 to 10922 bursts or gate length
	EVM versus symbol and versus carrier, constellation versus symbol bit stream PLCP header	capture length, 1 to 10922 bursts
Sweep time	spectrum mask, ACPR	200 ms
Burst length	automatic detection of number of data symbols or manual	1 to 4095 bytes
Triggering	RF input	free run, IF power, external
	I/Q baseband input	free run, envelope of I/Q voltage, external
Result display		
Result list	min/mean/max min/mean/max	peak vector error burst EVM I/Q offset gain imbalance quadrature error center freq error chip clock error rise time/fall time mean burst power peak burst power crest factor
Power versus Time		up ramp/down ramp
EVM		EVM versus symbol
Spectrum		spectrum mask, ACPR, spectrum FFT
Constellation		constellation diagram
Statistics		bitstream, PLCP header, CCDF
Limit check	Values according to standard	result list, power versus time, EVM, spectrum mask, ACP

#### Ordering information

<b>WLAN 802.11a Application Firmware</b>	R&S®FSQ-K90	1157.3064.02
<b>WLAN 802.11a/b/g/j Application Firmware</b>		
	R&S®FSQ-K91	1157.3129.02
Upgrade from R&S®FSQ-K90 to R&S®FSQ-K91	R&S®FSQ-K90U	1300.8000.02
<b>Recommended extras</b>	see also data sheet Signal Analyzer R&S®FSQ	
I/Q Baseband Inputs	R&S®FSQ-B71	1157.0113.02
I/Q Bandwidth Extension	R&S®FSQ-B72	1157.0336.02



Contents Overview

Chapter Overview

Type Index

R&amp;S Addresses



## TV Trigger/RF Power Trigger R&S® FSP-B6

**Makes the Spectrum Analyzers R&S® FSP suitable for analog TV measurement applications**

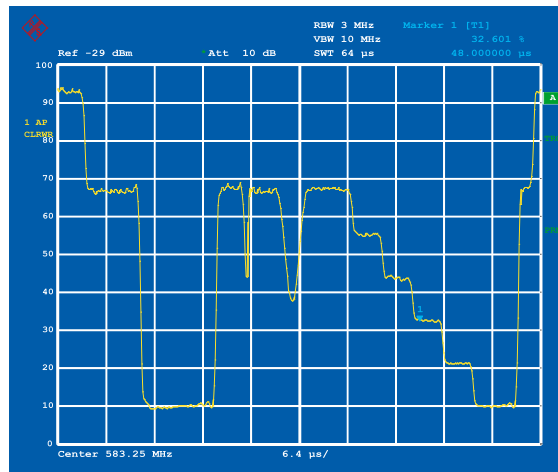

*Amplitude of RF carrier in line 17*

### Brief description

Option R&S® FSP-B6 makes the Spectrum Analyzers R&S® FSP suitable for analog TV measurement applications and provides a settable RF level trigger for measurements on pulsed RF signals that are used in TDMA transmission systems.

### Main features

#### Analog TV applications

- ◆ Standards B/K, D/K, I, L and M
- ◆ Trigger to even, odd field or any line
- ◆ Measurement of modulation quality
- ◆ CCVS signal output
- ◆ Trigger to external CCVS signal

#### RF power trigger

- ◆ Large trigger bandwidth
- ◆ Settable trigger level
- ◆ Measurement on TDMA systems without trigger output

### Specifications in brief

**You will find detailed and binding data on the enclosed CD (./DATASHEET/FSP-B6.pdf), or, for the latest updates, visit [www.rohde-schwarz.com](http://www.rohde-schwarz.com), search term: FSP-B6**

RF trigger	
Trigger source	RF level
Trigger level, setting range	40 dB, settable in 1 dB steps
RF bandwidth	80 MHz

### TV trigger

Measurements on analog TV signals require triggering to specific lines in the video signal. To this end, option R&S® FSP-B6 provides a trigger signal from a TV demodulator. Triggered to the desired line (horizontal sync) or a field (vertical sync), R&S® FSP displays the TV video signal in the time domain. So it is easy to measure the vision carrier amplitude in lines 17 or 18 for instance. The high level accuracy and the excellent display linearity of R&S® FSP ensure high-precision measurements.

R&S® FSP is fitted with a CCVS connector at the rear panel, thus allowing a visual assessment of the picture quality on a connected monitor. The connector is also used as an input to trigger R&S® FSP to an external CCVS signal.

### RF power trigger

Using this feature R&S® FSP can be triggered by means of an RF level. The bandwidth available for triggering is  $\pm 40$  MHz about the R&S® FSP center frequency. The trigger level can be set in a range of 40 dB. This makes it very easy for the user to measure for instance the spectrum due to modulation of TDMA signals such as GSM or EDGE. A trigger from the DUT is not required and also quite often not available. Therefore elaborate additional circuits are not required to generate a trigger signal. In conjunction with the comprehensive R&S® FSP trigger functions such as pre-trigger and trigger-delay, the wide range of resolution bandwidths (10 Hz to 10 MHz) and the high display resolution (min. 31.25 ns), pulsed signals can be investigated in detail with minimum effort.

TV trigger	
Trigger source	internal TV demodulator, video polarity selectable or external CCVS signal
Standards	B/G, D/K, I, L, M
Level range	
RF input	-10 dBm to -40 dBm (mixer level)
CCVS input	500 mV to 2 V (V <sub>pp</sub> )
Triggering	vertical and horizontal TV sync signals, any line within a 625- or 525-line system

### Ordering information

TV Trigger/RF Power Trigger	R&S® FSP-B6	1129.8594.02
-----------------------------	-------------	--------------



Contents Overview

Chapter Overview

Type Index

R&amp;S Addresses



## Harmonic Mixers R&S®FS-Z60/-Z75/-Z90/-Z110

### Frequency range extension to

### 110 GHz for Spectrum Analyzers

R&S®FSP40, R&S®FSU26/46/50,

Signal Analyzer R&S®FSQ26 and

EMI Test Receivers

R&S®ESIB26 and R&S®ESIB40

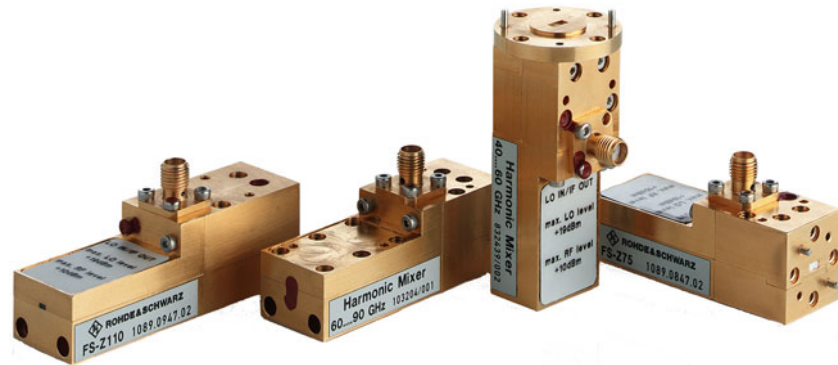

### Brief description

Harmonic Mixers R&S®FS-Z60/-Z75/-Z90/-Z110 extend the frequency range of Spectrum Analyzers R&S®FSEM/K and EMI Test Receivers R&S®ESIB26 and R&S®ESIB40 and Signal Analyzers R&S®FSIQ26.

The mixers are available with standard waveguide flanges to cover the following bands:

- ◆ R&S®FS-Z60:  
40 GHz to 60 GHz (V band)
- ◆ R&S®FS-Z75:  
50 GHz to 75 GHz (V band)
- ◆ R&S®FS-Z90:  
60 GHz to 90 GHz (E band)
- ◆ R&S®FS-Z110:  
75 GHz to 110 GHz (W band)

### Main features

#### No additional biasing required

Due to their double diode design these mixers feature flat frequency response and require no additional biasing which makes them especially suitable for automated measurements. High accuracy requirements are met when operating the mixers with R&S®FSP/FSU/FSQ/ESIB. Therefore the harmonic mixers are suitable for EMC measurement applications.

#### Individual conversion loss table supplied

For each mixer an individual conversion loss table with 50 frequency points is supplied as a hardcopy and as a file on floppy disk. The data file can be transferred to the hard disk of the measuring instruments mentioned above. Once the file is activated, all additionally required parameters for mixer operation will be set automatically. This makes for extreme ease of operation. For quick reference each mixer is labelled with a look-up table with reduced number of data points.

#### High sensitivity

The low conversion loss and the high LO frequency range enable the user to measure even very low level signals.

#### High large-signal immunity

With a typical 1 dB compression point of +6 dBm and low conversion loss the mixers feature a very high dynamic range. Measurements of low level signals are possible even in the presence of high level signals, which considerably facilitates practical use.

#### Transparent spectrum display

Due to the high LO frequency (up to 15.2 GHz) and the resultant low order of harmonics used the number of unwanted responses is low. This yields a highly transparent spectrum display. Additionally the unwanted components can be automatically identified and suppressed by R&S®FSP/FSU/FSQ/ESIB.

#### Wide image-free frequency range

When operated with the R&S®FSP/FSU/FSQ/ESIB the high intermediate frequency of 741.4 MHz results in a wide frequency range without the display of image frequency responses. With low level input signals an image-free frequency range of 1482.8 MHz is obtained. This is sufficient for many applications and allows signal identification without additional measures being required.



Contents Overview

Chapter Overview

Type Index

R&amp;S Addresses





## Harmonic Mixers R&S®FS-Z60/-Z75/-Z90/-Z110

### Specifications

Frequency range/level	R&S®FS-Z60	R&S®FS-Z75	R&S®FS-Z90	R&S®FS-Z110
Frequency range	40 GHz to 60 GHz	50 GHz to 75 GHz	60 GHz to 90 GHz	75 GHz to 110 GHz
Maximum input level (LO level <19 dBm) CW RF CW RF (+40°C to +60°C)			+16 dBm +13 dBm	
1 dB compression			+6 dBm nominal	
Odd-order suppression			typ. 20 dB	
Conversion loss (when used with R&S®FSE/FSIQ/ESIB)	≤25 dB, typ. 18 dB	≤34 dB, typ. 25 dB	≤37.5 dB, typ. 34 dB	≤40 dB, typ. 32 dB
Frequency response within any 5-GHz band	<3 dB	<3 dB	<5 dB	<6 dB
<b>Displayed average noise level</b> when used with R&S®FSE/R&S®FSIQ/ESIB (RBW 1 kHz, VBW 100 Hz, 20 averages, trace average)	≤-107 dBm typ. -114 dBm	≤-98 dBm typ. -107 dBm	≤-94 dBm typ. -98 dBm	≤-92 dBm typ. -100 dBm
<b>Measurement uncertainty</b>				
Level uncertainty (95% confidence level, when used with R&S®FSE/R&S®FSIQ/ESIB) LO level +12.5 to +18.5 dBm)			<3.0 dB (+25°C) <4.5 dB (+5°C to +40°C)	
Temperature drift (max.) +5°C to +40°C -20°C to +60°C			<1.5 dB <2.5 dB	
<b>RF input</b>	WR 19, UG-383/ U-M flange (modified)	WR 15, UG-385/ U flange	WR 12, UG-387/ U flange	WR 10, UG-387/ U-M flange (modified)
VSWR	<3.5:1, typ. 2.2:1	<3.5:1, typ. 2.2:1	<3.6:1, typ. 2.5:1	<3:1, typ. 2.3:1
<b>LO input/IF output</b>				
Connector	SMA-connector			
LO signal				
Frequency range	9.81 GHz to 15.19 GHz	8.21 GHz to 12.62 GHz	8.21 GHz to 12.62 GHz	9.4 GHz to 14 GHz
Harmonic number	4	6	6	8
Optimum LO level	+15.5 dBm	+15.5 dBm	+15.5 dBm	+14 dBm
Maximum LO level			+19 dBm	
IF signal				
IF (nom.)	741.4 MHz	741.4 MHz	741.4 MHz	–
<b>General data</b>				
Nominal temperature range			+5°C to +40°C	
Limit temperature range			-20°C to +60°C	
Dimensions in mm (W × H × D)	28.6 × 33.8 × 63.5	20 × 29.5 × 60	20 × 29.5 × 60	28.6 × 33.8 × 63.5
Weight	170 g	150 g	150 g	150 g

### Ordering information

Harmonic Mixer		
40 GHz to 60 GHz	R&S®FS-Z60	1089.0799.02
50 GHz to 75 GHz	R&S®FS-Z75	1089.0847.02
60 GHz to 90 GHz	R&S®FS-Z90	1089.0899.02
75 GHz to 110 GHz	R&S®FS-Z110	1089.0947.02
Required option for external mixing (for R&S®FSEK/M, R&S®ESIB26/40, R&S®FSIQ26)	R&S®FSE-B21	1084.7243.02
Accessories supplied <sup>1)</sup>		
Operating manual, disk with conversion loss data, chart with conversion loss data, carrying case		

1) Connection cable is supplied with option R&S®FSE-B21.



## Vector Network Analyzers R&S®ZVB

Frequency ranges up to

R&S®ZVB4: 4 GHz

R&S®ZVB8: 8 GHz

with 2 or 4 measurement ports

**New**



### Brief description

The network analyzers of the R&S®ZVB family feature an innovative reflectometer concept that sets new standards. Each test port is provided with a separate generator, measurement channel and reference channel. This concept of independent reflectometers allows parallel measurements to be performed, a precondition for higher levels of performance even as the complexity of measurement tasks steadily increases. Based on this concept, the R&S®ZVB is especially able to carry out multipoint measurements extremely quickly, e.g. on balanced SAW filters, duplex filters or antenna switching modules.

The R&S®ZVB combines excellent performance with low weight and compact design. Intelligent and user-friendly functions offer maximum ease of operation. They allow, for example, the large number of measured quantities involved in multipoint and balanced measurements to be handled easily, and also offer a variety of ways to optimize production sequences – a smart solution that satisfies even the most exacting demands.

### Main features

- ◆ Multipoint measurements
- ◆ Balanced measurements, mixed-mode S parameters
- ◆ Separate generator for each test port
- ◆ Parallel measurements
- ◆ Calibration techniques:
  - TOSM, TRL/LRL, TOM, TRM, TNA
  - Multipoint calibration techniques
  - Model-adaptable standards
- ◆ Extremely fast measurement times with simultaneous data transfer
- ◆ Dynamic range >123 dB
- ◆ IF bandwidths 1 Hz to 500 kHz
- ◆ Level sweep range 50 dB
- ◆ Up to 20001 points per trace
- ◆ Unlimited number of independent channels and traces
- ◆ Parallel loading of setups (preloading, setup swap)
- ◆ Operation via front-panel keys or mouse and keyboard
- ◆ Online help
- ◆ Measurement wizard
- ◆ Optimization of production sequences

### Characteristics

The innovative concept implemented in the R&S®ZVB significantly enhances the analyzer's performance in terms of measurement speed, available configuration options and system characteristics. The test set is made up of independent reflectometer units, each with a separate generator, measurement channel and reference channel for the individual test ports. The use of a common frequency reference ensures high measurement accuracy and frequency selectivity. Electronic switches for forward/reverse switchover of measurement paths are not required in the test set. For this reason, no asymmetries occur between the analyzer test ports as may otherwise be the case as a result of the cascading of switches.

This means, for example, that the maximum output power of up to +13 dBm is available at each of the four test ports irrespective of the direction of measurement. With a specified dynamic range of >123 dB, the R&S®ZVB features very fast measurement times - even for applications requiring an extremely wide dynamic range.



Contents Overview

Chapter Overview

Type Index

R&amp;S Addresses



## Vector Network Analyzers R&S®ZVB

The instrument concept of independent reflectometers also allows parallel measurements to be performed at maximum speed. With its two or four internal generators, the analyzer carries out measurements on different port groups of a DUT simultaneously and independently. For example, the four parameters S11 to S44

representing the reflection coefficients of a four port DUT can be simultaneously measured and displayed, provided that there is adequate isolation between the ports. This reduces measurement time by a factor of approx. 4 compared with instruments featuring just one generator and an internal RF switch. Data process-

ing in the instrument is also carried out in parallel, ranging from RF and IF through to digitization and display. Moreover, data transfer can be performed simultaneously with measurement. This means extremely fast measurement times even with complex tasks such as multipoint measurements.

### Functions and options

Function	Description	Standard/option
Two test ports	Integrated bidirectional RF test ports	Standard
Four test ports	Integrated bidirectional RF test ports	Standard
Active test set (PORT BIAS)	Input of DC power for supply of amplifiers via inner conductor of test port; requires external DC power supply	Standard
Multipoint measurements	Complete S parameter matrix, wave quantities, wave quantity ratios, impedances, admittances, Z and Y parameters of multipoint DUTs	Standard
Balanced measurements	Mixed-mode S parameters, mixed-mode Z and Y parameters, impedances and admittances of balanced DUTs	Standard
Calibration techniques	TOSM, TRL/LRL, TOM, TRM, TNA, normalization	Standard
Unlimited number of measurement diagrams, traces, decoupled measurements	Any number of traces can be created and freely assigned to measurement diagrams; simultaneous display of decoupled measurements	Standard
Setup swap; preloading	Several instrument setups can be loaded simultaneously into RAM; fast switchover between instrument setups	Standard
Segmented sweep, lin/log sweep	Optimization of sweeps by focusing on frequency ranges of interest	Standard
Level sweep; time-domain sweep	Measurement of DUT compression; determination of measured quantities as a function of time	
20001 points per trace	High frequency resolution for swept measurements	Standard
IF bandwidths 1 Hz to 500 kHz (in 1/2/5 steps)	Optimization of measurement speed and dynamic range	Standard
Level sweep	Wide level sweep range of 50 dB for compression measurements (no attenuators required)	Standard
Online support functions	Online help for current function, UNDO function for resetting the last one to five entries, Windows XP key for accessing the operating system, complete listing of current instrument setup	Standard
Measurement wizard	Step-by-step guidance through desired instrument setup, including calibration if required	Standard
Trace mathematics, equation editor, marker functions, trace statistics	Functions for online processing of measured data, linking of traces by means of any type of equations, for adjustments and statistical analyses	Standard
Limit lines	Online generation of envelopes from traces; import (and export) of data for limit lines	Standard
Trigger functions	Trigger options for starting a sweep, sweep segment, frequency point or partial measurement	Standard
Power viewer	Functions as a power meter: values derived from a USB sensor are displayed as a trace, requires Rohde&Schwarz power sensor with USB interface	Software
Oven-controlled crystal oscillator	Enhanced frequency accuracy	Option R&S®ZVAB-B4
COM/DCOM control	Control of R&S®ZVB firmware by external programs	Standard
Interfaces (2 × LAN, 4 × USB, IEC BUS, 10 MHz REF, MONITOR, USER CONTROL, EXT TRIGGER)	Control of R&S®ZVB, control of external devices or handlers by R&S®ZVB, fast TTL handler and sequence control, connection of peripherals, e.g. printer or storage media (see also interface description)	Standard
DC MEAS inputs	Measurement inputs for DC voltage, allowing PAE (power added efficiency) measurements	Standard



Contents Overview

Chapter Overview

Type Index

R&amp;S Addresses





Contents Overview

Chapter Overview

Type Index

R&amp;S Addresses



## Vector Network Analyzers R&amp;S®ZVB

## Specifications in brief

You will find detailed and binding data on the enclosed CD (./DATASHEET/ZVB.pdf), or, for the latest updates, visit [www.rohde-schwarz.com](http://www.rohde-schwarz.com), search term: ZVB

Measurement range	
Number of test ports	4
Frequency range	
R&S ZVB4	300 kHz to 4 GHz
R&S ZVB8	300 kHz to 8 GHz
Frequency resolution	100 µHz
Number of measurement points	user-selectable, 1 to 20001
Time for measurement and data transfer for 201 measurement points (No additional time for data transfer is needed, as it is performed simultaneously during the measurement.)	<8 ms
Measurement bandwidths 1/2/5 steps	1 Hz to 500 kHz
Dynamic range	
between PORT 1 and PORT 2 and between PORT 3 and PORT 4 without system error correction at 10 Hz measurement bandwidth	
500 MHz to 4 GHz	>123 dB
Measurement accuracy	
Uncertainty of transmission measurements	
Above 50 MHz, for +5 dB to -60 dB	0.1 dB or 1°
Uncertainty of reflection measurements	
Above 300 kHz, for +3 dB to -15 dB	0.4 dB or 3°
Effective system data (up to 4 GHz)	
Directivity	>46 dB
Source match	>40 dB
Reflection tracking	>0.04 dB
Load match	>46 dB
Transmission tracking	>0.06 dB

Test port output	
Power range, 50 MHz to 4 GHz	-40 dBm to +13 dBm
Power uncertainty at -10 dBm without power calibration above 50 MHz (18 °C to 28 °C)	2 dB
Harmonics, 50 MHz to 4 GHz at +10 dBm	<-20 dBc
Test port input	
Match without system error correction up to 4 GHz	>16 dB
Maximum nominal input level	+13 dBm
Power measurement uncertainty, at -10 dBm without power calibration (18 °C to 28 °C), above 10 MHz	1 dB
Noise level, at 10 Hz measurement bandwidth, 100 MHz to 4 GHz	<-110 dBm
Interfaces	
IEC/IEEE BUS	remote control, IEEE488, IEC60625
LAN 1/LAN 2	2 network connectors, RJ-45
USB	2 connectors for USB devices (USB 1.1); 2 additional USB connectors on the front panel
MONITOR	IBM-PC-compatible VGA monitor connector, 15-pin Sub-D (for ext. monitor)
SER CONTROL	several control and trigger signals, 25-pin Sub-D, 3.3 V TTL for controlling external generators, for limit checks, sweep signals, etc
General data	
Display	21 cm (8.4") diagonal colour LCD
Resolution	800 × 600 × 262144 (high colour)
Operating temperature range	5 °C to 40 °C
Power supply	100 V to 240 V (AC) ±10% 50 Hz to 60 Hz ±5%
Power consumption	450 W, typ. 350 W (standby: typ. 10 W)
Dimensions ( W × H × D )	435 mm × 234 mm × 350 mm
Weight	20 kg



Contents Overview

Chapter Overview

Type Index

R&amp;S Addresses



## Vector Network Analyzers R&S®ZVB

### Ordering information

Order designation	Type	Frequency range	Order No.
<b>Vector Network Analyzers</b>			
Vector Network Analyzer, 2 ports	R&S®ZVB4	300 kHz to 4 GHz	1145.1010.04
Vector Network Analyzer, 2 ports	R&S®ZVB8	300 kHz to 8 GHz	1145.1010.08
Vector Network Analyzer, 4 ports	R&S®ZVB4	300 kHz to 4 GHz	1145.1010.06
Vector Network Analyzer, 4 ports	R&S®ZVB8	300 kHz to 8 GHz	1145.1010.10
<b>Options</b>			
Oven-Controlled Crystal Oscillator (OCXO)	R&S®ZVAB-B4		1164.1757.02
<b>Extras</b>			
<b>Test Cables</b>			
N (m)/N (m), 50 Ω	R&S®ZV-Z11	0 Hz to 18 GHz	1085.6505.03
N (m)/PC 3.5 mm, 50 Ω	R&S®ZV-Z13	0 Hz to 18 GHz	1134.3997.02
<b>Calibration Kits</b>			
N, 50 Ω	R&S®ZV-Z21	0 Hz to 18 GHz	1085.7099.02
N, 50 Ω	R&S®ZCAN	0 Hz to 3 GHz	0800.8515.52
PC 3.5 mm	R&S®ZV-Z32	0 Hz to 26.5 GHz	1128.3501.02
PC 3.5 mm (incl. sliding matches)	R&S®ZV-Z33	0 Hz to 26.5 GHz	1128.3518.02
TRL Suppl. Kit, N, 50 Ω	R&S®ZV-Z26	0.4 Hz to 18 GHz	1085.7318.02
TRL Suppl. Kit, PC 3.5 mm	R&S®ZV-Z27	0.4 Hz to 26.5 GHz	1085.7401.02
<b>Sliding Matches</b>			
N (m), 50 Ω	R&S®ZV-Z41	1.7 GHz to 18 GHz	1085.8095.02
N (f), 50 Ω	R&S®ZV-Z41	1.7 GHz to 18 GHz	1085.8095.03
N, PC 3.5 mm, 50 Ω (m/f pair)	R&S®ZV-Z42	0 Hz to 26.5 GHz	1128.3524.02
<b>Hardware and Measurement Add-Ons</b>			
USB Compact Keyboard	R&S®ZV-Z75		1157.6870.03
USB Mouse <sup>1)</sup>	R&S®ZV-Z76		1157.7060.02
Cable for DC Input <sup>2)</sup>	R&S®ZV-Z71		1164.1005.02
Bias Network	R&S®ZV-Z61	2 MHz to 4 GHz	1106.8130.02
DC Block	R&S®FSE-Z3	5 MHz to 7 GHz	4010.3895.00
Power Splitter 2 × 50 Ω	R&S®RVZ	0 Hz to 2.7 GHz	0800.6612.52
<b>Attenuators</b>			
1 W	R&S®DNF	0 Hz to 12.4 GHz	0272.4x10.50 <sup>3)</sup>
50 W	R&S®RBU50	0 Hz to 2 GHz	1073.8695.xx <sup>4)</sup>
100 W	R&S®RBU100	0 Hz to 2 GHz	1073.8495.xx <sup>4)</sup>
<b>Matching Pads 50 Ω → 75 Ω</b>			
Series resistor	R&S®RAZ	0 Hz to 2.7 GHz	0358.5714.02
L-section	R&S®RAM	0 Hz to 2.7 GHz	0358.6514.02
<b>Miscellaneous</b>			
19" Rack Adapter with front handles	R&S®ZZA-511		1096.3290.00

- 1) Supplied as standard.
- 2) Mini DIN female to four banana plugs.
- 3) x = 0:3 dB, x = 1:6 dB, x = 2:10 dB, x = 3:20 dB, x = 4:30 dB.
- 4) xx = 03:3 dB, xx = 06:6 dB, xx = 10:10 dB, xx = 20:20 dB, xx = 30:30 dB.

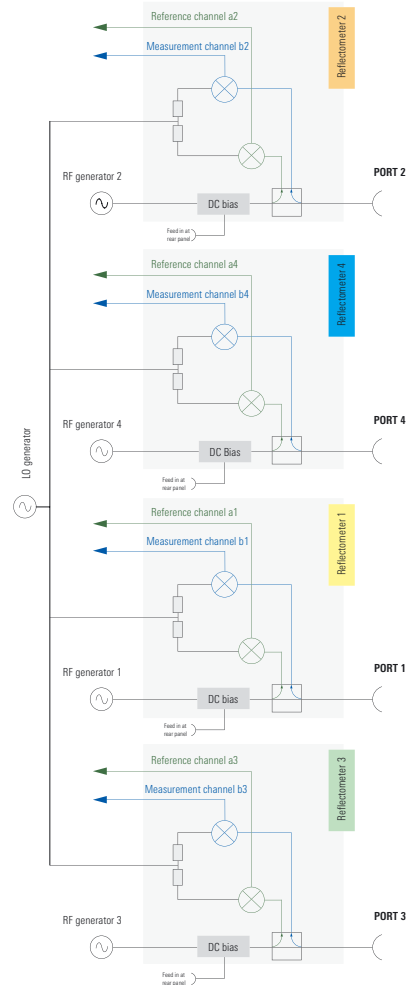

Testset R&S®ZVB: 4 port model

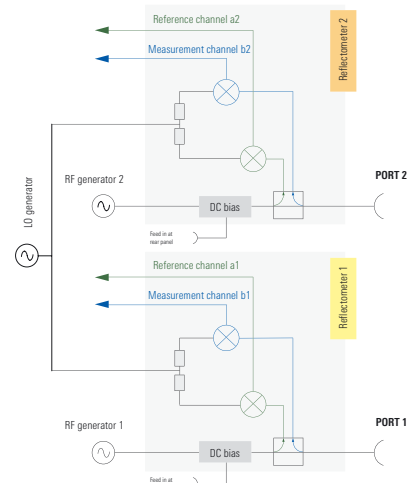

Testset R&S®ZVB: 2 port model



## Vector Network Analyzers R&S®ZVM, R&S®ZVK

**R&S®ZVM: 10 Hz to 20 GHz**

**R&S®ZVK: 10 Hz to 40 GHz**

**Extremely fast, high-precision and  
versatile vector network analyzers**

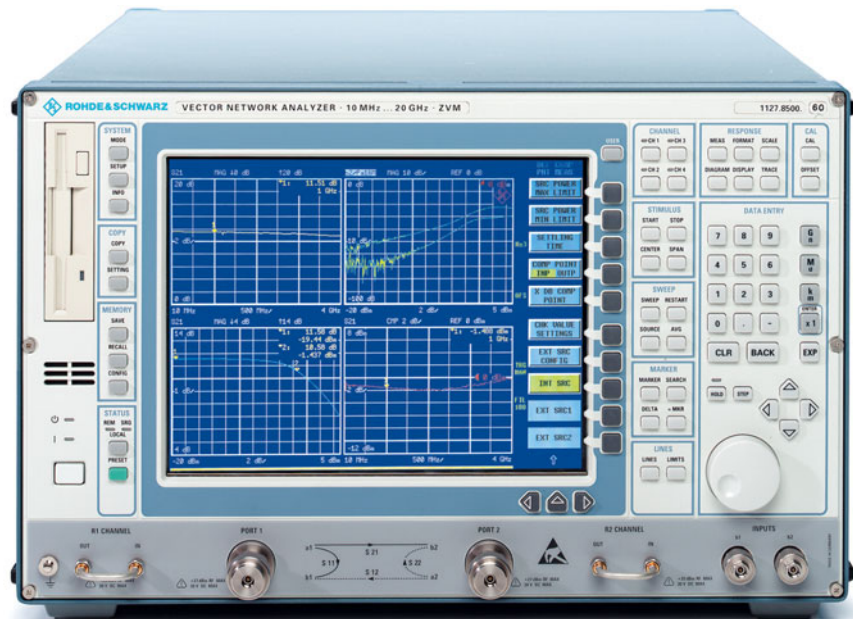

*Vector Network Analyzer R&S®ZVM*

### Brief description

R&S®ZVM and R&S®ZVK extend the frequency range of the Rohde&Schwarz network analyzers to 20 GHz and 40 GHz. Their outstanding performance in terms of speed, dynamic range and accuracy shows already in standard applications such as S-parameter or group delay measurements. In addition, R&S®ZVM and R&S®ZVK can be used for complex measurement tasks, for example measurements on frequency-converting DUTs (conversion loss, intermodulation, spurious) and nonlinear measurements (intercept point and compression point).

### Short measurement times

A powerful microprocessor system combined with ultra-fast synthesizers makes for extremely short measurement times even with a large number of test points and small measurement bandwidths. This in conjunction with short IEC/IEEE bus access and transfer times considerably speeds up automated test and production sequences.

### Wide dynamic range

The extremely low-noise front end, using fundamental mixing, yields a dynamic range that, with appropriate configuration, by far exceeds the specified values of 115 dB and 110 dB. This exceptionally wide range makes it possible to measure RF components with high stopband attenuation and achieve high accuracy also at low power levels.

### Measurements on linear and nonlinear components

The system concept of R&S®ZVM and R&S®ZVK with two independent synthesizers for the generator and receiver sections enables versatile measurements with excellent accuracy, wide dynamic range and high measurement speed on linear and nonlinear DUTs such as amplifiers and mixers. Three generators (one internal, two external) can be configured and controlled independently of each other. The fundamental mixing concept of R&S®ZVM and R&S®ZVK and the resulting high selectivity make additional external filters superfluous. The receiver will

even detect weak signals such as intermodulation products and spurious, since the full sensitivity and dynamic range of R&S®ZVM and R&S®ZVK are available also for frequency-converting DUTs.

Typical measurements on amplifiers, frequency converters, multipliers, dividers, synthesizers etc are:

- ◆ Sidebands of mixers with fixed or tracking IF
- ◆ Any harmonics versus frequency or power
- ◆ Intermodulation products of amplifiers and mixers (e.g. IP3, IP5, IP7...)
- ◆ Spurious
- ◆ Mixture products of DUTs with multiple frequency conversion, multipliers, dividers and combinations of such components
- ◆ K factor
- ◆ Power added efficiency (PAE)



Contents Overview

Chapter Overview

Type Index

R&S Addresses



## Vector Network Analyzers R&S®ZVM, R&S®ZVK

	R&S®ZVM	R&S®ZVK
<b>Frequency range</b>	10 MHz to 20 GHz	10 MHz to 40 GHz
<b>Frequency resolution</b>	100 µHz	
<b>Impedance</b>	50 Ω	
<b>Test ports</b>	PC 3.5 male	2.92 mm male
<b>Measurement time (normalized)</b>	<0.5 ms/point	<0.7 ms/point
<b>Output power</b>	+5 dBm/+2 dBm to -85 dBm	0 dBm/-5 dBm to -85 dBm
<b>Power uncertainty</b>	<1 dB to 2 dB	
<b>Dynamic range<sup>1)</sup> (IF bandwidth 10 Hz)</b>	>85 dB (<0.5 GHz) >115 dB (0.5 GHz to 8 GHz) >110 dB (8 GHz to 16 GHz) >100 dB (16 GHz to 20 GHz)	>80 dB (<0.5 GHz) >110 dB (0.5 GHz to 8 GHz) >105 dB (8 GHz to 16 GHz) >90 dB (16 GHz to 20 GHz) >90 dB (20 GHz to 28 GHz) >80 dB (28 GHz to 40 GHz)
<small><sup>1)</sup> When using direct receiver access, dynamic range and sensitivity are increased to typ. 10 dB</small>		
<b>Measurement bandwidths</b>	1 Hz to 10 kHz (in 9 steps) and 26 kHz	
<b>Calibration techniques</b>	TOM, TRM, TNA, TOM-X, AutoKal (all Rohde&Schwarz patents), TRL, TOSM, normalization techniques	

### Embedding and de-embedding of virtual networks, CAE software

The Virtual Embedding Networks option enables virtual embedding of arbitrary linear two-port networks into the test setup.

In testing for example components that have to be matched to a given impedance, an automatic embedding process allows the necessary matching network to be taken into account through mathematical algorithms of R&S®ZVM and R&S®ZVK. Conversely, by de-embedding, the influence of a known network can be eliminated.

The required data (\*.S1P, \*.S2P, \*.S4P, \*.flp) are obtained from a measurement of the existing network or generated by CAE tools from the theoretical model.

### Time-domain measurements

By transforming measurement data from the frequency to the time domain, discontinuities or impedances along the DUT

can be displayed as a function of DUT length. With a maximum number of 2001 points, R&S®ZVM and R&S®ZVK can measure even very long DUTs with high resolution. Five filters allow the location of a discontinuity and the sidelobe suppression to be determined with optimum resolution. The S-parameters of a given discontinuity can be displayed in the time domain by setting a window (gating).

### Special calibration techniques

R&S®ZVM and R&S®ZVK feature modern calibration techniques patented by Rohde&Schwarz that allow full two-port calibration using fewer or only partially known standards. This simplifies the design of calibration standards used for example in test fixtures or on wafers. Thus calibration in non-coaxial systems can be performed with a minimum of effort at maximum accuracy and dynamic range.

### Internal PC and Ethernet

R&S®ZVM and R&S®ZVK are based on Windows NT. The user has complete access to the hard disk, the floppy disk drive and all interfaces of the internal PC. This allows, for example, the connection of an external monitor, the installation of any type of printer, or the use of software tools on R&S®ZVM or R&S®ZVK for result processing or control of the network analyzers via the IEC/IEEE bus or an internal RSIB data bus. R&S®ZVM and R&S®ZVK can thus act as controllers of their own or for a complete test or production system. Moreover, the internal PC enables control and data exchange via Ethernet.

Test set of R&S®ZVM and R&S®ZVK

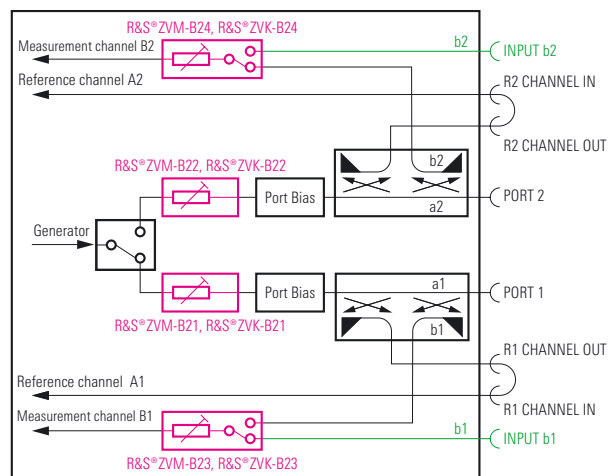

Contents Overview

Chapter Overview

Type Index

R&S Addresses





Contents Overview

Chapter Overview

Type Index

R&amp;S Addresses



## Vector Network Analyzers R&amp;S®ZVM, R&amp;S®ZVK

## Specifications in brief

You will find detailed and binding data on the enclosed CD (./DATASHEET/ZVM\_K.pdf), or, for the latest updates, visit [www.rohde-schwarz.com](http://www.rohde-schwarz.com), search term: ZVM

Unless otherwise stated, specifications apply to test ports PORT 1 and PORT 2, a nominal output power of -10 dBm at the source port and an IF bandwidth  $\leq 10$  kHz.

## Measurement range

<b>Characteristic impedance</b>	50 $\Omega$		
<b>Port connectors</b>			
R&S®ZVM	3.5 mm (male)		
R&S®ZVK	2.92 mm (male)		
<b>Frequency</b>			
Range R&S®ZVM	10 MHz to 20 GHz		
Range R&S®ZVK	10 MHz to 40 GHz		
Uncertainty	$4 \times 10^{-6} + 1 \times 10^{-6} \times$ operating time in years		
Resolution	100 $\mu$ Hz		
<b>Number of test points</b>	1 to 2001 (selectable)		
<b>Measurement time per point</b>			
with min. 400 points	R&S®ZVM	R&S®ZVK	
and IF bandwidth of	10 Hz	10 kHz	10 kHz
with system error correction	<200 ms	<0.9 ms	<1.1 ms
normalized	<100 ms	<0.5 ms	<0.7 ms
<b>Dynamic range</b> (without system error correction, specified at IF bandwidth of 10 Hz, without optional attenuator, typical values are approx. 10 dB higher)			
R&S®ZVM	>115 dB		
R&S®ZVK	>110 dB		
<b>Measurement bandwidths</b>			
(IF bandwidths)	1 Hz to 10 kHz (half-decade steps) and 26 kHz (full)		

## Measurement accuracy

After system error correction:  
Specifications are based on a matched DUT, an IF bandwidth of 10 Hz, and a nominal output power of -10 dBm at the source port. Better values can be achieved depending on calibration kit. Dependence on frequency see data sheet

<b>R&amp;S®ZVM uncertainty</b>		
Transmission measurements	0.1 dB or 1°	
Reflection measurements	0.4 dB or 3°	
<b>R&amp;S®ZVK uncertainty</b>		
Transmission measurements	0.1 dB or 1°	
Reflection measurements	1 dB or 6°	

## Effective system data

<b>Frequency range</b>	<b>50 MHz to 20 GHz</b>		<b>above 20 GHz</b>
	<b>R&amp;S®ZVM</b>	<b>R&amp;S®ZVK</b>	<b>R&amp;S®ZVK</b>
Directivity	>46 dB	>42 dB	>38 dB
Source match	>36 dB	>36 dB	>33 dB
Reflection tracking	<0.1 dB	<0.1 dB	<0.1 dB
Load match	>46 dB	>42 dB	>38 dB
Transmission tracking	<0.1 dB	<0.1 dB	<0.2 dB

## Output power

<b>Range</b> (without optional generator step attenuator)	<b>R&amp;S®ZVM</b>	<b>R&amp;S®ZVK</b>
up to 16 GHz	-20 to +5 dBm	-20 to 0 dBm
above 16 GHz	-20 to +2 dBm	-20 to -5 dBm
<b>Uncertainty at -10 dBm</b>		
150 MHz to 16 GHz (20°C to 26°C)	1 dB	1 dB
<b>Linearity (referred to -10 dBm)</b>		
above 150 MHz (20°C to 26°C)	<0.4 dB	<0.4 dB
<b>Resolution</b>	0.1 dB	0.1 dB

## Spectral purity

<b>Harmonics</b>		
at maximum nominal source power	<-23 dBc	<-25 dBc
at -10 dBm source power	<-30 dBc	<-30 dBc
<b>Spurious</b>	<-35 dBc	<-35 dBc
<b>SSB phase noise</b>		
1 Hz bandwidth, 10 kHz from carrier	up to <-100 dBc	

## Input level

<b>Maximum nominal input level</b>	
without optional receiver step attenuator	+5 dBm
with receiver step attenuator set to $\geq 30$ dB	+27 dBm
<b>Damage level</b>	
without optional receiver step attenuator	+27 dBm
with receiver step attenuator set to $\geq 30$ dB	+30 dBm
<b>RMS noise level</b>	
at IF bandwidth 10 Hz	up to <-110 dBm

## Reference channel inputs

<b>R CHANNEL IN</b>	<b>R&amp;S®ZVM</b>	<b>R&amp;S®ZVK</b>
Connectors	SMA (female)	2.92 mm (female)
Maximum nominal input level	+5 dBm	+5 dBm
Damage level	+20 dBm	+20 dBm

## Display

Screen	26 cm colour LCD, VGA, 256 Colors
Sweep modes	frequency, power, and time
Parameter formats (examples)	S parameters and derived quantities like SWR, impedance, admittance, group delay, etc, as well as nonlinear parameters (optional) like n dB compression point, SOI and TOI Complex parameters are displayed either in a complex form or formatted to magnitude, phase, real or imaginary part
Diagrams (examples)	Cartesian: linear, simple or double logarithmic, segmented polar: linear, logarithmic or segmented, Smith (any zoom), inverted Smith, Charter
Scaling (examples)	0.001 dB to 50 dB; 1 m° to 200 k°; 1 pU to 1 GU (automatically variable number of grid lines through MAX/MIN scaling)
Multichannel display	up to 4 independent display channels
Screen formats (examples)	overlay, dual/quad channel split
Markers	8 normal markers or 7 delta markers for each display channel
Marker resolution	4 significant digits



Contents Overview

Chapter Overview

Type Index

R&amp;S Addresses





Contents Overview

Chapter Overview

Type Index

R&amp;S Addresses



## Vector Network Analyzers R&amp;S®ZVM, R&amp;S®ZVK

Marker formatting	selectable, independent of trace formatting
Automatic marker functions	marker tracking, marker search, marker target, band filter functions (Q, shape factor, etc)
Trace mathematics	all four arithmetical operations with up to three operands
Display lines	horizontal lines, circles or radial lines
Limit lines	pairs of curves formed from line segments in Cartesian diagrams, any circles in polar diagrams

## Further connectors (rear panel)

PORT BIAS 1/2	DC bias inputs for PORT 1/2
EXT TRIGGER	input for external trigger signal
LEVEL	input for external level control
DC MEAS INPUTS DC 1/2	DC measurement inputs
EXT FREQ REF IN	input for external reference frequency
EXT FREQ REF OUT	output of internal reference frequency
EXTERNAL GENERATOR	Connectors for high-speed control of an external generator from Rohde & Schwarz families
BLANK (input)	TTL signal
TRIGGER (output)	TTL signal
ANALYZER MONITOR	IBM-PC-compatible VGA connector for analyzer screen
PC Monitor	IBM-PC-compatible VGA connector for PC screen
Mouse	IBM-PC-compatible PS/2 connector

Keyboard	IBM-PC-compatible 5-contact DIN connector
USER (input/output)	16 bit TTL, user-programmable, 25-contact sub-D
COM 1/COM 2	IBM-PC-compatible serial interfaces, RS-232-C, 9-contact sub-D
IEC/IEEE BUS	remote-control interface IEEE488, IEC625, 24-contact (for general applications)
IEC system bus	remote-control interface IEEE488, IEC625, 24-contact (for control of generators, e.g. as local oscillators in mixer measurements)
LPT	IBM-PC-compatible printer interface, Centronics, 25-contact sub-D
MULTIPOINT	control of optional three-port and four-port adapters

## General data

Operating temperature range	5°C to 40°C
Power supply	100 V to 120 V (AC) with tolerance $\pm 10\%$ , 6 A, 50 Hz to 400 Hz with tolerance $-6\%$ and $+10\%$ or 200 V to 240 V (AC) with tolerance $\pm 10\%$ , 3 A, 50 Hz to 60 Hz with tolerance $-6\%$ and $+10\%$
Power consumption	280 W (standby: 10 W)
Dimensions (W × H × D)	435 mm × 281 mm × 584 mm
Weight	30 kg

## Options overview

Option	Type	Features and benefits
Time Domain	R&S®ZVR-B2	Localization of discontinuities, determination of reflection coefficients of discontinuities as a function of length/delay, supplementary function for calibration, tuning of filters, optimization of connectors, etc
Mixer Measurements	R&S®ZVR-B4	Easy converter and mixer measurements (conversion gain). Convenient measurements of amplifier and mixer products vs. frequency (spurious, harmonics, intermodulation products, etc)
Nonlinear Measurements	R&S®ZVR-B5	Display of compression point and SOI/TOI versus frequency
Power Calibration	R&S®ZVR-B7	High absolute power accuracy of generators (internal and external) and receivers for amplifier and mixer measurements
Virtual Embedding Networks	R&S®ZVR-K9	Replacing various test fixtures with physical matching networks by one single standard fixture and virtual networks. High accuracy and reproducibility, e.g. in SAW filter measurements
Ethernet Interface for internal PC	R&S®FSE-B16	Control and data transfer of R&S®ZVM or R&S®ZVK via Ethernet
IEC/IEEE bus Interface for internal PC	R&S®FSE-B17	Control of R&S®ZVM or R&S®ZVK and external test equipment by internal PC
Generator Step Attenuator PORT 1	R&S®ZVM-B21, R&S®ZVK-B21	Decrease of minimum generator output power down to $-90$ dBm at PORT 1
Generator Step Attenuator PORT 2	R&S®ZVM-B22, R&S®ZVK-B22	Decrease of minimum generator output power down to $-90$ dBm at PORT 2
Receiver Step Attenuator PORT 1	R&S®ZVM-B23, R&S®ZVK-B23	Increase of maximum receiver input power at PORT 1 to $+27$ dBm Direct access to measurement channel b1
Receiver Step Attenuator PORT 2	R&S®ZVM-B24, R&S®ZVK-B24	Increase of maximum receiver input power at PORT 2 to $+27$ dBm Direct access to measurement channel b22



Contents Overview

Chapter Overview

Type Index

R&amp;S Addresses





Contents Overview

Chapter Overview

Type Index

R&amp;S Addresses



## Vector Network Analyzers R&amp;S®ZVM, R&amp;S®ZVK

## Ordering information

Order designation	Type	Frequency range	Order No.
<b>Vector Network Analyzer</b>			
4-channel, 50 Ω, active test set	R&S®ZVM	10 MHz to 20 GHz	1127.8500.60
	R&S®ZVK	10 MHz to 40 GHz	1127.8651.60
<b>Options</b>			
Time Domain	R&S®ZVR-B2	–	1044.1009.02
Mixer Measurements <sup>1)</sup>	R&S®ZVR-B4	–	1044.1215.02
Nonlinear Measurements	R&S®ZVR-B5	–	1044.1321.02
Power Calibration <sup>2)</sup>	R&S®ZVR-B7	–	1044.1544.02
Virtual Embedding Networks <sup>3)</sup>	R&S®ZVR-K9	–	1106.8830.02
Ethernet AUI for int. PC	R&S®FSE-B16	–	1073.5973.02
Ethernet BNC for int. PC	R&S®FSE-B16	–	1073.5973.03
Ethernet RJ-45 for int. PC	R&S®FSE-B16	–	1073.5973.04
IEC/IEEE bus Interface for internal PC	R&S®FSE-B17	–	1066.4017.02
Generator Step Attenuator for R&S®ZVM, PORT 1	R&S®ZVM-B21	–	1128.1009.11
Generator Step Attenuator for R&S®ZVM, PORT 2	R&S®ZVM-B22	–	1128.1009.21
Receiver Step Attenuator for R&S®ZVM, PORT 1 <sup>4)</sup>	R&S®ZVM-B23	–	1128.1009.12
Receiver Step Attenuator for R&S®ZVM, PORT 2 <sup>5)</sup>	R&S®ZVM-B24	–	1128.1009.22
Generator Step Attenuator for R&S®ZVK, PORT 1	R&S®ZVK-B21	–	1128.1409.11
Generator Step Attenuator for R&S®ZVK, PORT 2	R&S®ZVK-B22	–	1128.1409.21
Receiver Step Attenuator for R&S®ZVK, PORT 1 <sup>4)</sup>	R&S®ZVK-B23	–	1128.1409.12
Receiver Step Attenuator for R&S®ZVK, PORT 2 <sup>5)</sup>	R&S®ZVK-B24	–	1128.1409.22
<b>R&amp;S®ZVM, R&amp;S®ZVK accessories</b>			
<b>Test Cables (pairs)</b>			
PC3.5 (f)/PC3.5 (m), 50 Ω (for R&S®ZVM) <sup>6)</sup>	R&S®ZV-Z14	0 Hz to 26.5 GHz	1134.4093.02
2.92 mm (f)/2.92 mm (m), 50 Ω (for R&S®ZVK) <sup>6)</sup>	R&S®ZV-Z15	0 Hz to 40 GHz	1134.4193.02
<b>Calibration Kits</b>			
PC3.5 (for R&S®ZVM)	R&S®ZV-Z32	0 Hz to 26.5 GHz	1128.3501.02
PC3.5 incl. Sliding Matches (for R&S®ZVM)	R&S®ZV-Z33	0 Hz to 26.5 GHz	1128.3518.02
2.92 mm (for R&S®ZVK)	R&S®ZV-Z34	0 Hz to 40 GHz	1128.3530.02
2.92 mm incl. Sliding Matches (for R&S®ZVK)	R&S®ZV-Z35	0 Hz to 40 GHz	1128.3547.02
N, 50 Ω	R&S®ZV-Z21	0 Hz to 18 GHz	1085.7099.02
TRL Supplementary Kit, N, 50 Ω	R&S®ZV-Z26	0.4 GHz to 18 GHz	1085.7318.02
TRL Supplementary Kit, PC3.5, 50 Ω	R&S®ZV-Z27	0.4 GHz to 26.5 GHz	1085.7401.02
TOM-X Supplementary Kit, N, 50 Ω	R&S®ZV-Z28	0 Hz to 18 GHz	1085.7499.03
TOM-X Supplementary Kit, PC3.5, 50 Ω	R&S®ZV-Z29	4 GHz to 26.5 GHz	1085.7647.03

<b>Sliding Matches</b>			
N (m), 50 Ω	R&S®ZV-Z41	1.7 GHz to 18 GHz	1085.8095.02
N (f), 50 Ω	R&S®ZV-Z41	1.7 GHz to 18 GHz	1085.8095.03
PC3.5 pair m, f (for ZVM)	R&S®ZV-Z42	0 Hz to 26.5 GHz	1128.3524.02
2.92 mm pair m, f (for ZVK)	R&S®ZV-Z44	0 Hz to 40 GHz	1128.3553.02

**General accessories****Hardware Options N, 50 Ω**

AutoKal <sup>7)</sup>	R&S®ZVR-B1	0 Hz to 8 GHz	1044.0625.02
3-Port Adapter <sup>7)</sup>	R&S®ZVR-B8	0 Hz to 4 GHz	1086.0000.02
4-Port Adapter (2 × SPDT) <sup>7)</sup>	R&S®ZVR-B14	0 Hz to 4 GHz	1106.7510.02
4-Port Adapter (SP3T) <sup>7)</sup>	R&S®ZVR-B14	0 Hz to 4 GHz	1106.7510.03
<b>Test Cables (pairs)</b>			
N (m)/N (m), 50 Ω	R&S®ZV-Z11	0 Hz to 18 GHz	1085.6505.03
N (m)/N (m), 75 Ω	R&S®ZV-Z12	0 Hz to 4 GHz	1085.6570.02
N (m)/PC3.5 (m), 50 Ω	R&S®ZV-Z13	0 Hz to 18 GHz	1134.3997.02

**Calibration Kits**

N, 50 Ω	R&S®ZCAN	0 Hz to 3 GHz	0800.8515.52
N, 75 Ω	R&S®ZCAN	0 Hz to 3 GHz	0800.8515.72

**Attenuators**

1 W	R&S®DNF	0 Hz to 12.4 GHz	0272.4x10.50 <sup>9)</sup>
50 W	R&S®RBU 50	0 Hz to 2 GHz	1073.8695.xx <sup>9)</sup>
100 W	R&S®RBU 100	0 Hz to 2 GHz	1073.8495.xx <sup>9)</sup>

**Matching Pads, N, 50 Ω → N, 75 Ω**

Series Resistor	R&S®RAZ	0 Hz to 2.7 GHz	0358.5714.02
L Section	R&S®RAM	0 Hz to 2.7 GHz	0358.5414.02

**Various Accessories, N, 50 Ω**

T Check	R&S®ZV-Z60	0 Hz to 4 GHz	1108.4990.50
Bias Network	R&S®ZV-Z61	2 MHz to 4 GHz	1106.8130.02
DC Block	R&S®FSE-Z3	5 MHz to 7 GHz	4010.3895.00
Power Splitter 2 × 50 Ω	R&S®RVZ	0 Hz to 2.7 GHz	0800.6612.52

**External SWR-Bridges**

N (f), 50 Ω	R&S®ZRA	40 kHz to 150 MHz	1052.3607.52
N (f), 50 Ω	R&S®ZRB2	5 MHz to 3 GHz	0373.9017.52
N (f), 75 Ω	R&S®ZRB2	5 MHz to 2 GHz	0802.1018.73
N (f), 50 Ω	R&S®ZRC	40 kHz to 4 GHz	1039.9492.52
N (f), 75 Ω	R&S®ZRC	40 kHz to 2.5 GHz	1039.9492.72

**Miscellaneous**

Transit Case	R&S®ZZK-965	–	1013.9437.00
19"-Rack Adapter with front handles	R&S®ZZA-96	–	0396.4928.00

- 1) Harmonics and arbitrary frequency conversion measurement included.
- 2) Power meter and sensor required.
- 3) Only for R&S®ZVR, R&S®ZVC, R&S®ZVM, R&S®ZVK.
- 4) Comprises test port 'Input b1', for bypassing coupler at PORT 1.
- 5) Comprises test port 'Input b2', for bypassing coupler at PORT 2.
- 6) For ruggedized port.
- 7) Two adapters PC 3.5 (f)/N (f) or 2.92 mm (f)/N (f) required.
- 8) x = 0: 3 dB, x = 1: 6 dB, x = 2: 10 dB, x = 3: 20 dB, x = 4: 30 dB.
- 9) xx = 03: 3 dB, xx = 06: 6 dB, xx = 10: 10 dB, xx = 20: 20 dB, xx = 30: 30 dB.



Contents Overview

Chapter Overview

Type Index

R&amp;S Addresses



## SWR Bridges R&S® ZRA, R&S® ZRB2, R&S® ZRC, R&S® VCA-Z1

**Measurement of reflection coefficient of RF circuits and components**

- R&S® ZRA:** 40 kHz to 150 MHz
- R&S® ZRB2:** 5 MHz to 3 GHz
- R&S® ZRC:** 40 kHz to 4 GHz
- R&S® VCA-Z1:** 5 MHz to 850 MHz



SWR Bridge R&S® ZRC with calibration standards

### Brief description

SWR bridges are used for measuring the reflection coefficient of RF circuits and components. The output signal from the signal generator, e.g. the tracking gener-

ator of Spectrum Analyzer FSx or one Network Analyzer R&S® ZVx is applied to the device under test via the SWR bridge. Depending on the reflection coefficient of the device under test, part of the signal is reflected to the bridge and then routed to

the receiver, e.g. to the test input of FSx or in the case of external test sets to the additional test input "Input b2" or "Input b1", where it is detected and displayed.

### Measurement accuracy

The accuracy of the bridge is limited by its directivity as well as by the SWR of the bridge at the test port. The measurement of small reflection coefficients is affected by the finite directivity. Reflection coefficients that are smaller than the directivity cannot be measured directly. In measurements of large reflection coefficients, the accuracy depends primarily on the matching at the test port.

The diagram shown allows a quantitative evaluation of the measurement accuracy.

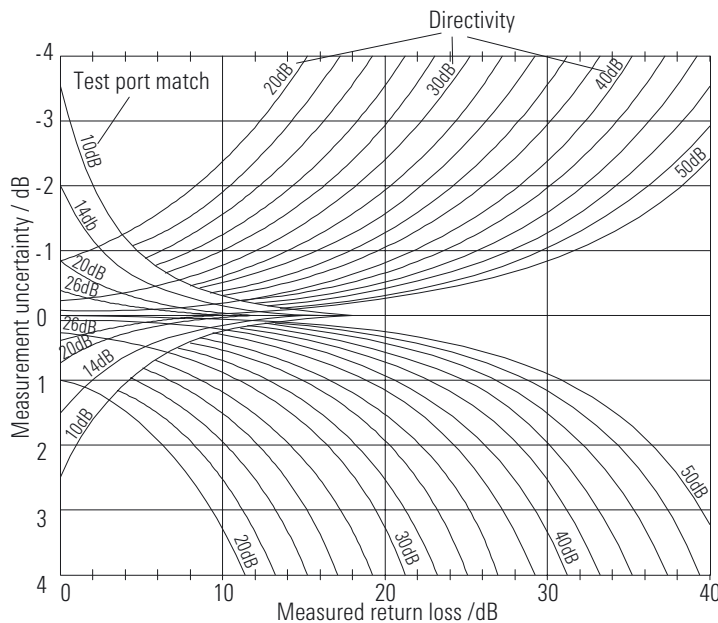

Measurement uncertainties as a function of directivity and test port matching of the bridge



Contents Overview

Chapter Overview

Type Index

R&amp;S Addresses



## SWR Bridges R&amp;S®ZRA, R&amp;S®ZRB2, R&amp;S®ZRC, R&amp;S®VCA-Z1

## Specifications in brief, ordering information

Designation	R&S®ZRA	R&S®ZRB2	R&S®ZRB2 (precision)	R&S®ZRB2
Impedance	50 Ω	50 Ω	50 Ω	75 Ω
Frequency range	40 kHz to 150 MHz	5 MHz to 2.5 GHz	5 MHz to 3 GHz	5 MHz to 2 GHz
Directivity	≥45 dB (up to 1 MHz) ≥40 dB (up to 150 MHz)	≥40 dB	≥46 dB (up to 2 GHz) ≥40 dB (up to 2.5 GHz) ≥34 dB (up to 3 GHz)	≥40 dB
Test port matching	≥20 dB (up to 200 kHz) ≥30 dB (0.2 MHz to 50 MHz) ≥20 dB (up to 150 MHz)	≥23 dB	≥26 dB (up to 2.5 GHz) ≥22 dB (up to 3 GHz)	≥20 dB (up to 1.5 GHz)
Insertion loss <sup>1)</sup>	7.5 dB + 6 dB	7 dB + 6 dB	7 dB + 6 dB	8 dB + 6 dB
Power-handling capacity	0.5 W	0.5 W	0.5 W	0.5 W
Test port connector	N female	N female, N male	N female, N male	N female
Accessories supplied	–	–	–	–
Rated temperature range	0°C to +50°C	0°C to +50°C	0°C to +50°C	0°C to +50°C
Storage temperature range	–40°C to +70°C	–40°C to +70°C	–40°C to +70°C	–40°C to +70°C
Connectors <sup>2)</sup>	N female	N female	N female	N female
Weight	240 g	240 g	240 g	250 g
Dimensions <sup>3)</sup>	72 mm × 57 mm × 33 mm	72 mm × 57 mm × 20 mm	72 mm × 57 mm × 20 mm	72 mm × 57 mm × 22 mm
<b>Order numbers</b>	1052.3607.52	373.9017.53 373.9017.56	373.9017.52 373.9017.55	802.1018.73

Designation	R&S®ZRC	R&S®ZRC	R&S®VCA-Z1
Impedance	50 Ω	75 Ω	75 Ω
Frequency range	40 kHz to 4 GHz	40 kHz to 2.5 GHz	5 MHz to 850 MHz
Directivity	≥40 dB (up to 3 GHz)	≥40 dB	≥40 dB (up to 300 MHz) ≥34 dB (up to 850 MHz)
Test port matching	≥12 dB + 11 dB log (f/40 kHz) (up to 400 kHz) ≥23 dB (up to 3 GHz) ≥20 dB (3 GHz to 4 GHz)	≥8 dB + 12 dB log (f/40 kHz) (up to 400 kHz) ≥20 dB (400 kHz to 2.5 GHz)	≥20 dB
Insertion loss <sup>1)</sup>	7 dB + 6 dB	7 dB + 6 dB	8 dB + 5 dB
Power-handling capacity	0.5 W	0.5 W	0.5 W
Test port connector	N female, N male	N female, N male	BNC male
Accessories supplied	short/open, termination, connector adapter	short/open, termination, connector adapter	–
Rated temperature range	0°C to +50°C	0°C to +50°C	0°C to +50°C
Storage temperature range	–40°C to +70°C	–40°C to +70°C	–40°C to +70°C
Connectors <sup>2)</sup>	N female	N female	BNC female
Weight	340 g	340 g	250 g
Dimensions <sup>3)</sup>	72 mm × 77 mm × 24 mm	72 mm × 77 mm × 24 mm	72 mm × 57 mm × 22 mm
<b>Order numbers</b>	1039.9492.52 1039.9492.55	1039.9492.72 1039.9492.75	1052.5900.02

1) Input attenuation ----> test port + test port ---> output.

2) Input, output.

3) In mm without connectors.



Contents Overview

Chapter Overview

Type Index

R&amp;S Addresses





Contents Overview

Chapter Overview

Type Index

R&S Addresses

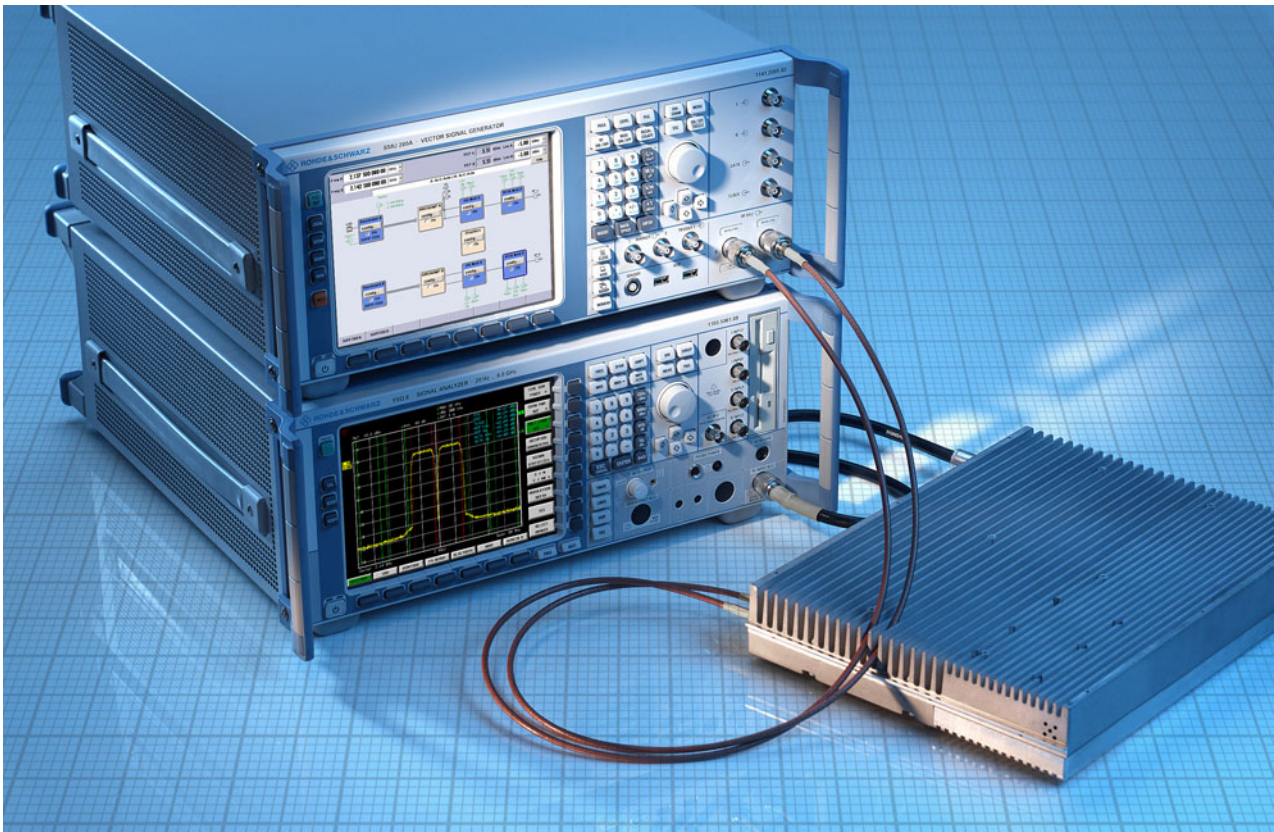

*New approaches in generation and analysis of complex I/Q Signals with Vector Signal Generator R&S® SMU200A and Signal Analyzer R&S® FSQ8*



Contents Overview

Chapter Overview

Type Index

R&S Addresses







Contents Overview

Chapter Overview

Type Index

R&amp;S Addresses



## Contents of Chapter 5

Designation	Type	Description	Page
<b>Vector Signal Generators</b>			
100 kHz to 6 GHz	R&S®SMU200A	Two independent signal generators in one cabinet with unrivalled RF and baseband characteristics	226
300 kHz to 2.2 GHz 300 kHz to 3.3 GHz 300 kHz to 4.4 GHz 300 kHz to 6.4 GHz 300 kHz to 3.3 GHz	R&S®SMIQ02B R&S®SMIQ03B R&S®SMIQ04B R&S®SMIQ06B R&S®SMIQ03HD	Signal Generator Family for analog and digital modulation is offering solutions for today and tomorrow. This series particularly takes into account future developments in the field of 3rd-generation digital mobile radio.  Dedicated to 3GPP, special model of Vector Signal Generator R&S®SMIQ	232  238
9 kHz to 3.3 GHz	R&S®SMV03	Based on the analog Signal Generator R&S®SML03. It comprises an additional broadband I/Q modulator which is able to generate any digital signal in conjunction with an external I/Q source	240
<b>RF Signal Generators</b>			
5 kHz to 1.5 GHz 5 kHz to 3 GHz 5 kHz to 6 GHz	R&S®SMT02 R&S®SMT03 R&S®SMT06	For all fields of analog receiver measurements as well as EMS applications Same as R&S®SMT02, but enhanced frequency range Same as R&S®SMT02, but enhanced frequency range	244
9 kHz to 1.1 GHz 9 kHz to 2.2 GHz 9 kHz to 3.3 GHz	R&S®SML01 R&S®SML02 R&S®SML03	Offers all features required of a state-of-the-art general-purpose signal generator: wide frequency range, large variety of modulation functions and high reliability – at an extremely attractive price.	246
9 kHz to 3 GHz	R&S®SM300	Professional signal generator for production, laboratory and service	249
<b>Microwave Signal Generators</b>			
0.01/2 GHz to 20 GHz 0.01/2 GHz to 20 GHz 0.01/2 GHz to 27 GHz 0.01/2 GHz to 40 GHz	R&S®SMP02 R&S®SMP22 R&S®SMP03 R&S®SMP04	A reliable, high-precision signal source featuring high output power, high spectral purity and excellent pulse modulation. It is able to supply signals for any measurements on radar and communications receivers.	251
1 GHz to 20 GHz 1 GHz to 27 GHz 1 GHz to 30 GHz 1 GHz to 40 GHz 1 GHz to 50 GHz 1 GHz to 60 GHz	R&S®SMR20 R&S®SMR27 R&S®SMR30 R&S®SMR40 R&S®SMR50 R&S®SMR60	The R&S®SMR family comprises four basic models designed as CW generators with pulse modulation capability. Offering an excellent price/performance ratio, each of the four basic models is ideal for the user wishing to enter the field of microwave testing at an affordable price.  High-performance, cost-effective and reliable up to 60 GHz	255  258
<b>Function and ARB Generators</b>			
14 (16) bit, 16 Msample	R&S®AMIQ04	Dual-channel modulation generator that has consequently been designed for use as an I/Q source. It is programmed and set with Software R&S®WinIQSIM™. Alternatively, R&S®AMIQ can be operated from a Vector Signal Generator R&S®SMIQ	261
DC up to 50 MHz 100 Msample/s	R&S®AM300	Dual-channel arbitrary/function generator that offers superb functionality and spectral purity at a favourable price	266
<b>Simulation Software</b>	R&S®WinIQSIM™	Ideal for the generation of digitally modulated signals	263
<b>Baseband Fading Simulator</b>	R&S®ABFS	Saving costs through real-world fading tests	268



Contents Overview

Chapter Overview

Type Index

R&amp;S Addresses



## Vector Signal Generator R&amp;S®SMU200A

New

**Up to two independent signal generators in one cabinet with unrivalled RF and baseband characteristics**

*Vector Signal Generator R&S®SMU200A with 6 GHz RF path A and 3 GHz RF path B and fading simulator*

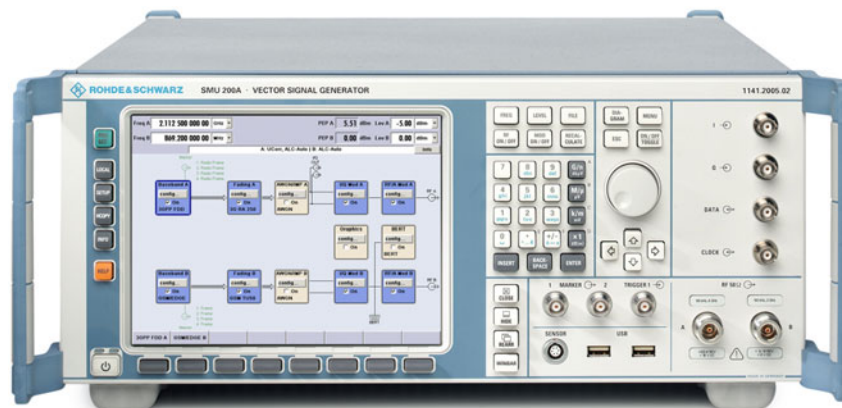

## Brief description

The Vector Signal Generator R&S®SMU200A has been designed to meet all requirements encountered in research and development of modern communication systems as well as in their production. The R&S®SMU200A not only combines up to two independent signal generators in one cabinet of only four height units, it also offers unrivalled RF and baseband characteristics.

Due to its modular design, the R&S®SMU200A can be optimally adapted to the requirements of different applications. The first RF path can be equipped with one of the four available frequency options. The upper frequency limit of 2.2/3/4 GHz or 6 GHz is user-

selectable. In addition a second RF path can be installed with upper frequency limits of 2.2 GHz and 3 GHz. The lower frequency limit of all frequency options is 100 kHz.

Up to two generators can also be installed in the baseband section. They generate complex signals in realtime and are equipped with an arbitrary waveform generator with 56 Msample memory for

I and Q and 4 marker bits per sample (256 Mbyte). The signals generated in the different basebands can be added even with frequency offset.

The modern, intuitive concept of the R&S®SMU200A ensures fast and easy operation.

## Main features

**Two signal generators in one**

- ◆ Frequency options from 100 kHz to 2.2/3/4/6 GHz for the first RF path
- ◆ Optional second RF path up to 2.2 GHz or 3 GHz
- ◆ Up to two complete baseband paths
- ◆ Lossless combination of baseband signals in the digital domain (e.g. for testing multistandard base stations)

**Outstanding signal quality**

- ◆ I/Q modulator with 200 MHz RF bandwidth
- ◆ Very low SSB phase noise of typ.  $-135$  dBc ( $f = 1$  GHz, 20 kHz carrier offset, 1 Hz measurement bandwidth)
- ◆ Wideband noise of typ.  $-153$  dBc (CW,  $f = 1$  GHz,  $>5$  MHz carrier offset, 1 Hz measurement bandwidth)
- ◆ Excellent ACLR of typically  $+70$  dB for 3GPP FDD (test model 1, 64 DPCH)
- ◆ Very high level repeatability of 0.05 dB
- ◆ High output power up to  $+19$  dBm (PEP), overrange  $+26$  dBm
- ◆ High-stability reference oscillator as standard

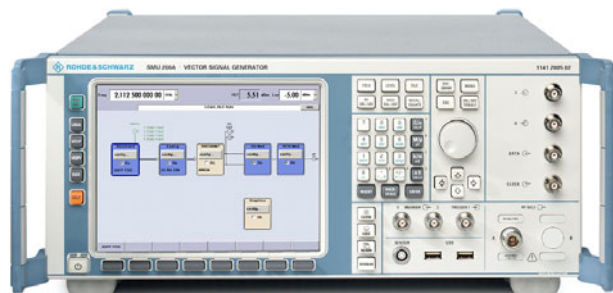

*Vector Signal Generator R&S®SMU200A equipped with only one RF path*



Contents Overview

Chapter Overview

Type Index

R&S Addresses



## Vector Signal Generator R&S®SMU200A

### Unrivalled flexibility

- ◆ Four code channels in realtime for 3GPP
- ◆ Eight code channels in real time for cdma2000
- ◆ Change of modulation from slot to slot for GSM/EDGE
- ◆ Baseband generator with universal coder for realtime signal generation
- ◆ Arbitrary waveform generator with 56 Msample for I and Q and 4 marker bits per sample (256 Mbyte)
- ◆ Arbitrary waveform generator supported by Simulation Software R&S®WinIQSIM™
- ◆ Internal hard disk provided as standard for storing waveforms and modulation data
- ◆ Fading simulator with up to 40 paths

### Intuitive operation

- ◆ Colour display with 800 × 600 pixels (SVGA format)
- ◆ Intuitive user interface with graphical display of signal flow
- ◆ Graphical display of baseband signals through built-in transient recorder
- ◆ Context-sensitive help system

### Ideal for production

- ◆ Very short frequency setting times (<3 ms); only 450 μs in List mode
- ◆ Electronic attenuator up to 6 GHz
- ◆ Minimum space required as two complete generators are accommodated in one cabinet of only four height units

### Connectivity

- ◆ Can be remote-controlled via GPIB and LAN
- ◆ USB connectors for keyboard, mouse and memory stick
- ◆ User-selectable trigger and marker signals

### Characteristics

#### Intuitive operation

The R&S®SMU200A is equipped with a modern and intuitive user interface. The signal flow from the baseband to the RF output is clearly shown in the block diagram. Each block represents a functional unit of the instrument. The generated signal can be seen at a glance, and whether it is affected by additive white Gaussian noise or other impairments.

The baseband signal can be monitored in the graphics block. For instance, the vector or constellation diagram, the I/Q characteristic or the output spectrum of a signal can be displayed, making

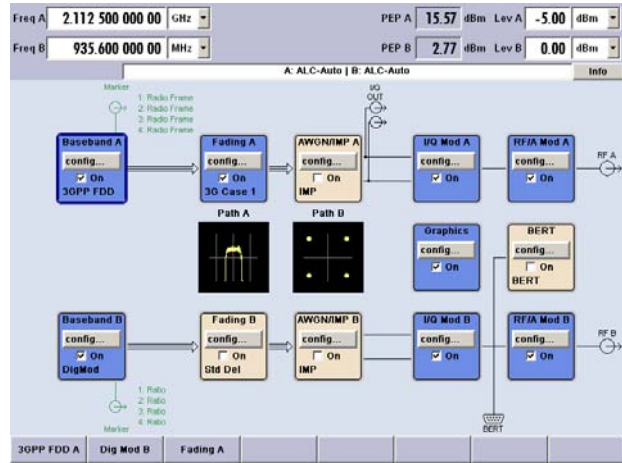

Block diagram of the R&S®SMU200A (2 paths)

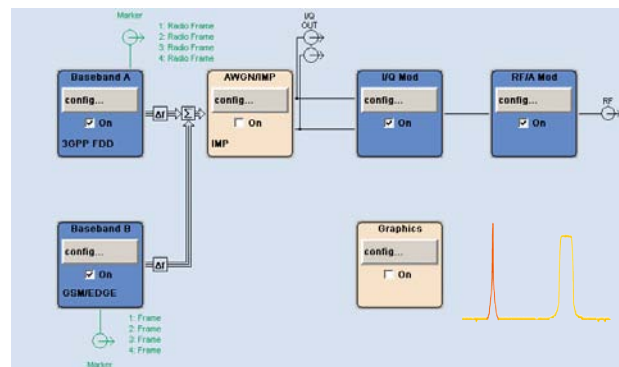

Generation of 3GPP and GSM/EDGE signals in realtime

it possible to check whether the generated signal corresponds to the required signal. This is of great help particularly when complex signals are produced.

Another outstanding feature of the R&S SMU200A is its context-sensitive online help. If the exact function of a parameter is not known, simply pushing the help key instantaneously displays a help text with information about the selected parameter. Further information can be obtained through navigation with a browser-like system. The help system also specifies the relevant remote-control commands. Full-text searching in the help system, which contains the complete operating manual, comes in handy when complex measurement tasks are to be performed. Tool tips are provided in addition. If you pause on a parameter, the currently permissible setting range is displayed.



Contents Overview

Chapter Overview

Type Index

R&S Addresses





Contents Overview

Chapter Overview

Type Index

R&S Addresses



## Vector Signal Generator R&S®SMU200A

### Outstanding signal quality

Owing to the sophisticated multiloop synthesizer concept, the R&S®SMU200A features extremely low SSB phase noise and wideband noise. A high-stability ovencontrolled reference oscillator is installed as standard, which provides excellent aging characteristics as well as minimum temperature drift. The R&S®SMU200A is ideal, for instance, for LO or VCO substitution.

Amplifiers of 3GPP base stations require very good adjacent channel leakage ratio (ACLR) performance in order not to impair the adjacent channels of the transmission. To test this feature, the ACLR characteristics of the signal generator must be better than those of the amplifier. Presently, multicarrier power amplifiers are increasingly used. In this case, not only one but several neighbouring signals in the frequency range are amplified. Testing such amplifiers places even higher demands on signal generator capabilities. The outstanding ACLR characteristics of the R&S®SMU200A more than qualify the generator for this task.

When external I/Q signals are applied, the R&S®SMU200A features an RF bandwidth of 200 MHz. If the internal baseband is used, an RF bandwidth of 80 MHz is available, which is ideal for testing multicarrier amplifiers. The R&S®SMU200A is thus well prepared for future broadband systems.

The R&S®SMU200A offers highly accurate output power of up to +13 dBm (PEP). A wear-and-tear-free electronic attenuator is used in the full level range. With the aid of the "high-power output" option, the output power can be increased to +26 dBm (PEP) in the overrange.

Digital ALC implemented in the R&S®SMU200A together with a detector operating at constant temperature ensures high level linearity and repeatability. ALC may be on for most kinds of complex signal scenarios.

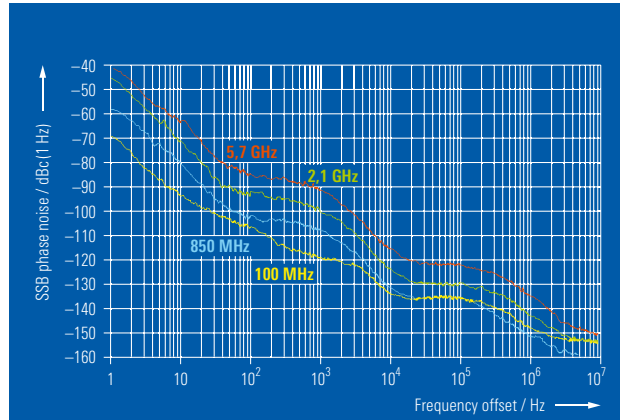

Typical SSB phase noise at 100 MHz, 850 MHz, 2.1 GHz and 5.7 GHz

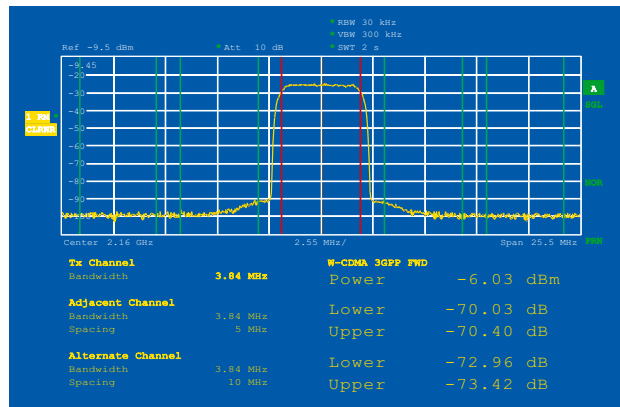

Outstanding ACLR characteristics

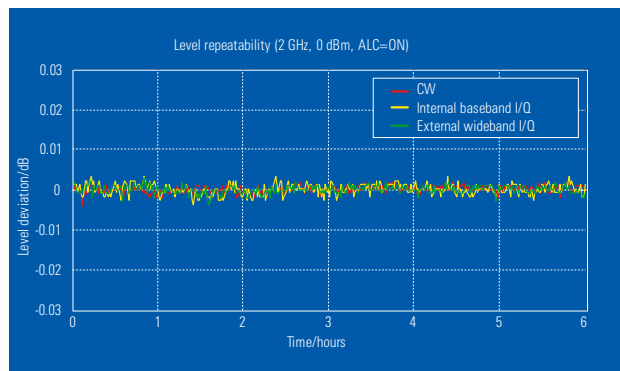

High level repeatability of the R&S®SMU200



Contents Overview

Chapter Overview

Type Index

R&S Addresses



## Vector Signal Generator R&S®SMU200A

### Unrivalled flexibility

The standards of the third mobile radio generation set considerably higher demands on signal generator functionality. Because of their good RF characteristics and their flexibility, signal generators are the instrument of choice particularly when base stations are tested. The universal coder in the baseband generator of the R&S®SMU200A has been designed for easy implementation of new standards. The R&S®SMU200A is therefore well prepared for present and future mobile radio standards.

All the strengths of the two-path concept of the R&S®SMU200A become specially evident in the field of mobile radio. Since the baseband section of the R&S®SMU200A is fully digital, the signals of the two baseband generators can be easily added without synchronization problems and without an external coupler or additional equipment being required. A frequency offset and the relative power of each signal can be accurately set.

### Fading

The R&S®SMU200A permits baseband signal fading in realtime. If all options are installed, up to 40 fading paths are available for a fader, or 20 fading paths each for dual-channel fading. Both channels can be connected differently for the various test scenarios. For example, frequency diversity can be simulated with the same input signals and two separate output signals. Or, network handover can be simulated with separate input signals that are added together after fading.

A comprehensive scope of default settings in accordance with the test specifications of the main mobile radio standards (3GPP test scenarios included) facilitate the use of the R&S®SMU200A in the research, development and quality control of mobile radios. All parameters of the available fading configurations are user-definable for more detailed tests.

### Remote control

The R&S®SMU200A is remote-controlled via GPIB or LAN. When the Windows Remote Desktop is used, the instrument can be remote-operated from a PC.

### Convenient service

"Low cost of ownership" is more than just a motto – it is a fully fledged concept. The three-year calibration cycle considerably reduces costs.

Realtime channels

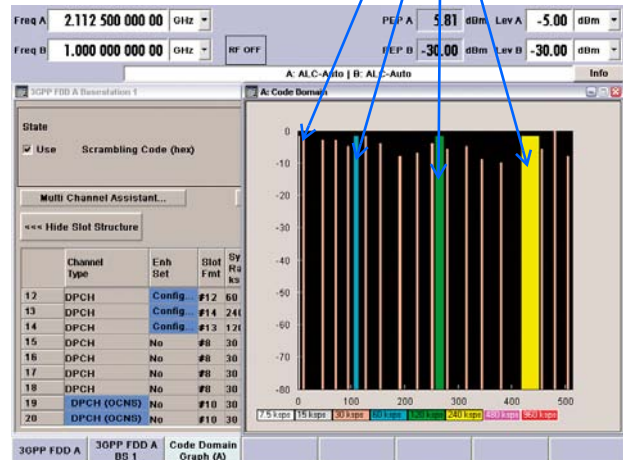

Four code channels in realtime with additional background channels

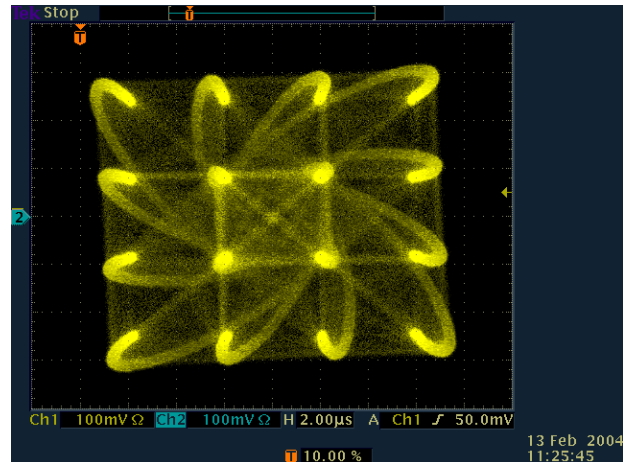

16QAM faded by a Rayleigh channel

A thermal management with oversized fans combined with large-scale integration ensures high reliability even under adverse environmental conditions.

Rohde&Schwarz Service Centers all over the world reduce transit times in the case of repair and ensure short turnaround times.



Contents Overview

Chapter Overview

Type Index

R&amp;S Addresses



## Vector Signal Generator R&amp;S®SMU200A

## Specifications in brief

You will find detailed and binding data on the enclosed CD

(./DATASHEET/SMU200A.pdf), or, for the latest updates, visit [www.rohde-schwarz.com](http://www.rohde-schwarz.com), search term: SMU200A

<b>Frequency</b>		
Frequency range	depending on frequency options	100 kHz to 2.2/3/4/6 GHz
Setting time	To within $<1 \times 10^{-7}$ for $f > 200$ MHz or $<124$ Hz for $f < 200$ MHz after IEC/IEEE bus delimiter	$<3$ ms
Setting time in List mode	after trigger pulse in List mode	$<450$ $\mu$ s
<b>Sweep</b>	Operating modes	digital sweep in discrete steps automatic, single shot, manual or external trigger, linear or logarithmic
<b>Level</b>		
Range	PEP, 3 GHz with high-power output option	-145 dBm to +13 dBm -145 dBm to +19 dBm
Accuracy	Levels $>120$ dBm, attenuator mode "auto", temperature range 18°C to 33°C, $f \leq 3$ GHz	$<0.5$ dB
<b>Spectral purity</b>		
Nonharmonics	$>850$ kHz offset from carrier and outside the modulation spectrum, $200 \text{ MHz} < f \leq 1500 \text{ MHz}$	$<-86$ dBc
Wideband noise	Carrier offset $>5$ MHz, measurement bandwidth 1 Hz, CW, $200 \text{ MHz} < f \leq 3 \text{ GHz}$	typ. -153 dBc
SSB phase noise	Carrier offset 20 kHz, measurement bandwidth 1 Hz, unmodulated, $20 \text{ MHz} \leq f \leq 200 \text{ MHz}$ , $f = 1 \text{ GHz}$	typ. -135 dBc
<b>ACLR</b>		
3GPP test model 1, 64 DPCH		typ. 70 dB
RF modulation bandwidth	using external I/Q inputs using internal baseband section	200 MHz 80 MHz
<b>Supported modulation types</b>		
AM		DC to 500 kHz
Pulse		0 Hz to 100 kHz
ASK		0% to 100%
FSK		MSK, 2FSK, 4FSK
PSK		BPSK, QPSK, OQPSK, $\pi/2$ DBPSK, $\pi/4$ DQPSK, $\pi/8$ D8PSK, $\pi/4$ QPSK, 8PSK, 8PSK EDGE
QAM		16QAM, 32QAM, 64QAM, 256QAM, 1024QAM
<b>Supported standards and digital systems</b>		GSM/EDGE, 3GPP FDD, 3GPP TDD, TD-SCDMA, cdmaOne, cdma2000, 1xEV-DO, IEEE 802.11a, IEEE 802.11b, IEEE 802.11g, TETRA, <i>Bluetooth</i> , AWGN, user-defined multicarrier CW
<b>General data</b>		
Interfaces		IEEE488.2, LAN (100BaseT), 3 $\times$ USB, 1 $\times$ USB slave, VGA
Power supply		100 V AC to 240 V AC, 47 Hz to 63 Hz
Operating temperature range		5°C to 45°C
Dimensions (W $\times$ H $\times$ D)		435 mm $\times$ 192 mm $\times$ 460 mm
Weight (fully equipped)		25 kg



Contents Overview

Chapter Overview

Type Index

R&amp;S Addresses





## Vector Signal Generator R&S®SMU200A

### Ordering information

Designation	Remarks	Type	Order No.
<b>Vector Signal Generator<sup>1)</sup></b>	Basic unit, requires frequency option for path A	R&S®SMU200A	1141.2005.02
including power cable, Quick Start Guide and CD-ROM (with operating and service manual)			
<b>Options</b>			
RF Path A			
100 kHz to 2.2 GHz	factory fitted only	R&S®SMU-B102	1141.8503.02
100 kHz to 3 GHz	factory fitted only	R&S®SMU-B103	1141.8603.02
100 kHz to 4 GHz	factory fitted only	R&S®SMU-B104	1141.8703.02
100 kHz to 6 GHz	factory fitted only	R&S®SMU-B106	1141.8803.02
Overvoltage Protection	factory fitted only	R&S®SMU-B30	1159.7444.02
High-Power Output	factory fitted only	R&S®SMU-B31	1159.8011.02
Overvoltage Protection and High-Power Output	factory fitted only	R&S®SMU-B32	1160.0256.02
RF Path B			
100 kHz to 2.2 GHz	factory fitted only	R&S®SMU-B202	1141.9400.02
100 kHz to 3 GHz	factory fitted only	R&S®SMU-B203	1141.9500.02
Overvoltage Protection	factory fitted only	R&S®SMU-B35	1160.0633.02
High-Power Output	factory fitted only	R&S®SMU-B36	1160.1000.02
Overvoltage Protection and High-Power Output	factory fitted only	R&S®SMU-B37	1160.1400.02
Baseband			
Baseband Generator with ARB (56 Msample) and Digital Modulation (realtime)	factory fitted only	R&S®SMU-B10	1141.7007.02
Baseband Generator with ARB (12 Msample) and Digital Modulation (realtime)	factory fitted only	R&S®SMU-B11	1159.8411.02
Baseband Main Module	factory fitted only	R&S®SMU-B13	1141.8003.02
Digital modulation systems			
Digital Standard GSM/EDGE	R&S®SMU-B10 required	R&S®SMU-K40	1160.7609.02
Digital Standard 3GPP FDD	R&S®SMU-B10 required	R&S®SMU-K42	1160.7909.02
3GPP FDD Enhanced MS/BS Tests incl. HSDPA	R&S®SMU-B10 required	R&S®SMU-K43	1160.9660.02
Digital Standard cdma2000 incl 1xEV-DV	R&S®SMU-B10 required	R&S®SMU-K46	1160.9876.02
Multicarrier CW Signal Generation	R&S®SMU-B10 required	R&S®SMU-K61	1160.8505.02
Digital modulation systems using R&S®WinIQSIM™ <sup>2)</sup>			
Digital Standard IS-95	R&S®WinIQSIM™ and R&S®SMU-B10 required	R&S®SMU-K11	1160.5335.02
Digital Standard cdma2000	R&S®WinIQSIM™ and R&S®SMU-B10 required	R&S®SMU-K12	1160.5658.02
Digital Standard 3GPP TDD	R&S®WinIQSIM™ and R&S®SMU-B10 required	R&S®SMU-K13	1160.5906.02
Digital Standard TD-SCDMA	R&S®WinIQSIM™ and R&S®SMU-B10 required	R&S®SMU-K14	1160.6202.02
User-Defined OFDM Signals	R&S®WinIQSIM™ and R&S®SMU-B10 required	R&S®SMU-K15	1160.6402.02
Digital Standard 1xEV-DO	R&S®WinIQSIM™ and R&S®SMU-B10 required	R&S®SMU-K17	1160.7009.02
Digital Standard IEEE 802.11 (a/b/g)	R&S®WinIQSIM™ and R&S®SMU-B10 required	R&S®SMU-K19	1160.8805.02
Digital Standard 3GPP FDD incl HSDPA	R&S®WinIQSIM™ and R&S®SMU-B10 required	R&S®SMU-K20	1160.9460.02
Fading and noise			
Fading Simulator	expected to be available as from October 2004	R&S®SMU-B14	1160.1800.02
Fading Simulator Extension	expected to be available as from October 2004	R&S®SMU-B15	1160.2288.02
Additive White Gaussian Noise (AWGN)	R&S®SMU-B13 required	R&S®SMU-K62	1159.8511.02
Dynamic Fading and Enhanced Resolution	expected to be available as from October 2004	R&S®SMU-K71	1160.9201.02
Bit Error Rate Tester		R&S®SMU-K80	1159.8770.02
<b>Recommended extras</b>			
DKD Calibration incl. ISO 9000 Calibration	ordering with device only	R&S®SMU200DKD	1136.3536.02
Documentation of Calibration Values R&S®SMU200A		R&S®SMU-DCV	0240.2193.18
19" Rack Adapter		R&S®ZZA-411	1096.3283.00
Adapter for Telescopic Sliders		R&S®ZZA-T45	1109.3774.00
BNC Adapter Board for AUX I/O connector		R&S®SMU-Z5	1160.4545.02
Keyboard with USB Interface (US assignment)		R&S®PSL-Z2	1157.6870.03
Mouse with USB Interface, optical		R&S®PSL-Z10	1157.7060.02
External USB CD-RW Drive		R&S®PSP-B6	1134.8201.12

<sup>1)</sup> The base unit can only be ordered together with an R&S®SMU-B10x frequency option.

<sup>2)</sup> R&S®WinIQSIM™ requires an external PC.



## Vector Signal Generator R&S® SMIQ

**R&S® SMIQ02B/03B/04B/06B:**  
**300 kHz to 2.2/3.3/4.4/6.4 GHz**  
**Digital signals of your choice**

*Vector Signal Generator R&S® SMIQ03B*

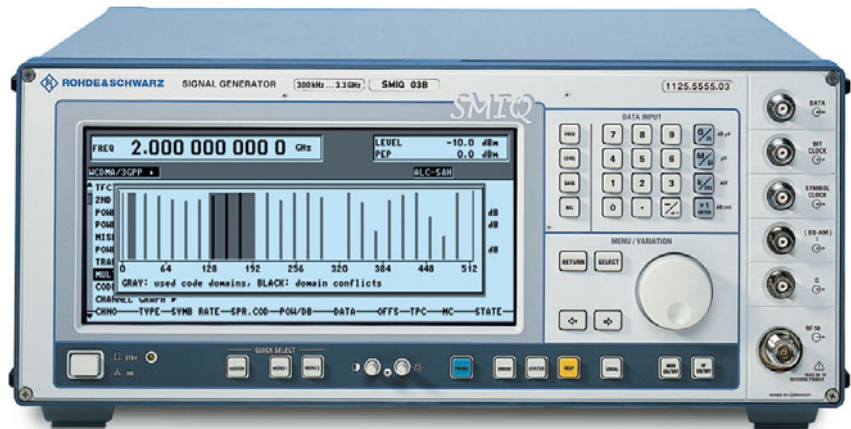

### Brief description

The B series of Signal Generator Family R&S® SMIQ for analog and digital modulation is offering solutions for today and tomorrow. This series particularly takes into account future developments in the field of 3rd-generation digital mobile radio.

The R&S® SMIQ family comprises four models which differ in their upper frequency limits. These feature a hitherto unrivalled versatility regarding signal generation and signal quality and are therefore ideal for use in development and type-approval testing.

With their outstanding price/performance ratio, these signal generators are also economically attractive for applications in production. The wide frequency range from 300 kHz to 6.4 GHz covers all main radio bands including their IF ranges.

The high-grade I/Q modulator fitted as standard ensures minimum error vector magnitude and high intermodulation suppression. Using modern digital signal processor (DSP) technology, the versatile concept allows the generation of high-precision digital modulation signals with

high bit rates without any limitations on modulation modes or standards.

In addition to digital modulation, the signal generators provide the full range of analog modulation modes as well as simultaneous modulation capability.

### Applications

- ◆ Type-approval testing of digital base and mobile stations
- ◆ Base-station transmitter test
- ◆ Sensitivity measurements on digital receivers
- ◆ Selectivity measurements on digital receivers
- ◆ Testing of equalizers
- ◆ Tolerance tests on digital systems
- ◆ Components tests
- ◆ Development of new digital communication systems

### Main features

- ◆ Frequency range 300 kHz to 2.2/3.3/4.4/6.4 GHz
- ◆ Analog and digital modulation
- ◆ Versatile and broadband generation of digitally modulated signals up to 18 Msymbol/s
- ◆ Generation of TDMA, CDMA, WCDMA and cdma2000 standard signals to all main mobile radio standards

- ◆ Broadband I/Q modulator with outstanding vector accuracy
- ◆ Optional internal fading simulator to test specifications of mobile radio standards
- ◆ Optional internal noise generator and distortion simulator
- ◆ Optional BER measurement
- ◆ Optional arbitrary waveform generator
- ◆ Low ACP for IS-95 CDMA and WCDMA (option)
- ◆ Low cost of ownership due to three-year calibration intervals
- ◆ Future-oriented platform concept
- ◆ Unrivalled price/performance ratio

### Characteristics

#### Digital modulation

Any digital modulation modes (with option R&S® SMIQB20)

- ◆ Free choice of modulation mode from ASK through to 256QAM
- ◆ Any kind of baseband filtering with variable filter parameters
- ◆ Symbol rate adjustable up to 18 Msymbol/s
- ◆ Realtime coding of internal and external data
- ◆ Internal PRBS generators





Contents Overview

Chapter Overview

Type Index

R&S Addresses



## R&S®SMIQ: Overview of options

Application <sup>1)</sup>	R&S®SM-B1	R&S®SM-B5	R&S®SMIQB11 <sup>2)</sup>	R&S®SMIQB12	R&S®SMIQB14	R&S®SMIQB15	R&S®SMIQB17	R&S®SMIQB20	R&S®SMIQB21	R&S®SMIQB42 <sup>3)</sup>	R&S®SMIQB43 <sup>3)</sup>	R&S®SMIQB45 <sup>3)</sup>	R&S®SMIQB47	R&S®SMIQB48	R&S®SMIQB49	R&S®SMIQB51 <sup>3)</sup>	R&S®SMIQB60	R&S®SMIQ-K5 <sup>3)</sup>	R&S®SMIQ-K8 <sup>3)</sup>	R&S®SMIQK11	R&S®SMIQK12	R&S®SMIQK13	R&S®SMIQK14	R&S®SMIQK15	R&S®SMIQK17	R&S®SMIQK19	R&S®SMIQK20	
Reference Oscillator OCXO																												
FM/φM Modulator																												
Data Generator (15 Mbit RAM)																												
Memory Extension, 32 Mbit																												
Fading Simulator (6 paths)																												
2nd Fading Simulator (6 paths)																												
Noise Generator and Distortion Simulator																												
Digital Modulation Coder																												
BER measurement																												
Digital Standard IS-95 CDMA																												
Digital Standard WCDMA (NTT DoCoMo 1.0, ARIB 0.0)																												
Digital Standard WCDMA according to 3GPP (FDD)																												
Low ACP for IS-95 CDMA and WCDMA																												
Extended Functions for WCDMA 3GPP																												
Extended Fading Functions for WCDMA 3GPP																												
Digital Standard IGPS																												
Arbitrary Waveform Generator																												
Digital Standard <i>Bluetooth</i>																												
Digital Standard TETRA																												
Digital Standard IS-95 CDMA (with ARB R&S®SMIQB60)																												
Digital Standard cdma2000 (with ARB R&S®SMIQB60)																												
Digital Std. WCDMA 3GPP TDD (with ARB R&S®SMIQB60)																												
Digital Standard TD-SCDMA (with ARB R&S®SMIQB60)																												
OFDM Signal Generation (with ARB R&S®SMIQB60)																												
Digital Standard 1xEV-DO (with ARB R&S®SMIQB60)																												
Digital Standard IEEE802.11 (with ARB R&S®SMIQB60)																												
Dig. Std. 3GPPFDDA incl. HSDPA (with ARB R&S®SMIQB60)																												

1) R&S®SMIQ2B/03B (R&S®SMIQ04B/06B) can be equipped with up to three (two) of the following options: R&S®SM-B5, R&S®SMIQB14, R&S®SMIQB15 or R&S®SMIQB17.  
 2) Option R&S®SMIQB20 required. ● = required  
 3) Options R&S®SMIQB20 and R&S®SMIQB11 required. ○ = optional



Contents Overview

Chapter Overview

Type Index

R&S Addresses





Contents Overview

Chapter Overview

Type Index

R&amp;S Addresses



## Vector Signal Generator R&S®SMIQ

Convenient burst generation for TDMA standards (with option R&S®SMIQB20/R&S®SMIQB11)

- ◆ TDMA mobile radio standards provided as standard GSM, GSM/EDGE, DECT, NADC (IS-54C/IS-136), PDC, PHS
- ◆ Versatile external synchronization capabilities
- ◆ Realtime processing of external and internal data
- ◆ Generation of TDMA frames with versatile timeslot configuration
- ◆ Continuous PRBS sequences
- ◆ Optimization of burst shaping to reduce spectra due to switching
- ◆ Realtime processing with external data for BER tests
- ◆ Fast Slot-by-slot modulation change at GSM/EDGE

### Analog modulation

- ◆ Broadband AM with up to 30 MHz modulation frequency
- ◆ I/Q modulation with 30 MHz modulation bandwidth (3 dB), 60 MHz RF bandwidth
- ◆ Unprecedented vector accuracy and high intermodulation suppression
- ◆ Amplitude modulation
- ◆ Pulse modulation
- ◆ Optional frequency and phase modulation (R&S®SM-B5)

### RF characteristics

- ◆ Wide output frequency range from 300 kHz to 6.4 GHz
- ◆ High (up to 16 dBm) and precise output level (<0.5 dB)
- ◆ Fast setting time for frequency (<3 ms) and level (<2.5 ms)<sup>1)</sup>
- ◆ Frequency hopping (500 μs)

- ◆ High spectral purity (typ. -130 dBc (1 Hz) at 1 GHz and 20 kHz carrier offset)
- ◆ Calibrated RF level in range from -140 dBm to -5 dBm
- ◆ RF, AF and level sweep (user-programmable)

### Special options

#### Fading Simulation R&S®SMIQB14/B15

- ◆ Fading of internal or external I/Q signals conforming to mobile radio standards
- ◆ 6-path simulation can be enhanced to 12-path simulation (2-channel fading also possible with second vector signal generator)
- ◆ Rayleigh, Rice and Lognormal fading profiles independently for each path selectable
- ◆ Selectable path attenuation and delay
- ◆ Simulation of high speeds
- ◆ Preprogrammed fading profiles for mobile radio standards GSM, NADC, IS-95 CDMA and TETRA
- ◆ Frequency range of basic unit can be fully utilized

#### Noise Generator and Distortion

##### Simulator R&S®SMIQB17

- ◆ Simulation of amplitude and phase distortion (AM/AM and AM/φM characteristics)
- ◆ Distortion characteristics programmable from up to 30 input values
- ◆ Superimposed noise signals (AWGN)
- ◆ C/N ratio variable with high resolution over a wide range
- ◆ Broad noise bandwidth (10 kHz to 10 MHz)

#### Bit Error Rate Measurements

##### R&S®SMIQB21

- ◆ Up to 30 MHz clock rate

#### WCDMA for 3GPP/FDD R&S®SMIQB45

Software option R&S®SMIQB45 supports the generation of downlink and uplink signals in line with the 3GPP standard (FDD mode). As the standardization process is not yet completed, the functionality of this option will continuously be adapted to the relevant standard modifications and expansions (for functionality see specifications).

#### Low ACP for IS-95 CDMA and WCDMA R&S®SMIQB47

- ◆ Specially designed for 1.2288 Mcps, 4.096 Mcps and 8.192 Mcps as well as 3.840 Mcps according to 3GPP
- ◆ Can be used with internal (option R&S®SMIQB42/43/45/48) or external CDMA/WCDMA signals
- ◆ Typical WCDMA adjacent-channel power ratio (5 MHz offset, 3.84 Mcps): -67 dBc (1 DPCH)
- ◆ Typical IS-95 CDMA adjacent-channel power ratio (885 kHz offset): -78 dBc (9 code channels)

#### Enhanced Functions for WCDMA 3GPP (FDD) Digital Standard R&S®SMIQB48

This option expands the functionality of option R&S®SMIQB45 WCDMA 3GPP. It allows the generation of up to four enhanced channels that can be combined with the standard channels.

- ◆ Very long signal sequences and continuous PRBS sequences (e.g. PN9) often required for BER measurements can be implemented for the channel under test

<sup>1)</sup> Without switching the mechanical attenuators.



Contents Overview

Chapter Overview

Type Index

R&amp;S Addresses





Contents Overview

Chapter Overview

Type Index

R&amp;S Addresses



## Vector Signal Generator R&S®SMIQ

- ◆ Use of externally precoded data or the generation of long power control profiles for the DUT
- ◆ Testing the closed-loop power control function of a mobile station
- ◆ Receiver and performance tests to TS 25.101, TS 25.104, TS25.141 and TS25.944
- ◆ Realistic simulation of WCDMA scenarios
- ◆ Creation and insertion of bit errors into the data of enhanced channels
- ◆ Insertion of block errors (BLERs) into the channel-coded data
- ◆ Generation of WCDMA signals of up to 2 minutes repetition rate

### Enhanced Fading Functions for W-CDMA 3GPP R&S®SMIQB49

Option R&S®SMIQB49 extends the functionality of fading options R&S®SMIQB14 /B15 to include WCDMA 3GPP channel simulation. It adds three new modes to the fading simulator so that all scenarios defined in 3GPP Release 99 can be simulated:

- ◆ In fine delay mode, fading simulator resolution is increased to 1 ns with up to four paths being available
- ◆ In moving delay mode, two paths are simulated: for one path the delay remains constant, whereas for the other path the delay varies continuously
- ◆ In birth-death mode, there are two paths changing delay in steps in accordance with the 3GPP channel model

### Digital Standard GPS R&S®SMIQB51

This option allows the static signal of a GPS satellite to be simulated. This enables the user to carry out basic GPS receiver testing. The most important

settings according to GPS standard can be activated on the R&S®SMIQ by a keystroke.

The data sources available are bit patterns of up to 16 bits in length and data lists. It is also possible to use navigation data. Several navigation data lists (i.e. 25 frames of GPS navigation data) can be generated by means of the free external "Almanac Uploader" PC software.

### TETRA T1 Simulator R&S®SMIQ-K8

R&S®SMIQ-K8 is a PC-based software package for generating TETRA T1, T2, T3, T1&T2 or T1&T3 test signals to ETS300-392/ETS300-394. It is designed for putting RF components into operation and supporting ETS300394-1 tests. R&S®SMIQ-K8 generates all the data sequences including all the control sequences required to operate the signal generator.

Characteristics:

- ◆ The TETRA frame (bit stream) is generated according to the selected burst type, i.e. control burst (CB), normal burst (NB) or synchronizing burst (SB)
- ◆ The frames are generated for the uplink (mobile station [MS] transmitting) and the downlink (base station [BS] transmitting)
- ◆ The channel types ACH, BSCH, BNCH, TCH, STCH and SCH are generated
- ◆ Channel coding is performed for all channels; scrambling with system code, base colour code, mobile country code and mobile network code can be set separately for each channel
- ◆ Frame repetition of 1 to 180 multi-frames can be selected via sequence length

- ◆ The T1 test signal is generated for the V + D (voice and data) test on MS and BS DUTs
- ◆ Channel types 1 to 4, 15 and 17 can be set for the downlink and channel types 7 to 11, 16 and 18 for the uplink
- ◆ The bit stream can be generated either from pseudo-random sequences (CCITT 0.153) or from user-selectable sequences
- ◆ The R&S®SMIQ-K8 software package calculates the appropriate TETRA T1 signal and transfers it to the R&S®SMIQ via the GPIB or RS-232-C interface; all the R&S®SMIQ settings that are needed are included. Additionally the R&S®SMIQ-K8 can operate a second R&S®SMIQ simultaneously for generating a TETRA T2 or T3 signal (TETRA T1, T2, T3, T1&T2 or T1&T3).

### Arbitrary Waveform Generator R&S®SMIQB60

To further enhance the versatility of the modulation coder, a dual-channel arbitrary waveform generator (ARB) with a maximum clock rate of 40 MHz is available as an option. It can store up to 512 ksamples of externally computed I/Q values.

The supplied R&S®WinIQSIM™ software (see page 263) allows the calculation of arbitrary modulation signals, for example COFDM, multicarrier and noise, and downloading them into R&S®SMIQ. Together with a convenient data editor, R&S®WinIQSIM™ can calculate any kind of TDMA frame configuration, simulate impairments by superimposed interference signals, etc.



Contents Overview

Chapter Overview

Type Index

R&amp;S Addresses





Contents Overview

Chapter Overview

Type Index

R&S Addresses



## Vector Signal Generator R&S®SMIQ

### Specifications in brief

You will find detailed and binding data on the enclosed CD (./DATASHEET/SMIQ.pdf), or, for the latest updates, visit [www.rohde-schwarz.com](http://www.rohde-schwarz.com), search term: **SMIQ**

#### Frequency

Range	R&S®SMIQ02B/03B/04B/06B	300 kHz to 2.2/3.3/4.4 GHz/6.4 GHz
<b>Level</b>		
Range	R&S®SMIQ02B/03B R&S®SMIQ04B/06B	-144 dBm to +13 dBm (PEP) -144 dBm to +10 dBm (PEP)
Overranging without warranty of specs		up to 16 dBm
Total level uncertainty	>-127 dBm	typ. <±0.5 dB (f ≤ 2 GHz)
Frequency response at 0 dBm		typ. <0.3 dB (f ≤ 3.3 GHz)
<b>Spectral purity</b>		
Spurious, harmonics at levels ≤ 10 dBm		<-30 dBc (R&S®SMIQ02B/03B)
Spurious, harmonics at levels ≤ 7 dBm		<-30 dBc (R&S®SMIQ04B/06B)
Broadband noise, carrier offset > 5 MHz, f > 450 MHz to 3040 MHz, CW		typ. -144 dBc
Broadband noise, vector modulation, (f > 20 MHz) carrier offset > 5 MHz		typ. -137 dBc
SSB phase noise, carrier offset 20 MHz, 1 Hz bandwidth f = 1 GHz	CW	Vector modulation (dig. modulation) <-126 dBc
<b>Sweep</b>		
RF sweep, AF sweep		digital sweep in discrete steps
Modes		automatic, single shot, manual or external trigger, linear or logarithmic

#### Modulation

<b>Internal modulation generator</b>		
Frequency range		0.1 Hz to 1 MHz
Vector modulation		2 inputs (I and Q)
Amplitude modulation <sup>2)</sup>		internal, external AC/DC
Broadband amplitude modulation		external DC
Pulse modulation		external
<b>Frequency modulation</b>	<b>Option R&amp;S®SM-B5</b>	int., external AC/DC, two-tone with two modulation channels FM1 and FM2
Max. deviation		0.5/1/2/4 MHz depending on frequency
<b>Phase modulation</b>	<b>Option R&amp;S®SM-B5</b>	int., external AC/DC, two-tone with two modulation channels φM1 and φM2
Max. deviation		5/10/20/40 rad depend. on frequency
<b>Digital modulation</b>	<b>Option R&amp;S®SMIQB20</b>	internal, external, serial, ext. parallel
<b>Predefined modulation settings</b>		
APCO C4FM, APCO QPSK, CDPD, CT2, DECT, GSM, IRIDIUM, NADC, PDC, PHS, TETRA, TETS, PWT, ICO BPSK, ICO GMSK, ICO QPSK, GSM/EDGE, CDMA IS-95, WCDMA, QPSK		
Envelope control		internal or external
Range of function		1 ksymbol/s to 2.5 Msymbol/s
Modulation modes		ASK, FSK, GMSK, PSK, QAM
ASK, symbol rate		100 symbol/s to 18 Msymbol/s
FSK, modulation modes		2FSK, 4FSK, 4FSK APCO, GFSK
GMSK, bit rate		100 bit/s to 7.5 Mbit/s <sup>1)</sup>
PSK, modulation modes		BPSK, QPSK, OQPSK, QPSK (IS-95), OQPSK (IS-95), QPSK (ICO), QPSK (INMARSAT), π/4DQPSK, π/4QPSK, 8PSK, 8PSK EDGE
QAM, modulation modes		16QAM, 32QAM, 64QAM, 256QAM

<b>Data generator</b>	<b>Option R&amp;S®SMIQB11</b>
Programmable data memory for modulation data, envelope-control and trigger signals. The data generator can be operated only in conjunction with the optional modulation coder	
Max. symbol rate	8.5 Msymbol/s
Operating modes	automatically repeating, single shot, manually or externally triggered
<b>Memory extension</b>	<b>Option R&amp;S®SMIQB12</b>
The data generator memory can be extended to max. 79 Mbit by fitting up to two options R&S®SMIQB12.	
Memory capacity	32 Mbit
<b>Digital standards</b>	<b>Options R&amp;S®SMIQB20/SMIQB11</b>
GSM/EDGE	according to GSM standard
DECT	according to ETS300175-2 and ETS300176-1
NADC	according to IS-54 and IS-136
PDC	according to RCR STD-27
PHS	according to RCR STD-28
<b>Digital standard IS-95 CDMA</b>	<b>Option R&amp;S®SMIQB42</b>
According to TIA standard IS-95A and J-STD-008	
<b>Digital standard WCDMA</b>	<b>Option R&amp;S®SMIQB43</b>
Modulation	QPSK, OQPSK
<b>Digital standard WCDMA 3GPP (FDD)</b>	<b>Option R&amp;S®SMIQB45<sup>3)</sup></b>
according to 3GPP standard 3.4.0 (FDD)	
3GPP (FDD) version	optional 3.4.0, according to technical specifications 3GPP TS25.211 and TS25.213
<b>Simultaneous modulation</b>	
Any combination is possible with the following exceptions:	
- Simultaneous FM and φM	
- Simultaneous digital modulation and vector modulation	
Pulse modulation cannot be used together with level attenuation function LEV ATT (option R&S®SMIQB20)	

#### Options for special applications

<b>Fading simulation</b>	<b>Options R&amp;S®SMIQB14/SMIQB15</b>
paths and channels with option R&S®SMIQB14 with options R&S®SMIQB14/-B15	6 paths, 1 channel 12 paths, 1 channel or 6 + 6 paths, 2 channels with second R&S®SMIQ through simple retrofit
Path attenuation	
Simulation types	Rayleigh fading, Rice fading, Lognormal fading, Suzuki fading
Correlation	paths 1 to 6 with paths 7 to 12
<b>Enhanced fading functions for WCDMA 3GPP</b>	<b>Option R&amp;S®SMIQB49</b>
The following data deviate from the specifications for R&S®SMIQB14/ R&S®SMIQB15	
Fine delay mode	
Number of paths	2 (with R&S®SMIQB14), 4 (with R&S®SMIQB14 + R&S®SMIQB15)
Profiles	Rayleigh, pure Doppler
Moving delay mode	
Number of paths	2
Birth-death mode	
Number of paths	2
Profiles	pure Doppler
<b>Noise and distortion simulation</b>	<b>Option R&amp;S®SMIQB17</b>
Distortion simulator	AM/AM and AM/φM distortion of modulation signal
Distortion characteristic	each characteristic programmable by entering up to 30 input values via IEC/IEEE bus or by entering up to five polynomial coefficients
Noise generator (AWGN)	
Distribution density	Gaussian, statistically indep. for I and Q



Contents Overview

Chapter Overview

Type Index

R&S Addresses



## Vector Signal Generator R&amp;S®SMIQ

<b>Bit error rate measurement</b>	<b>Option R&amp;S®SMIQB21</b>
Measurement time	selectable through maximum number of data bits or bit errors (max. 2 <sup>31</sup> bits each), continuous measurement
Measurement result	BER in ppm, % or decade values (if selected number of data bits or bit errors is attained) status displays: not synchronized, no clock, no data
<b>Improved adjacent-channel power ratio for WCDMA and CDMA IS-95</b>	<b>Option R&amp;S®SMIQB47</b>
Selectable baseband filters to improve ACP values (values see at Digital Standards CDMA/WCDMA)	
<b>Enhanced functions for digital standard WCDMA 3GPP (FDD)</b>	<b>Option R&amp;S®SMIQB48</b>
3GPP (FDD) version	3.4.0 to 3GPP technical specifications TS25.101, TS25.104, TS25.141, TS25.211 and TS25.213
<b>Enhanced Channels</b>	
Channels of W-CDMA system in R&S®SMIQ that offer enhanced functionality compared with standard channels of option R&S®SMIQB45. Can be used in downlink for max. four DPCHs and in uplink for one DPCH and max. three DPDCHs. All DPCHs or DPDCHs have the same symbol rate.	
Enhanced functions at a glance:	
Sequences of up to 1042 frames; data lists for data fields and TPC field; external power control; channel coding; bit error insertion; block error insertion; simulation of realistic noise scenarios; orthogonal channel noise simulation (OCNS); additional mobile stations	
<b>Digital Standard GPS</b>	<b>Option R&amp;S®SMIQB51</b>
Channels	1, simulation of one GPS satellite
Function:	
Simulation of static signal of GPS satellite using option SMIQB51; prerequisites: SMIQB11 (data generator) and SMIQB20 (modulation coder), SMIQ firmware version 5.65 or higher	
Navigation data:	
user-selectable bit patterns of up to 16 bit, user-definable data lists of any length, length only limited by memory capacity (SMIQB11, SMIQB12), simple generation of several navigation data lists of 37500 bits each, i.e. 25 frames of GPS navigation data, for example by means of free external PC software "AlmanacUploader", Application Note 1GP46	
<b>Arbitrary waveform generator</b>	<b>Option R&amp;S®SMIQB60</b>
Length of waveform	1 to 524216 in steps of one sample
Resolution	12 bit
Downloading time for 512k I/Q samples	4 s
Nonvolatile memory	
Number of blocks	22
Block size	24 from firmware version 5.30
Interpolation	65527
Signal output, channels	2 (I and Q)
Trigger modes	auto, retrigger, armed auto, armed retrigger
Trigger source	internal or external
Trigger outputs	2
Delay	0 to 524216 samples
On time, off time	1 to 524215 samples
<b>General data</b>	
Memory for instrument settings	50 storable settings
List Mode: Frequency and level values can be stored in a list and set in an extremely short time; permissible level variation: 90 dB	
Max. number of channels	2000
Remote control	IEC 625 (IEEE 488)
Power supply	90 V to 265 V (AC), 50 Hz to 400 Hz, autoselecting to AC supply, max. 300 VA
Dimensions (W × H × D)	435 mm × 192 mm × 460 mm
Weight	25 kg when fully equipped

## Ordering information

<b>Vector Signal Generator</b>		
300 kHz to 2.2 GHz	R&S®SMIQ02B	1125.5555.02
300 kHz to 3.3 GHz	R&S®SMIQ03B	1125.5555.03
300 kHz to 4.4 GHz	R&S®SMIQ04B	1125.5555.04
300 kHz to 6.4 GHz	R&S®SMIQ06B	1125.5555.06
<b>Accessories supplied</b>	power cable, operating manual	
<b>Options</b>		
Reference Oscillator OCXO	R&S®SM-B1	1036.7599.02
FM/φM Modulator	R&S®SM-B5	1036.8489.02
Data Generator	R&S®SMIQB11	1085.4502.04
Memory Extension, 32 Mbit	R&S®SMIQB12	1085.2800.04
Fading Simulator, 6 paths	R&S®SMIQB14	1085.4002.02
Second Fading Simulator for 12 paths or 2 channels	R&S®SMIQB15	1085.4402.02
Noise Generator & Distortion Simulator	R&S®SMIQB17	1104.9000.02
RF and AF Rear Connectors	R&S®SMIQB19	1085.2997.02
Modulation Coder	R&S®SMIQB20	1125.5190.02
BER Measurement	R&S®SMIQB21	1125.5490.02
Digital Standard IS-95 CDMA	R&S®SMIQB42	1104.7936.02
Digital Standard WCDMA acc. to NTT DoCoMo 1.0, ARIB 0.0 standard	R&S®SMIQB43 <sup>2)</sup>	1104.8032.02
Digital Std. WCDMA acc. to 3GPP (FDD)	R&S®SMIQB45 <sup>1)</sup>	1104.8232.02
Low ACP for IS-95 CDMA and W-CDMA	R&S®SMIQB47	1125.5090.02
Extended Functions for WCDMA (3GPP)	R&S®SMIQB48	1105.0587.02
Ext. Fading Funct. for WCDMA (3GPP)	R&S®SMIQB49	1105.1083.02
Digital Standard GPS	R&S®SMIQB51	1105.1683.02
Arbitrary Waveform Generator incl. R&S®WinIQSIM™	R&S®SMIQB60	1136.4390.02
TETRA T1 Simulator	R&S®SMIQ-K8	1136.4290.02
Software for R&S®SMIQB60		
Digital Standard IS-95 CDMA	R&S®SMIQK11	1105.0287.02
Digital Standard cdma2000	R&S®SMIQK12	1105.0435.02
Dig. Std. WCDMA TDD mode (3GPP)	R&S®SMIQK13	1105.1231.02
Digital Standard TD-SCDMA	R&S®SMIQK14	1105.1338.02
OFDM Signal Generation, HIPER LAN/2	R&S®SMIQK15	1105.1531.02
Digital Standard 1xEV-DO	R&S®SMIQK17	1154.7800.02
Digital Standard IEEE 802.11	R&S®SMIQK19	1154.8307.02
Digital Std. 3GPP FDDA incl. HSDPA	R&S®SMIQK20	on request

Additional hint: R&S®SMIQ02B/03B (R&S®SMIQ04B/06B) can be equipped with up to three (two) of the following options: R&S®SM-B5, R&S®SMIQB14, R&S®SMIQB15, R&S®SMIQB17

**Application software**

Generation of Data and Control Lists	R&S®SMIQ-K1	1)
Bluetooth signals for R&S®SMIQ	R&S®SMIQ-K5	1)
User mappings and user filters for R&S®SMIQ	User Mod	1)
IQWizard <sup>1)</sup>		1)

<sup>1)</sup> available on www.rohde-schwarz.com

**Extras**

19" Adapter	R&S®ZZA-94	0396.4905.00
Service Kit	R&S®SM-Z3	1085.2500.02
BNC Adapter for rear panel, D type connector PAR DATA	R&S®SMIQ-Z5	1104.8555.02
90° Power Splitter	R&S®SMIQ-Z9	1104.9580.02
Trolley for Transit Case	R&S®ZZK-1	1014.0510.00
Transit Case	R&S®ZZK-944	1013.9366.00
Service Manual R&S®SMIQ		1085.2445.24

## Vector Signal Generator R&S® SMIQ03HD

2110 MHz to 2170 MHz

Dedicated to 3GPP,

special model of Vector Signal

Generator R&S® SMIQ

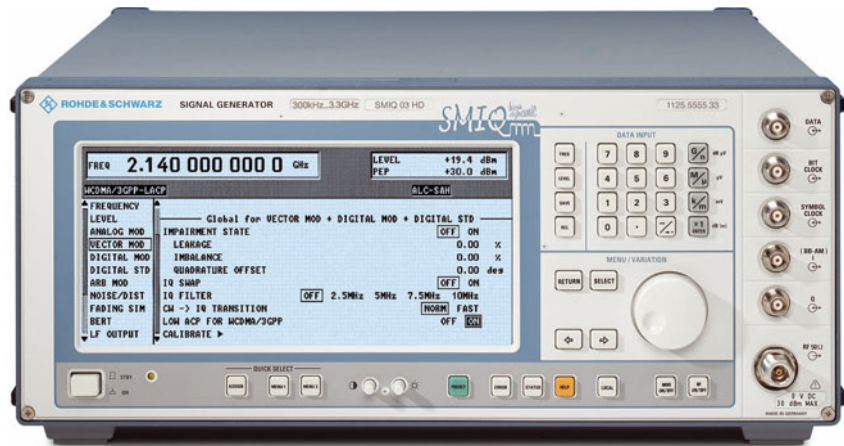

### Brief description

The signal statistics of a WCDMA signal reveal high crest factors (peak-to-average power ratios). Therefore, amplifiers with a wide linear range are required to ensure distortion-free transmission not only of average transmit power but also of high power peaks.

The requirements on base station power amplifiers become even more stringent since the amplifiers also transmit multicarrier signals within the 60 MHz downlink band. In addition to single-carrier power amplifiers (SCPAs), multicarrier power amplifiers (MCPAs) are increasingly used. Signal sources featuring wide

dynamic range and high accuracy, such as the R&S® SMIQ03HD, are required for the development and production testing of the amplifiers. WCDMA specifications allow base stations only a very low adjacent-channel power (ACP).

SCPA	Description	Type	Order No.
Internal baseband generation	<b>Vector Signal Generator</b>	R&S® SMIQ03HD	1125.5555.33
	Modulation Coder	R&S® SMIQB20	1125.5190.02
	Data Generator	R&S® SMIQB11	1805.4502.04
	Digital Standard WCDMA 3GPP (FDD)	R&S® SMIQB45	1104.8232.02
Ext. baseband generation (e.g. using R&S® AMIQ)	High ACLR for WCDMA 3GPP	R&S® SMIQB57	1105.1831.02
	<b>Vector Signal Generator</b>	R&S® SMIQ03HD	1125.5555.33
	High ACLR for WCDMA 3GPP	R&S® SMIQB57	1105.1831.02
	I/Q Modulation Generator, incl. R&S® WinIQSIM™	R&S® AMIQ	1110.2003.04

MCPA	Description	Type	Type	Order No.	
Internal baseband generation	<b>Vector Signal Generator</b>	R&S® SMIQ03HD	Multicarrier signals with two or more R&S® SMIQ03HD externally combined	R&S® SMIQ03HD	1125.5555.33
	Modulation Coder	R&S® SMIQB20		R&S® SMIQB20	1125.5190.02
	Data Generator	R&S® SMIQB11		R&S® SMIQB11	1805.4502.04
	Digital Standard WCDMA 3GPP FDD	–		R&S® SMIQB45 <sup>1)</sup>	1104.8232.02
	High ACLR for WCDMA 3GPP	–		R&S® SMIQB57	1105.1831.02
	Arbitrary Waveform Generator incl. R&S® WinIQSIM™	R&S® SMIQB60		–	1136.4390.02
Ext. baseband generation (e.g. using R&S® AMIQ)	<b>Vector Signal Generator</b>	R&S® SMIQ03HD	R&S® SMIQ03HD	1125.5555.33	
	I/Q Modulation Generator, incl. R&S® WinIQSIM™	R&S® AMIQ	R&S® AMIQ	1110.2003.04	

<sup>1)</sup> Alternatively WCDMA 3GPP FDD signals can be generated with the option R&S® SMIQB60 (1136.4390.02) and R&S® WinIQSIM™



Contents Overview

Chapter Overview

Type Index

R&S Addresses



## Vector Signal Generator R&S®SMIQ03HD

The R&S®SMIQ03HD supplies a test signal whose adjacent-channel leakage ratio (ACLR) is much better than the one required for base stations so that measurements can be carried out on amplifiers with sufficient dynamic range.

### Main features

- ◆ Wide dynamic range: ACLR typ. 70 dB for 3GPP test model 1/64
- ◆ Single-carrier scenarios: further improvement of ACLR (typ.77 dB) with option R&S®SMIQB57. Band-specific solution (3GPP downlink) combined with high output power (up to +30 dBm PEP)
- ◆ Multicarrier scenarios: integrated baseband filters to improve ACLR for 1 to 4 W-CDMA carriers
- ◆ Optional fading simulator (R&S®SMIQB14/B15) and noise generator/distortion simulator (R&S®SMIQB17)
- ◆ Short frequency and level setting time

### Specifications in brief

**You will find detailed and binding data on the enclosed CD (./DATASHEET/SMIQ03HD.pdf), or, for the latest updates, visit [www.rohde-schwarz.com](http://www.rohde-schwarz.com), search term: SMIQ03HD**

For general data please refer to the R&S®SMIQ standard data sheet (PD 0757.2438). The following data differs from the standard data or pertains to additional features.

#### Digital Standard WCDMA 3GPP (FDD) (option R&S®SMIQB45)

Single-carrier measurements (low-noise output mode)	
ACLR (1850 MHz to 2200 MHz, level ≤8 dBm (PEP))	
1 DPCH (crest factor 5.4 dB, I/Q filter 2.5 MHz, offset 10 MHz)	typ. 76 dB
Test model 1, 64 DPCH (crest factor 10.6 dB, I/Q filter 2.5 MHz, offset 10 MHz)	typ. 73 dB
ACLR	
1 DPCH (crest factor 5.4 dB, average power ≤10 dBm, offset 10 MHz)	typ. 84 dB
Test model 1, 64 DPCH (crest factor 10.6 dB, average power ≤10 dBm, offset 10 MHz)	typ. 82 dB
Multicarrier measurements (low-noise output mode)	
ACLR (2110 MHz to 2170 MHz, level ≤8 dBm (PEP); multicarrier signals generated with the internal Arbitrary Waveform Generator R&S®SMIQB60)	
2 carriers, test model 1, 64 DPCH (crest factor 11 dB, I/Q filter 5 MHz, offset 10 MHz)	typ. 68 dB
3 carriers, test model 1, 64 DPCH (crest factor 11.3 dB, I/Q filter 7.5 MHz, offset 10 MHz)	typ. 65 dB
4 carriers, test model 1, 64 DPCH (crest factor 11.8 dB, I/Q filter 10 MHz, offset 10 MHz)	typ. 64 dB

#### High ACLR for WCDMA 2110 MHz to 2170 MHz (option R&S®SMIQB57)

Frequency range	2110 MHz to 2170 MHz
3GPP channel bandwidth	3.84 MHz
Level	
Output level (PEP), normal output mode	-130 dBm to 27 dBm
Overrange	30 dBm
Uninterrupted level setting (attenuator mode fixed)	>30 dB
Repeatability (ALC STATE ON (CW mode))	typ. 0.05 dB
Linearity error (in displayed level range, attenuator mode fixed)	typ. 0.1 dB

Total level uncertainty	
Attenuator mode auto (-120 dBm to 25 dBm (PEP))	
CW	<0.5 dB
Digital modulation	<0.7 dB
Spectral purity	
Harmonics	
Level <25 dBm (PEP)	<-30 dBc, typ. -40 dBc
Level <15 dBm (PEP)	<-40 dBc, typ. -50 dBc
Nonharmonics, carrier offset >10 kHz	<-86 dBc
Subharmonics	none
Error vector magnitude (W-CDMA, 3.84 Mcps), rms	typ. 4%

#### Restrictions on other data when using option R&S®SMIQB57

**General:** Modulation bandwidth is reduced to 3GPP channel bandwidth. Due to steep bandpass filtering, additional amplitude and group delay distortions occur.

Topic concerned	Remark
- Broadband amplitude modulation	-
- Digital modulation	Increased EVM at higher symbol rates
- Digital Standard IS-95 CDMA R&S®SMIQB42	850 kHz I/Q filter not provided
- Digital Standard WCDMA R&S®SMIQB43, Digital Standard WCDMA 3GPP (FDD) R&S®SMIQB45, Enhanced Functions for Digital Standard WCDMA 3GPP (FDD) R&S®SMIQB48	Increased EVM
- Arbitrary Waveform Generator R&S®SMIQB60	-
- Fading Simulators R&S®SMIQB14/15	-
- Noise Generator/Distortion Simulator R&S®SMIQB17	-
- Amplitude modulation	Not possible with R&S®SMIQB57
- Level setting, attenuator mode electronic	Not possible with R&S®SMIQB57
- Level setting, ALC OFF, MODE TABLE	Not possible with R&S®SMIQB57

### Ordering information

<b>Vector Signal Generator</b>	R&S®SMIQ03HD	1125.5555.33
<b>Accessories supplied</b>	power cable, operating manual	
<b>Option</b>		
High ACLR for WCDMA 3GPP	R&S®SMIQB57 <sup>1)</sup>	1105.1831.02

<sup>1)</sup> Factory installation only.



Contents Overview

Chapter Overview

Type Index

R&S Addresses





Contents Overview

Chapter Overview

Type Index

R&amp;S Addresses



## Vector Signal Generator R&S®SMV03

9 kHz to 3.3 GHz

Vector modulation in the  
analog class



### Brief description

The Vector Signal Generator R&S®SMV03 is based on the successful analog Signal Generator R&S®SML03 and so features the same excellent technical characteristics. It comprises an additional broadband I/Q modulator which is able to generate any digital signal in conjunction with an external I/Q source. The R&S®SMV03 is, therefore, a way of entering the wide field of automatic test systems as well as gaining access to applications like R&D and service. When used together with R&S®AMIQ and R&S®WinIQSIM™, the R&S®SMV03 can generate digital signals that meet any requirement.

### Main features

#### RF characteristics

- ◆ Frequency range from 9 kHz to 3.3 GHz with 0.1 Hz resolution
- ◆ High output level of +13 dBm with a deviation <0.5 dB
- ◆ Interruption-free level setting by electronic attenuator
- ◆ High spectral purity (<-122 dBc (1 Hz) at f = 1 GHz with 20 kHz carrier offset)
- ◆ Frequency and level setting time <10 ms

#### Vector modulation

- ◆ Wide I/Q bandwidth of >50 MHz (3 dB), 100 MHz RF bandwidth for f >500 MHz to 3 GHz
- ◆ High vector accuracy

#### Analog modulation

- ◆ AM/FM/ϕM as standard
- ◆ Simultaneous AM, FM/ϕM, pulse and vector modulation
- ◆ Optional pulse modulator with integrated pulse generator (R&S®SML-B3)

#### Size

- ◆ Compact size
- ◆ Low weight <9.5 kg

#### User friendly

- ◆ One-hand operation with EasyWheel
- ◆ Settings simple and self-explanatory
- ◆ High-contrast LCD
- ◆ User-assignable menu keys
- ◆ Online help including IEC/IEEE-bus commands

#### Low Cost of Ownership

- ◆ 3-year calibration cycle
- ◆ Electronic attenuator for wear-free operation
- ◆ Service-friendly (continuous selftest, access to internal test points)

#### Production: fast, accurate, reliable

#### Versatility

The R&S®SMV03 generates all kinds of I/Q-modulated signals using the integrated vector modulator. Thanks to its wide bandwidth of 50 MHz, the R&S®SMV03 is also optimally suited for applications using high data rates such as WLAN standards. Signals to digital

standards can be easily generated in conjunction with an external I/Q source like the Modulation Generator R&S®AMIQ and the associated R&S WinIQSIM™ simulation software.

#### Dimensions

The compact size (only 2 HU) makes the R&S®SMV03 ideal for use in production where space is often limited.

#### Speed

Speed is essential – especially in production. And this is exactly where the R&S®SMV03 shows what it can do with a frequency and level setting time of <10 ms.

#### Accuracy

Any measurement uncertainty has two components: the uncertainty due to the measuring instrument and that due to the rest of the test setup. The lower the level uncertainty of the vector signal generator, the greater the test setup tolerance that may be allowed. If greater tolerances can be allowed for the DUT because of the small level error of the R&S®SMV03, production rejects can be markedly reduced – an advantage that pays off immediately.

#### Reliability

A signal generator used in production must feature high reliability. The R&S®SMV03 meets this requirement for example through the use of a completely wear-free electronic attenuator.



Contents Overview

Chapter Overview

Type Index

R&amp;S Addresses





## Vector Signal Generator R&S®SMV03

### Output level

In production test systems, the signal is routed to the DUT via switches and cables which introduce losses. This can be compensated for by the high output power of the R&S®SMV03.

### Lab and R&D: versatile

#### Versatile modulation modes

Particularly in research, a great variety of digital signals are used in the development of new systems, which are not always covered by a standard. Thanks to its very wideband I/Q modulator, the R&S®SMV03 can handle universal tasks of this kind.

Also, the vector signal generator, in conjunction with the optional Pulse Modulator R&S®SML-B3, can handle all types of analog modulation. AM, FM/φM and pulse modulation can be used simultaneously as can vector modulation, FM/φM and pulse modulation.

#### High spectral purity

Thanks to its low phase noise R&S®SMV03 is ideally suited to replace LOs.

#### High and accurate output level

The high level accuracy of the Vector Signal Generator R&S®SMV03 is a prerequisite for highly accurate measurements on sensitive analog and digital receivers. Its high output level makes the R&S®SMV03 an ideal source for driving high-level mixers.

*Typical SSB phase noise at 1 GHz  
(with OCXO option R&S®SML-B1)*

### Servicing: robust, compact, lightweight

#### Mobility

R&S®SMV03 is lightweight (<9.5 kg) and compact and therefore very easy to transport.

#### Flexible control

In service environments, an IEC/IEEE interface is not always available to control the generator. This is not a problem as the R&S®SMV03 can also be controlled via a standard RS-232-C interface.

#### Protection against overvoltage

The integrated overvoltage protection of the RF output protects the R&S®SML against very high external voltages such as may occur during transceiver measurements.

### EMS measurements

#### Interruption-free level setting without overshoots

EMS measurements require interruption-free level setting which should also be overshoot-free. The R&S®SMV03 does not produce any overshoots – even at setting times <10 ms. Furthermore, it has a wide dynamic range of typ. 30 dB over which level adjustment is interruption-free.

#### Wide frequency range

R&S®SMV03 features a lower frequency limit of 9 kHz as standard and so fully covers the frequency range required for EMC measurements.

#### Reference source

R&S®SMV03 allows selection of the mode of frequency generation. In the Extended Divider Range mode, the RF signal is generated by frequency division. The excellent values obtained in this mode for SSB phase noise are comparable to those from the high-grade crystal oscillators normally used as reference sources from 10 MHz to 30 MHz.

### Stereo/RDS Coder R&S®SML-B5 (option)

Fitted with the new option, the signal generators of the tried and tested R&S®SML and R&S®SMV families generate stereo-modulated RF signals to standard for use in production, development and service. At the core of this option is a digital signal processor (DSP) that generates stereo, RDS and ARI signals of outstanding quality, which is fully sustained owing to the excellent FM modulators in the generators.

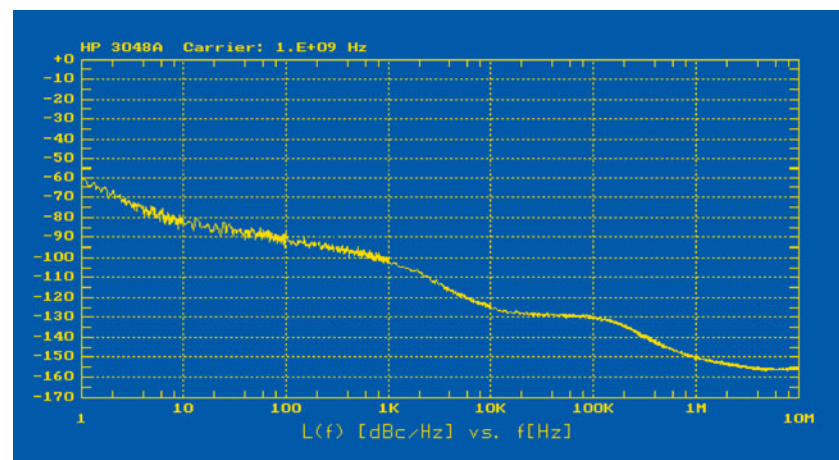

## Vector Signal Generator R&S®SMV03

### Specifications in brief

You will find detailed and binding data on the enclosed CD (./DATASHEET/SMV03.pdf), or, for the latest updates, visit [www.rohde-schwarz.com](http://www.rohde-schwarz.com), search term: SMV03

<b>Frequency</b>	
I/Q modulation off	9 kHz to 3.3 GHz
I/Q modulation on	5 MHz to 3.3 GHz
Resolution	0.1 Hz
<b>Spectral purity</b>	
Harmonics spurious signals <sup>1)</sup>	
f ≤ 20 kHz	< -25 dBc at levels ≤ +8 dBm
f > 20 kHz	< -30 dBc at levels ≤ +8 dBm
Subharmonics spurious signals	
f ≤ 1.1 GHz	-
f > 1.1 GHz	< -50 dBc
Nonharmonics spurious signals (carrier offset > 10 kHz)	
f ≤ 1.1 GHz	< -70 dBc
f > 1.1 GHz to 2.2 GHz	< -64 dBc
f > 2.2 GHz to 3.3 GHz	< -58 dBc
Broadband noise <sup>2)</sup> (f = 1 GHz, carrier offset > 2 MHz, 1 Hz bandwidth)	< -140 dBc, typ. -150 dBc
SSB phase noise (f = 1 GHz, 20 kHz carrier offset, 1 Hz bandwidth)	< -122 dBc, typ. -128 dBc
Spurious FM, rms (f = 1 GHz)	
0.3 kHz to 3 kHz	typ. < 4 Hz, 1 Hz
0.03 kHz to 20 kHz	typ. < 10 Hz, 3 Hz
Spurious AM, rms	
0.03 kHz to 20 kHz	< 0.02%
<b>Level</b>	
Range	-140 dBm to +13 dBm <sup>2)</sup> (overrange +19 dBm)
Resolution	0.1 dB
Level accuracy <sup>2)</sup> <sup>3)</sup> (level > -120 dBm)	
100 kHz to ≤ 2 GHz	< 0.5 dB
Frequency response at 0 dBm <sup>2)</sup> <sup>3)</sup>	
100 kHz to ≤ 2 GHz	< 0.7 dB
Setting time (IEC/IEEE bus), f > 100 kHz	< 10 ms, typ. 5 ms
Interruption-free level setting <sup>4)</sup>	
I/Q modulation off	20 dB, overrange 30 dB
I/Q modulation on	15 dB, overrange 20 dB
<b>Overvoltage protection</b>	
safeguards unit against externally applied RF power and DC voltage (50 Ω source)	
Max. permissible RF power (f ≤ 2.2 GHz)	50 W
Max. permissible DC voltage	35 V
<b>Sweep</b>	
digital in discrete steps	
RF sweep, AF sweep	
automatic, single-shot, manually or externally triggered, linear or logarithmic	
Sweep range	user-selectable
Step width (lin)	user-selectable
Step width (log)	0.01% to 100%
Level sweep	
automatic, single-shot, manually or externally triggered, logarithmic	
Sweep range	user-selectable
Step width (log)	user-selectable
Step time/resolution	10 ms to 1 s/0.1 ms

<b>Vector Modulation</b>	external DC
I and Q modulation inputs	< 1.2
Input voltage for full-scale level	$\sqrt{I^2 + Q^2} = 0.5 \text{ V}$ (1 V into 50 Ω)
Static error vector <sup>5)</sup> , level < +8 dBm	
Rms value	< 0.5%
Peak value	< 1%
Modulation frequency response	
f > 500 MHz to 3 GHz, DC to 5 MHz	< 0.4 dB
Residual carrier at 0 V input voltage referred to max. input voltage	
	< -45 dBc
I/Q imbalance	
Carrier leakage (setting range)	0% to 50%
I≠Q (setting range)	-12% to +12%
Quadrature offset (setting range)	-10° to +10°
Adjacent-channel power	
WCDMA 3GPP FDD (f = 2.14 GHz)	
Test model 1 (64 DPCHs), offset 10 MHz	typ. -66 dBc
<b>Internal modulation generator</b>	
Frequency range; resolution	0.1 Hz to 1 MHz; 0.1 Hz
Frequency response (up to 500 kHz, level > 100 mV)	
	< 0.5 dB
THD (< 100 kHz, level 4 V, 600 Ω)	< 0.1%
Open-circuit voltage V <sub>o</sub> (LF connector)	1 mV to 4 V
Frequency setting time (after reception of last IEC/IEEE-bus character)	< 10 ms
<b>Simultaneous modulation</b>	
	AM, FM/ϕM and pulse modulation or vector modulation, FM/ϕM and pulse modulation
<b>Amplitude modulation <sup>6)</sup></b>	
	internal, external AC/DC, internal/external two-tone
Modulation depth	0% to 100%
settable modulation depth continuously decreasing between +7 dBm and +13 dBm <sup>7)</sup> while adhering to AM specifications; a status message is output when the modulation depth is too high	
Modulation frequency range (< 3 dB)	DC/10 Hz to 50 kHz
Setting accuracy at 1 kHz (m < 80%) <sup>8)</sup>	< 4% of reading + 1%
AM distortion at 1 kHz	
m = 30%	< 1%
m = 80%	< 2%
Incidental ϕM at AM (30%), AF = 1 kHz	< 0.2 rad
<b>Frequency modulation</b>	
	internal, external AC/DC, internal/external two-tone
Frequency deviation	
9 kHz to 76 MHz	0 Hz to 1 MHz
> 76 MHz to 151.3125 MHz	0 Hz to 125 kHz
> 151.3125 MHz to 302.625 MHz	0 Hz to 250 kHz
> 302.625 MHz to 605.25 MHz	0 Hz to 500 kHz
> 605.25 MHz to 1.2105 GHz	0 Hz to 1 MHz
> 1.2105 GHz to 1.818 GHz	0 Hz to 2 MHz
> 1.818 GHz to 2.655 GHz	0 Hz to 3 MHz
> 2.655 GHz to 3.300 GHz	0 Hz to 4 MHz
Setting accuracy (at AF = 1 kHz)	< 4% of reading + 20 Hz
FM distortion (at AF = 1 kHz and 50% of max. deviation)	
	< 0.2%, 0.1% typ.
Modulation frequency range (< 3 dB)	
standard	DC to 100 kHz
wide	10 Hz to 500 kHz
Incidental AM (at AF = 1 kHz, f > 10 MHz, 40 kHz deviation)	
	< 0.1%



Contents Overview

Chapter Overview

Type Index

R&amp;S Addresses



## Vector Signal Generator R&amp;S®SMV03

Stereo modulation at 40 kHz useful deviation, AF = 1 kHz, RF = 87 to 108 MHz	
Crosstalk	>50 dB
S/N ratio unweighted, rms	>70 dB
S/N ratio weighted, rms	>70 dB
Carrier frequency offset at FM DC	typ. 0.1% of set deviation
Modulation input EXT	1 V
<b>Phase modulation</b>	internal, external AC/DC, internal/external two-tone
Phase deviation <sup>9)</sup>	
9 kHz to 76 MHz	0 rad to 10 (2) rad
>76 MHz to 151.3125 MHz	0 rad to 1.25 (0.25) rad
>151.3125 MHz to 302.625 MHz	0 rad to 2.5 (0.5) rad
>302.625 MHz to 605.25 MHz	0 rad to 5 (1) rad
>605.25 MHz to 1.2105 GHz	0 rad to 10 (2) rad
>1.2105 GHz to 1.818 GHz	0 rad to 20 (4) rad
>1.818 GHz to 2.655 GHz	0 rad to 30 (6) rad
>2.655 GHz to 3.300 GHz	0 rad to 40 (8) rad
Modulation frequency range (–3 dB) standard	DC to 100 kHz
wide	10 Hz to 500 kHz
Resolution	<1%, min. 0.001 rad
Setting accuracy at AF = 1 kHz	<4% of reading + 0.02 rad
Phase distortion (at AF = 1 kHz and 50% of maximum deviation)	<0.2%, typ. 0.1%
<b>Pulse modulation (option SML-B3)</b>	internal, external
On/off ratio	>90 dB
Rise/fall time (10%/90%)	<20 ns, typ. 10 ns
Pulse repetition frequency	0 Hz to 2.5 MHz
Pulse delay	typ. 50 ns
Video crosstalk (V <sub>o</sub> )	<30 mV
<b>Pulse generator (option SML-B3)</b>	automatic, externally triggered, external gate mode, single pulse, double pulse, delayed pulse (externally triggered)
Active trigger edge	positive or negative
Pulse period/resolution/accuracy	100 ns to 85 s/5 digits/<1 × 10 <sup>-4</sup>
Pulse width/resolution/accuracy	20 ns to 1 s/4 digits/<1 × 10 <sup>-4</sup> + 3 ns
Pulse delay/resolution/accuracy	20 ns to 1 s/4 digits/<1 × 10 <sup>-4</sup> + 3 ns
Double-pulse spacing/resol./accuracy	20 ns to 1 s/4 digits/<1 × 10 <sup>-4</sup> + 3 ns
Trigger delay	typ. 50 ns
Jitter	<10 ns
<b>Stereo/RDS Coder (with option R&amp;S®SML-B5)</b>	
The specifications apply to RF frequencies in the range 66 MHz to 110 MHz.	
Stereo modes	
Internal with modulation generator	L, R, R = L, R = –L
External analog (via L and R inputs) or external digital (via S/P DIF input)	L, R, R = L, R = –L, R ≠ L
	internal generation of ARI/RDS signals, 5 user-selectable RDS data sets, simultaneous generation of MPX, ARI and RDS signals possible
MPX frequency deviation	0 Hz to 80 kHz
L, R signal	
AF frequency range	20 Hz to 15 kHz
AF frequency response (referenced to 500 Hz, 40 Hz to 15 kHz)	<0.2 dB
Stereo crosstalk attenuation (1 kHz)	>50 dB
Distortion (at 67.5 kHz MPX frequency deviation, AF = 1 kHz)	<0.1%, typ. 0.05%
S/N ratio <sup>10)</sup> (stereo/RDS signal)	
ITU-R weighted (quasi-peak)	>60 dB, typ. 63 dB
ITU-R unweighted (rms)	>70 dB, typ. 74 dB
A-weighted (rms)	>70 dB, typ. 76 dB.
Preemphasis	off, 50 μs, 75 μs

Pilot tone	
Frequency	19 kHz ±2 Hz
Deviation	0 Hz to 10 kHz
Phase (relative to 38 kHz phase)	0° to ±5°
ARI/RDS subcarrier frequency	57 kHz ±6 Hz
ARI frequency deviation	0 Hz to 10 kHz
RDS frequency deviation	0 Hz to 10 kHz
ARI/RDS	functions (directly selectable by menu or remote control)
ARI identification	selection of traffic announcement identification (DK) or area identification (BK), OFF, DK, BK, DK + BK
ARI BK	selection of standardized area identification A to F
RDS traffic program	traffic program off/on
RDS traffic announcement	traffic announcement off/on
RDS data set	selection of RDS data set 1 to 5
Maximum data length	64 kByte, can be loaded via IEC60625 or RS-232-C interface

- 1) With option R&S®SML-B3 only for f > 20 MHz.
- 2) With Attenuator Mode Auto.
- 3) Temperature range 20°C to 30°C.
- 4) With Attenuator Mode Fixed.
- 5) After 1 hour warm-up and recalibration within 4 hours of operation after temperature variations <5°C.
- 6) With Attenuator Mode Auto, f ≥ 100 kHz.
- 7) R&S®SML02, R&S®SML03: +5 dBm to 11 dBm at f ≤ 5 MHz, f > 3 GHz.
- 8) With option R&S®SML-B3 only for f > 10 MHz.
- 9) Values in brackets apply to wide modulation bandwidth.
- 10) Generator without preemphasis, receiver with deemphasis.

## General data

Memory for device settings	100 storable settings
Remote control	IEC625 (IEEE 488) and RS-232-C
Rated temperature range	0°C to 55°C;
Power supply	100 V to 120 V (AC), 50 Hz to 400 Hz, 200 V to 240 V (AC), 50 Hz to 60 Hz, autoranging, max. 250 VA
Dimensions (W × H × D)	427 mm × 88 mm × 450 mm
Weight	9.5 kg when fully equipped

## Ordering information

<b>Vector Signal Generator</b>	R&S®SMV03	1147.7509.13
Accessories supplied	power cable, user manual	
<b>Options</b>		
Reference Oscillator OCXO	R&S®SML-B1	1090.5790.02
Pulse Modulator	R&S®SML-B3	1090.5403.02 <sup>1)</sup>
Stereo /RDS Coder	R&S®SML-B5	1147.8805.02
Rear Connectors for AF, RF	R&S®SML-B19	1090.5303.02 <sup>1)</sup>
<b>Extras</b>		
Service Kit	R&S®SML-Z2	1090.5203.02
19" Rack Adapter	R&S®ZZA-211	1096.3260.00
Transport Bag	R&S®ZZT-214	1109.5119.00
Service Manual, Modules		1090.3123.24

- 1) Factory-fitted only.



Contents Overview

Chapter Overview

Type Index

R&amp;S Addresses





Contents Overview

Chapter Overview

Type Index

R&S Addresses



## Signal Generator R&S®SMT

R&S® SMT02: 5 kHz to 1.5 GHz

R&S® SMT03: 5 kHz to 3 GHz

R&S® SMT06: 5 kHz to 6 GHz

For receiver and EMS

measurements

Signal Generator R&S®SMT

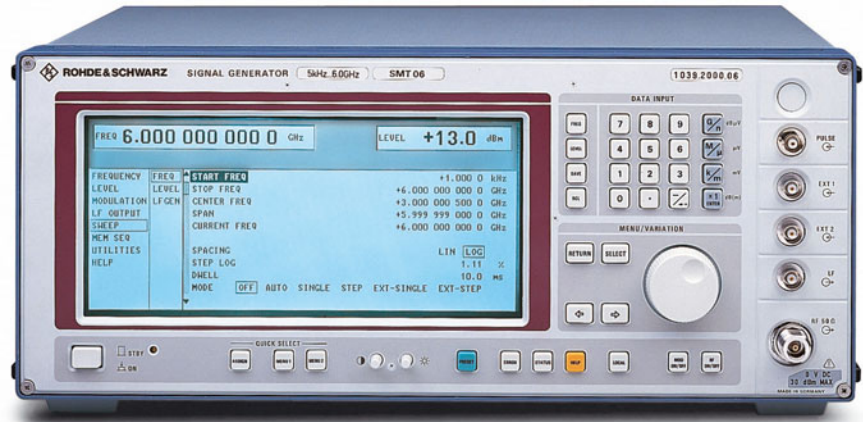

### Brief description

Signal Generator R&S®SMT covers the complete range of conventional analog receiver measurements. It provides an exceptionally high signal quality for a generator in this price category, as well as outstanding level accuracy, a wide variety of modulation and signal generation modes, customized configuration, and great ease of operation. Features such as programmable RF, LF and level sweeps as well as the correction of external frequency response make the R&S®SMT an ideal source for EMS measurements.

### Main features

- ◆ Ideal EMS signal source with specified frequency range from 5 kHz
- ◆ AM, FM, φM, pulse modulation
- ◆ FM DC with high carrier frequency accuracy
- ◆ Broadband FM from DC to 8 MHz, broadband φM from DC to 2 MHz

- ◆ Convenient RF/LF/level sweep
- ◆ Programmable level correction (compensation of external frequency response)
- ◆ VOR/ILS generator (option R&S®SM-B6)
  - phase resolution 0.01°
  - DDM resolution 0.0001
- ◆ Stereo generator (option R&S®SM-B6) for measurements on FM sound broadcast transmitters and receivers
- ◆ Large, backlit LCD for clear display of all relevant settings
- ◆ Minimum RF leakage due to special shielding measures
- ◆ Calibration interval of three years

### Overview of options

Designation, functions	Option
<b>Reference Oscillator OCX0:</b> aging $<1 \times 10^{-9}$ /day	R&S®SM-B1
<b>LF Generator:</b> supplies sinewave, noise 0.1 Hz to 500 kHz, triangular, squarewave 0.1 Hz to 50 kHz signals	R&S®SM-B2
<b>Pulse Modulator:</b> on/off ratio >80 dB, rise/fall time <10 ns	R&S®SMT02: R&S®SM-B3 R&S®SMT03: R&S®SM-B8 R&S®SMT06: R&S®SM-B9
<b>Pulse Generator:</b> only in conjunction with R&S®SM-B3/R&S®SM-B8/R&S®SM-B9; provides single, delayed and double pulses	R&S®SM-B4
<b>Multifunction Generator:</b> produces stereo multiplex and VOR/ILS signals as well as sinewave, noise 0.1 Hz to 1 MHz, triangular, sawtooth, squarewave 0.1 Hz to 50 kHz signals	R&S®SM-B6
<b>Rear Connectors for RF and LF:</b> to replace front-panel connectors	R&S®SMT-B19



Contents Overview

Chapter Overview

Type Index

R&S Addresses





Contents Overview

Chapter Overview

Type Index

R&amp;S Addresses



## Signal Generator R&amp;S® SMT

## Specifications in brief

You will find detailed and binding data on the enclosed CD (./DATASHEET/SMT.pdf), or, for the latest updates, visit [www.rohde-schwarz.com](http://www.rohde-schwarz.com), search term: SMT

Frequency	
Range R&S® SMT02/03/06	5 kHz to 1.5/3/6 GHz
Phase offset	adjustable in 1° steps
Spectral purity	
Spurious signals	
Harmonics	<-30 dBc, with R&S® SM-B8/-B9: <-26 dBc
Nonharmonics (f < 1.5 GHz)	<-80 dBc
SSB phase noise at 20 kHz from carrier, 1 Hz bandwidth	
<67.5 MHz/125 MHz	<-120 dBc/<-134 dBc
250 MHz/500 MHz	<-128 dBc/<-122 dBc
1000 MHz/2000 MHz	<-116 dBc/<-110 dBc
3000 MHz/6000 MHz	<-109 dBc/<-103 dBc
Level	-144 to +13 dBm
Accuracy for levels >=127 dBm	
f < 1.5 GHz	±1 dB
Level frequency response at 0 dBm	1 dB, typ. 0.3 dB
Simultaneous modulation	
	any combination of AM, FM (φM) and pulse modulation
Amplitude modulation	
	internal, external AC/DC
Modulation depth	0% to 100%
AM distortion at 1 kHz, m=30%	<1%
Modulation frequency range	DC to 100 kHz
Frequency modulation	
	internal, external AC/DC, two-tone with two separate channels FM1 and FM2
Maximum deviation	depending on carrier frequency: 5 MHz (at f <sub>c</sub> < 130 MHz) to 40 MHz (at f <sub>c</sub> 6 GHz)
FM distortion at AF=1 kHz and 50% of max. deviation	typ. 0.1%
Modulation frequency response	
20 Hz (DC) to 100 kHz	0.5 dB
Stereo modulation	
Crosstalk attenuation	>50 dB
Unweighted S/N ratio	>76 dB
Carrier frequency offset (FM DC)	<0.1% of deviation
Phase modulation	
	internal, external AC/DC, two-tone with two separate channels broadband φM or narrowband φM (broadband φM only possible with φM2)
Maximum deviation	depending on carrier frequency
φM range 1: DC to 100 kHz	12.5 rad to 400 rad
φM range 2: DC to 2 MHz	0.625 rad to 20 rad
Pulse modulation	
	option R&S® SM-B3/-B8/-B9
Operating modes	external; internal with optional Pulse Generator R&S® SM-B4
On/off ratio	>80 dB
Rise/fall time (10%/90%)	<10 ns
Internal modulation generator	
	0.4/1/3/15 kHz ±3%
Level (EMF) at LF socket	1 V ±1% (R <sub>out</sub> =10 Ω, R <sub>L</sub> >200 Ω)
LF generator	
	option R&S® SM-B2
Sinewave, noise	0.1 Hz to 500 kHz
Triangular, squarewave	0.1 Hz to 50 kHz
Distortion (20 Hz to 100 kHz)	<0.1% (level >0.5 V)
Level (EMF) at LF socket	1 mV to 4 V (R <sub>out</sub> =10 Ω, R <sub>L</sub> >200 Ω)

<b>Multifunction generator</b>	option R&S® SM-B6
Modulation signals	sinewave, triangular, sawtooth, squarewave, noise, stereo MPX, VOR/ILS
Sinewave, noise	0.1 Hz to 1 MHz
Triangular, sawtooth, squarewave	0.1 Hz to 50 kHz
Distortion (20 Hz to 100 kHz)	<0.1% (level >0.5 V)
Level (EMF) at LF socket	1 mV to 4 V (R <sub>out</sub> =10 Ω, R <sub>L</sub> >200 Ω)
<b>Stereo multiplex signal</b>	with option R&S® SM-B6
Stereo operating modes	R, L, R=L, R=-L, ARI (pilot tone or MPX signal can be connected to LF socket)
Frequency range of L, R signal	0.1 Hz to 15 kHz
Preemphasis	50 μs, 75 μs
Pilot-tone frequency	19 kHz ±1 Hz
Pilot phase/resolution	0° to 360°/0.1°
<b>VOR modulation signal</b>	option R&S® SM-B6
Settings	30 Hz (VAR, REF)/ 9.96 kHz FM carrier, FM deviation, COM/ID tone
Phase/phase resolution	0° to 360°/0.01°
Bearing error (RF output, 108 MHz to 118 MHz)	<0.05°
<b>ILS modulation signal</b>	option R&S® SM-B6
Settings	90 Hz, 150 Hz tone, COM/ID tone, marker beacon
DDM setting range/resolution	0 to ±0.8/0.0001
DDM error (RF output)	
Localizer (108 MHz to 112 MHz)	<0.0004 + 1% of DDM reading
Glideslope (329 MHz to 335 MHz)	<0.0008 + 1% of DDM reading
<b>Pulse generator</b>	option R&S® SM-B4
Operating modes	single, delayed and double pulse
Pulse repetition period	100 ns to 85 s
Pulse width	20 ns to 1 s
Pulse delay	40 ns to 1 s
Double pulse	60 ns to 1 s
<b>Sweep</b>	
digital sweep	in discrete steps for RF, level and LF
LF sweep	option R&S® SM-B2 or R&S® SM-B6
General data	
Remote control	IEC625 (IEEE488)
Power supply	100 V to 240 V, 50 Hz to 400 Hz (300 VA)
Power consumption	max. 210 W (2.7 to 1.1 A)
Dimensions (W × H × D)	435 mm × 192 mm × 350 mm
Weight	20 kg for fully equipped unit

## Ordering information

<b>Signal Generator</b>	R&S® SMT02	1039.2000.02
	R&S® SMT03	1039.2000.03
	R&S® SMT06	1039.2000.06
<b>Options</b>		
Reference Oscillator OCXO	R&S® SM-B1	1036.7599.02
LF Generator	R&S® SM-B2	1036.7947.02
Pulse Modulator		
for R&S® SMT02	R&S® SM-B3	1036.6340.02
for R&S® SMT03	R&S® SM-B8	1036.6805.02
for R&S® SMT06	R&S® SM-B9	1039.5100.02
Pulse Generator (only in combination with R&S® SM-B3, -B8 or -B9)	R&S® SM-B4	1036.9310.02
Multifunction Generator	R&S® SM-B6	1036.7760.02
Rear Connectors for RF and LF	R&S® SMT-B19	1039.4003.02



Contents Overview

Chapter Overview

Type Index

R&amp;S Addresses





Contents Overview

Chapter Overview

Type Index

R&amp;S Addresses



## Signal Generator R&amp;S®SML

R&amp;S®SML01: 9 kHz to 1.1 GHz

R&amp;S®SML02: 9 kHz to 2.2 GHz

R&amp;S®SML03: 9 kHz to 3.3 GHz

Economy at its best

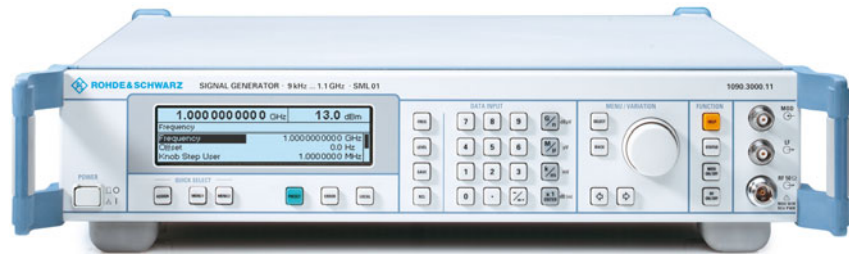

Signal Generator R&amp;S®SML01

## Brief description

R&S®SML offers all features required of a state-of-the-art general-purpose signal generator: wide frequency range, large variety of modulation functions and high reliability – at an extremely attractive price. The fields of application of R&S®SML are virtually unlimited in development, servicing or production where it is used as a flexible signal source in automatic test systems. R&S®SML benefits both from our long-standing experience in the field of signal generators and the latest technology. Its uses are as versatile as its functionalities.

## Main features

## Frequency

- ◆ 9 kHz to 1.1 GHz/2.2 GHz/3.3 GHz
- ◆ 0.1 Hz frequency resolution

## Level

- ◆ –140 dBm to +13 dBm (+19 dBm overrange)
- ◆ High level accuracy (deviation <0.5 dB)
- ◆ Level setting without overshoots
- ◆ Electronic attenuator
- ◆ Non-interrupting level setting

## Spectral purity

- ◆ SSB phase noise <–122 dBc (1 Hz), typ. <–128 dBc (1 Hz) (at carrier offset 20 kHz)

- ◆ Broadband noise <–140 dBc (1 Hz), typ. –150 dBc (1 Hz) (f = 1 GHz, carrier offset >2 MHz)

## Speed

- ◆ Setting times <10 ms for frequency and level

## Modulation

- ◆ AM/FM/φM as standard
- ◆ Simultaneous operation of AM, FM/φM and pulse modulation
- ◆ Optional pulse modulator with integrated pulse generator (R&S®SML-B3)

## Low cost of ownership

- ◆ 3-year calibration cycle
- ◆ Low purchase price
- ◆ High reliability through electronic attenuator (wear-free)
- ◆ Service-friendly (continuous selftest, access to internal test points via LCD)
- ◆ Options OCXO (R&S®SML-B1) and pulse modulator (R&S®SML-B3) retrofittable

## Size

- ◆ Compact size: 427 mm × 88 mm × 450 mm
- ◆ Low weight: <8 kg

## Applications

## The use of a signal generator in the laboratory requires

- ◆ Wide frequency range
- ◆ High spectral purity

- ◆ High and accurate output level
- ◆ Very good modulation characteristics

## These features are particularly important in servicing

- ◆ High mobility
- ◆ Flexible control
- ◆ Protection against overvoltage

## In production these factors play a vital role

- ◆ Accuracy for high yield
- ◆ Speed for high throughput
- ◆ Reliability for undisturbed operation

## EMS measurements require

- ◆ Non-interrupting level setting
- ◆ Level setting without overshoots
- ◆ Wide frequency range

## Stereo/RDS Coder R&amp;S®SML-B5 (option)

Fitted with the new option, the signal generators of the tried and tested R&S®SML and R&S®SMV families generate stereo-modulated RF signals to standard for use in production, development and service. At the core of this option is a digital signal processor (DSP) that generates stereo, RDS and ARI signals of outstanding quality, which is fully sustained owing to the excellent FM modulators in the generators.



Contents Overview

Chapter Overview

Type Index

R&amp;S Addresses



## User-friendly operation

- ◆ One-hand operation with EasyWheel
- ◆ All settings simple and self-explanatory
- ◆ High-contrast LC display
- ◆ User-assignable menu keys
- ◆ Online help including IEC/IEEE-bus commands

## Specifications in brief

You will find detailed and binding data on the enclosed CD (./DATASHEET/SML.pdf), or, for the latest updates, visit [www.rohde-schwarz.com](http://www.rohde-schwarz.com), search term: SML

Frequency	
Range	9 kHz to 1.1 GHz
R&S®SML01	9 kHz to 1.1 GHz
R&S®SML02	9 kHz to 2.2 GHz
R&S®SML03	9 kHz to 3.3 GHz
Resolution	0.1 Hz
Setting time (for an offset of $<1 \times 10^{-7}$ or $<90$ Hz for $f \leq 76$ MHz)	$<10$ ms
Spectral purity	
Spurious signals	
Harmonics <sup>1)</sup>	
R&S®SML01	$<-30$ dBc at levels $\leq +10$ dBm
R&S®SML02/R&S®SML03	
$f \leq 20$ kHz	$<-25$ dBc at levels $\leq +8$ dBm
$f > 20$ kHz	$<-30$ dBc at levels $\leq +8$ dBm
Subharmonics	
$f \leq 1.1$ GHz	none
$f > 1.1$ GHz	$<-50$ dBc
Nonharmonics	$<-70$ dBc
(carrier offset $> 10$ kHz)	
$f \leq 1.1$ GHz	$<-70$ dBc
$f > 1.1$ GHz to 2.2 GHz	$<-64$ dBc
$f > 2.2$ GHz to 3.3 GHz	$<-58$ dBc
Broadband noise <sup>4)</sup> ( $f = 1$ GHz, carrier offset $> 2$ MHz, 1 Hz bandwidth)	$<-140$ dBc, typ. $-150$ dBc
SSB noise ( $f = 1$ GHz, 20 kHz carrier offset, 1 Hz bandwidth)	$<-122$ dBc, typ. $-128$ dBc
Spurious FM, rms ( $f = 1$ GHz)	
0.3 kHz to 3 kHz	$<4$ Hz, typ. 1 Hz
0.03 kHz to 20 kHz	$<10$ Hz, typ. 3 Hz
Spurious AM, rms (0.03 kHz to 20 kHz)	$<0.02\%$
Level	
Range	$-140$ dBm to $+13$ dBm <sup>3)</sup> (overrange $+19$ dBm)
Resolution	0.1 dB
Total level deviation <sup>3)</sup> output $>-120$ dBm	
R&S®SML01	$<0.5$ dB
R&S®SML02/R&S®SML03	
100 kHz to $\leq 2$ GHz	$<0.5$ dB
$f > 2$ GHz	$<0.9$ dB
Frequency response at 0 dBm <sup>3)</sup>	
R&S®SML01	$<0.5$ dB, typ. 0.3 dB
R&S®SML02/R&S®SML03	
100 kHz to $\leq 2$ GHz	$<0.7$ dB
$f > 2$ GHz	$<1.0$ dB
VSWR R&S®SML01	$<1.5$
VSWR R&S®SML02/03	
100kHz to 1.5 GHz	1.6
$f > 1.5$ GHz	2.3
Setting time (IEC/IEEE bus), $f > 100$ kHz	$<10$ ms, typ. 5 ms
Non-interrupting level setting <sup>4)</sup>	20 dB, overrange 30 dB

<b>Overvoltage protection</b>	safeguards unit against externally applied RF power and DC voltage (50 $\Omega$ source)
Max. permissible RF power $f \leq 2.2$ GHz	50 W
Max. permissible RF power $f > 2.2$ GHz	25 W
Max. permissible DC voltage	35 V
Internal modulation generator	
Frequency range	0.1 Hz to 1 MHz
Frequency response (up to 500 kHz, level $>100$ mV)	$<0.5$ dB
THD (up to 100 kHz, level 4 V, 600 $\Omega$ )	$<0.1\%$
Open-circuit voltage $V_o$ (LF connector)	1 mV to 4 V
Frequency setting time	$<10$ ms
<b>Simultaneous modulation</b>	AM, FM/ $\phi$ M and pulse modulation
Amplitude modulation <sup>3)</sup>	
Operating modes	internal, external AC/DC, internal/external two-tone
Modulation depth	0% to 100%
AM distortion at 1 kHz, $m = 30\%$	$<1\%$
Modulation frequency range (3 dB), $f > 100$ kHz	DC/10 Hz to 50 kHz
Frequency modulation	
Operating modes	internal, external AC/DC, internal/external two-tone
Frequency deviation	
9 kHz to 76 MHz	0 Hz to 1 MHz
$>76$ MHz to 151.3125 MHz	0 Hz to 125 kHz
$>151.3125$ MHz to 302.625 MHz	0 Hz to 250 kHz
$>302.625$ MHz to 605.25 MHz	0 Hz to 500 kHz
$>605.25$ MHz to 1.2105 GHz	0 Hz to 1 MHz
$>1.2105$ GHz to 1.818 GHz	0 Hz to 2 MHz
$>1.818$ GHz to 2.655 GHz	0 Hz to 3 MHz
$>2.655$ GHz to 3.300 GHz	0 Hz to 4 MHz
FM distortion (at AF = 1 kHz and 50% of max. deviation)	$<0.2\%$ , typ. 0.1 %
Modulation frequency range ( $-3$ dB), standard/wide	DC/10 Hz to 100 kHz/500 kHz
Stereo modulation at 40 kHz useful deviation, AF = 1 kHz, RF = 87 to 108 MHz	
Crosstalk	$>50$ dB
S/N ratio unweighted, rms	$>70$ dB
S/N ratio weighted, rms	$>70$ dB
Distortion	typ. 0.1 %
Carrier frequency offset at FM DC	typ. 0.1% of set deviation
Phase modulation	
Operating modes	internal, external AC/DC, internal/external two-tone
Phase deviation <sup>1)</sup>	
9 kHz to 76 MHz	0 rad to 10 (2) rad
$>76$ MHz to 151.3125 MHz	0 rad to 1.25 (0.25) rad
$>151.3125$ MHz to 302.625 MHz	0 rad to 2.5 (0.5) rad
$>302.625$ MHz to 605.25 MHz	0 rad to 5 (1) rad
$>605.25$ MHz to 1.2105 GHz	0 rad to 10 (2) rad
$>1.2105$ GHz to 1.818 GHz	0 rad to 20 (4) rad
$>1.818$ GHz to 2.655 GHz	0 rad to 30 (6) rad
$>2.655$ GHz to 3.300 GHz	0 rad to 40 (8) rad
Modulation frequency range ( $-3$ dB), standard/wide	DC/10 Hz to 100 kHz/500 kHz



Contents Overview

Chapter Overview

Type Index

R&amp;S Addresses



## Signal Generator R&amp;S®SML

<b>Pulse modulation (with option R&amp;S®SML-B3)</b>	
Operating modes	internal, external
On/off ratio	>90 dB
Rise/fall time (10%/90%)	<20 ns, typ. 10 ns
Pulse repetition frequency	0 Hz to 2.5 MHz
Pulse delay	typ. 50 ns
<b>Pulse generator (with option R&amp;S®SML-B3)</b>	
Operating modes	automatic, externally triggered, external gate mode, single pulse, double pulse, delayed pulse (externally triggered)
Active trigger edge	positive or negative
Pulse period	100 ns to 85 s
Pulse width	20 ns to 1 s
Pulse delay	20 ns to 1 s
Double-pulse spacing	20 ns to 1 s
Trigger delay	typ. 50 ns
<b>Sweep</b>	digital in discrete steps
RF sweep, AF sweep	
Operating modes	automatic, single shot, manually or externally triggered, linear or logarithmic
Sweep range	user-selectable
Step width (lin)	user-selectable
Step width (log)	0.01% to 100%
Level sweep	
Operating modes	automatic, single-shot, manually or externally triggered, logarithmic
Sweep range	user-selectable
Step width (log)	user-selectable
Step time	10 ms to 1 s
Resolution	0.1 ms
<b>Stereo/RDS Coder (with option R&amp;S®SML-B5)</b>	
The specifications apply to RF frequencies in the range 66 MHz to 110 MHz.	
Stereo modes	
Internal with modulation generator	L, R, R = L, R = -L
External analog (via L and R inputs) or external digital (via S/P DIF input)	L, R, R = L, R = -L, R ≠ L
	internal generation of ARI/RDS signals, 5 user-selectable RDS data sets, simultaneous generation of MPX, ARI and RDS signals possible
MPX frequency deviation	0 Hz to 80 kHz
L, R signal	
AF frequency range	20 Hz to 15 kHz
AF frequency response (referenced to 500 Hz, 40 Hz to 15 kHz)	<0.2 dB
Stereo crosstalk attenuation (1 kHz)	>50 dB
Distortion (at 67.5 kHz MPX frequency deviation, AF = 1 kHz)	<0.1%, typ. 0.05%
S/N ratio <sup>1)</sup> (stereo/RDS signal)	
ITU-R weighted (quasi-peak)	>60 dB, typ. 63 dB
ITU-R unweighted (rms)	>70 dB, typ. 74 dB
A-weighted (rms)	>70 dB, typ. 76 dB
Preemphasis	off, 50 μs, 75 μs
Pilot tone	
Frequency	19 kHz ±2 Hz
Deviation	0 Hz to 10 kHz
Phase (relative to 38 kHz phase)	0° to ±5°
ARI/RDS subcarrier frequency	57 kHz ±6 Hz
ARI frequency deviation	0 Hz to 10 kHz
RDS frequency deviation	0 Hz to 10 kHz

ARI/RDS	functions (directly selectable by menu or remote control)
ARI identification	selection of traffic announcement identification (DK) or area identification (BK), OFF, DK, BK, DK + BK
ARI BK	selection of standardized area identification A to F
RDS traffic program	traffic program off/on
RDS traffic announcement	traffic announcement off/on
RDS data set	selection of RDS data set 1 to 5
Maximum data length	64 kByte, can be loaded via IEC60625 or RS-232-C interface

1) Generator without preemphasis, receiver with deemphasis.

## General data

Memory for device settings	100 storable settings
Remote control	IEC625 (IEEE488) and RS-232-C
Nominal temperature range	0°C and 55°C
Power supply	100 V to 120 V (AC), 50 Hz to 60 Hz, 200 V to 240 V (AC), 50 Hz to 60 Hz, autoranging, max. 150 VA
Dimensions (W × H × D)	427 mm × 88 mm × 450 mm
Weight	<8 kg when fully equipped

## Ordering information

<b>Signal Generator</b>	R&S®SML01	1090.3000.11
	R&S®SML02	1090.3000.12
	R&S®SML03	1090.3000.13
<b>Accessories supplied</b>	power cable, user manual	
<b>Options</b>		
Reference Oscillator OCXO	R&S®SML-B1	1090.5790.02
Pulse Modulator	R&S®SML-B3	1090.5403.02 <sup>8)</sup>
Stereo/RDS Coder	R&S®SML-B5	1147.8805.02
Rear Connectors for AF, RF	R&S®SML-B19	1090.5303.02 <sup>8)</sup>
<b>Extras</b>		
Service Kit	R&S®SML-Z2	1090.5203.02
19" Rack Adapter	R&S®ZZA-211	1096.3260.00
Transport Bag	R&S®ZZT-214	1109.5119.00
Service Manual Modules		1090.3123.24

1) With option R&S®SML-B3 only for f >20 MHz.

2) With Attenuator Mode Auto.

3) R&S®SML02, R&S®SML03: +11 dBm at f ≤5MHz, f >3GHz.

4) With Attenuator Mode Fixed.

5) With Attenuator Mode Auto, f ≥100 kHz.

6) With option R&S®SML-B3 only for f >10 MHz.

7) Values in brackets apply to wide modulation bandwidth.

8) Factory-fitted only.



Contents Overview

Chapter Overview

Type Index

R&amp;S Addresses





## RF Signal Generator R&S®SM300

9 kHz to 3 GHz

Professional signal generator for  
production, laboratory and service

**New**



### Brief description

The R&S®SM300 is a favourably priced signal generator for applications in the 9 kHz to 3 GHz frequency range. The instrument features a broad scope of functions, outstanding technical characteristics and compact design.

The R&S®SM300 offers an immense range of applications — whether on the lab bench, in service or as a flexible measuring instrument in automatic production systems.

### Applications

- ◆ Generation of precise test signals for the following applications: lab, service, production and quality assurance
- ◆ Provision of digitally modulated signals in the 9 kHz to 3 GHz frequency range (e.g. with the R&S®AM300 as an external baseband signal source)
- ◆ Signal generation and modulation (AM, pulse) for EMC measurements of components (EMS)
- ◆ Functionality testing of components in production

### Main features

- ◆ High signal quality
- ◆ Internal I/Q modulator
  - High I/Q bandwidth for W-LAN measurements in accordance with IEEE802.11b and IEEE802.11g
  - Generation of WCDMA test signals for measuring ACLR, EVM and code domain power
  - Generation of GSM signals for measuring phase error
- ◆ All analog modulation modes
- ◆ Frequency sweep, level sweep
- ◆ High level accuracy
- ◆ Internal pulse generator
- ◆ Semi-automatic measurements by pressing a button to retrieve stored settings
- ◆ USB remote control

### Characteristics

In addition to standard analog modulation modes, external I/Q signals can be fed in for RF signal modulation. Digitally modulated signals can thus be generated, as required in mobile radio, for example.

The internal LF generator (20 Hz to 80 kHz) and the wide range of analog modulation modes such as AM, FM,  $\phi$ M, and pulse make the R&S®SM300 a universal signal source. In addition, the built-in square wave generator and pulse modulator can generate bursts.

An innovation in this price category is the capability to modulate the output signal by means of analog I/Q signals (as generated by the Dual-Channel Arbitrary/Function Generator R&S®AM300, for example) in order to generate almost any signal. The I/Q modulator bandwidth of 40 MHz is fully sufficient for all common wireless transmission methods such as GSM, WCDMA and WLAN.

Operation is menu-guided so that even untrained users will quickly obtain correct results. Clear structures simplify navigation within the menus. The bright TFT colour display with 320 × 240 pixel resolution allows traces to be read even at odd angles or when the incidence of light is unfavourable.



Contents Overview

Chapter Overview

Type Index

R&amp;S Addresses



## RF Signal Generator R&amp;S®SM300

## Specifications in brief

You will find detailed and binding data on the enclosed CD (./DATASHEET/SM300.pdf), or, for the latest updates, visit [www.rohde-schwarz.com](http://www.rohde-schwarz.com), search term: SM300

RF frequency	
Frequency range	9 kHz to 3 GHz
Resolution	0.1 Hz
Setting time	<10 ms
Spectral purity	
Spurious	
Harmonics (level $\leq 0$ dBm, $f_c > 1$ MHz)	<-30 dBc
Nonharmonics (>10 kHz from carrier)	<-50 dBc
Wideband noise (carrier offset >2 MHz, $f_c = 1$ GHz)	<-123 dBc (1 Hz)
Single-sideband phase noise (carrier offset 20 kHz, $f_c = 1$ GHz)	<-95 dBc (1 Hz)
Residual FM (rms, $f_c = 1$ GHz)	
0.3 Hz to 3 kHz	<10 Hz
.03 kHz to 20 kHz	<60 Hz
Residual AM (rms, $f_c = 1$ GHz)	
0.3 kHz to 3 kHz	<0.03%
RF level	
Level range	-127 dBm to +13 dBm
Setting time	<10 ms
Setting resolution	0.1 dB
Level uncertainty (level >-120 dBm, 20°C to 30°C)	<1 dB
LF generator	
Frequency range	20 Hz to 80 kHz
Frequency setting resolution	0.1 Hz
Frequency response (20 Hz to 20 kHz)	<0.2 dB
Total harmonic distortion (20 Hz to 20 kHz)	<0.1%
Modulation	
Amplitude modulation	
Operating modes	internal, external AC/DC
Modulation depth	0% to 100%
Resolution	0.1%
Setting uncertainty ( $f_{LF} = 1$ kHz, $m < 80\%$ , level $\leq 0$ dBm)	<5% + 0.07%
AM total harmonic distortion ( $f_{LF} = 1$ kHz, $m < 80\%$ , level $\leq 0$ dBm)	<2%
Modulation frequency range	DC/20 Hz to 20 kHz
Frequency modulation	
Operating modes	internal, external AC/DC
Frequency deviation	20 Hz to 100 kHz
Resolution	<1%
Setting uncertainty ( $f_{LF} = 1$ kHz)	<5% + residual FM
FM total harmonic distortion ( $f_{LF} = 1$ kHz, deviation = 50 kHz)	<1%
Modulation frequency range	DC/20 Hz to 80 kHz
Phase modulation	
Operating modes	internal
Phase deviation	
$f_{LF} \leq 10$ kHz	0 to 10 rad
10 kHz < $f_{LF} \leq 20$ kHz	0 to 5 rad
Resolution	<1%, min. 0.001 rad

Setting uncertainty ( $f_{LF} = 1$ kHz)	<5% + 0.02 rad
$\phi$ M total harmonic distortion ( $f_{LF} = 1$ kHz, deviation = 5 rad)	<1.5%
Modulation frequency range	300 Hz to 20 kHz
I/Q modulation	
Operating modes	external
Modulation frequency range (3 dB)	DC to 40 MHz
Carrier suppression ( $f_c = 1.8$ GHz)	typ. -40 dBc
ACLR WCDMA 3GPP FDD	Test model 1
Offset 5 MHz	typ. -54 dBc
Offset 10 MHz	typ. -55 dBc
Composite EVM (64 DPCH channels)	typ. 3.3%
Generation of GSM signals	
Phase error	typ. 1.2° rms
Pulse modulation/pulse generator	
Operating modes	external, internal
Rise/fall time (10%/90%)	<500 ns
Delay time (external)	100 $\mu$ s to 1 s
Pulse width (internal, external)	100 $\mu$ s to 1 s
Pulse period (internal)	200 $\mu$ s to 2 s
Time resolution	1 $\mu$ s
Sweep	
RF sweep, LF sweep	
Operating modes	continuous sweep, single sweep, single step
Sweep range RF (LF 20 Hz to 80 kHz)	9 kHz to 3 GHz,
Step width (log)	0.01% to 100%
Step width (lin) RF (LF 0.1 Hz to 80 kHz)	0.1 Hz to 1 GHz
Level sweep	
Operating modes	continuous sweep, single sweep, single step
Sweep range	-127 dBm to 13 dBm
Step width	1 dB to 20 dB
Step time	10 ms to 1 s
Interfaces	
USB host	Connector A plug, protocol version 1.1
Command set	Device-specific, remote control via supplied Windows driver (Windows XP, 2000)
USB device	Connector B plug, protocol version 1.1
Power supply	
Input voltage range	100 V to 240 V (AC), 50 Hz to 60 Hz, autoranging
Power consumption	<35 VA
General data	
Display	5.4" active colour TFT display
Resolution	320 x 240 pixel
Memory locations	10 device setups
Operating temperature range	+5°C to +45°C
Dimensions (W x H x D)	219 mm x 147 mm x 350 mm
Weight approx.	7 kg

## Ordering information

RF Signal Generator	R&S®SM300	1147.1498.03
Recommended extra		
Rack Adapter	R&S®ZZA-300	1147.1281.00
Carrying Case		on request



Contents Overview

Chapter Overview

Type Index

R&amp;S Addresses





## Microwave Signal Generator R&S®SMP

### R&S®SMP02/22:

0.01/2 GHz to 20 GHz

R&S®SMP03: 0.01/2 GHz to 27 GHz

R&S®SMP04: 0.01/2 GHz to 40 GHz

Excellent signal characteristics and high output power up to 40 GHz

*Microwave Signal Generator R&S®SMP04*

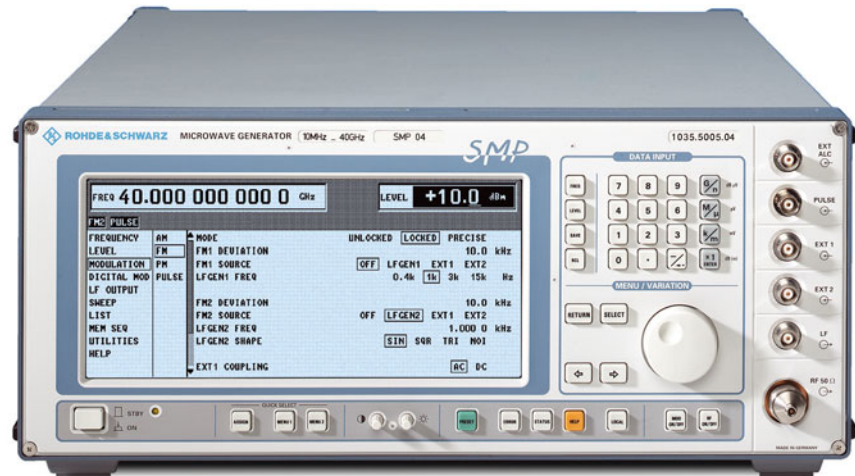

### Brief description

The Microwave Signal Generator R&S®SMP is a reliable, high-precision signal source featuring high output power, high spectral purity and excellent pulse modulation. It is able to supply signals for any measurements on radar and communications receivers. A wide range of extensions ensures universal use in R&D, production, EMC and environmental measurements as well as in material testing.

The R&S®SMP is ideal for the following applications:

- ◆ Substitution of local oscillators
- ◆ Measurements on nonlinear components such as frequency multipliers or high-level mixers
- ◆ Driving of travelling wave tubes (TWTs) and other power stages, e.g. for EMC applications
- ◆ Interconnection of several signal generators for intermodulation measurements
- ◆ Tracking generator for spectrum and network analyzers

### Overview of options

Designation, functions	Option
<b>Reference Oscillator OCXO:</b> aging $<1 \times 10^{-7}$ /year	R&S®SMP-B1
<b>LF Generator:</b> supplies sinewave, noise 0.1 Hz to 500 kHz, triangular, squarewave 0.1 Hz to 50 kHz signals	R&S®SM-B2
<b>FM/φM Modulator:</b> FM DC to 1 MHz, φM DC to 100 kHz, precision FM DC	R&S®SM-B5
<b>Frequency Extension 0.01 GHz to 2 GHz<sup>1)</sup>:</b> extends the lower frequency limit to 10 MHz	R&S®SMP-B11
<b>Pulse Modulator 2 GHz to 20 GHz<sup>1)</sup>:</b> on/off ratio >80 dB, rise/fall time <10 ns; for R&S®SMP02 and R&S®SMP22 only	R&S®SMP-B12, model .02
<b>Pulse Modulator 2 GHz to 27 GHz<sup>1)</sup>:</b> on/off ratio >80 dB, rise/fall time <10 ns; for R&S®SMP03 only	R&S®SMP-B12, model .03
<b>Pulse Modulator 2 GHz to 40 GHz<sup>1)</sup>:</b> on/off ratio >80 dB, rise/fall time <10 ns; for R&S®SMP04 only	R&S®SMP-B12, model .04
<b>Pulse Modulator 0.01 GHz to 2 GHz<sup>1)</sup>:</b> on/off ratio >80 dB, rise/fall time <10 ns	R&S®SMP-B13
<b>Pulse Generator:</b> provides single, delayed and double pulses	R&S®SMP-B14
<b>RF Attenuator 27 GHz<sup>1)</sup>:</b> allows level setting down to -130 dBm; for R&S®SMP02, R&S®SMP22 and R&S®SMP03 only	R&S®SMP-B15
<b>RF Attenuator 40 GHz<sup>1)</sup>:</b> allows level setting down to -130 dBm; for R&S®SMP04 only	R&S®SMP-B17
<b>Auxiliary Interface:</b> V/GHz output, Z output for scalar network analyzers	R&S®SMP-B18
<b>Rear Connectors for RF and AF<sup>1)</sup>:</b> to replace front-panel connectors; for R&S®SMP02, R&S®SMP22 and R&S®SMP03 only	R&S®SMP-B19
<b>Rear Connectors for RF and AF<sup>1)</sup>:</b> to replace front-panel connectors; for R&S®SMP04 only	R&S®SMP-B20

1) Factory-fitted option.



## Main features

- ◆ Instrument family with four models
  - R&S®SMP02 (10 MHz to 20 GHz)
  - R&S®SMP22 (10 MHz to 20 GHz)
  - R&S®SMP03 (10 MHz to 27 GHz)
  - R&S®SMP04 (10 MHz to 40 GHz)
- ◆ High output level
  - R&S®SMP02 >+11.5 dBm
  - R&S®SMP22 >+20 dBm (typ. +29 dBm at 2 GHz)
  - R&S®SMP03 >+13 dBm
  - R&S®SMP04 >+10 dBm
- ◆ Optional pulse modulator and pulse generator
- ◆ Digital RF, AF and level sweep
- ◆ Storage of 50 complete instrument setups
- ◆ Optional phase modulator

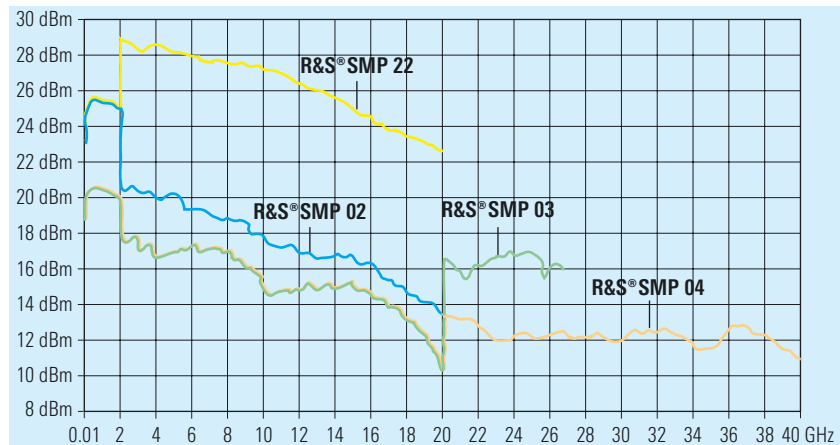

Typical maximum level versus frequency

- ◆ ASK/FSK modulation, phase offset settings
- ◆ Extremely low SSB phase noise at 10 GHz (<-105 dBc (1 Hz) at 10 kHz from carrier)
- ◆ Very short frequency setting time <11 ms + 5 ms/GHz
- ◆ Extremely high level accuracy <±0.9 dB at 0 dBm in frequency range 10 MHz to 40 GHz

## Specifications in brief

You will find detailed and binding data on the enclosed CD (./DATASHEET/R&S®SMP.pdf), or, for the latest updates, visit [www.rohde-schwarz.com](http://www.rohde-schwarz.com), search term: R&S®SMP

### Frequency

Range (standard)	
R&S®SMP02/R&S®SMP22	2 GHz to 20 GHz
R&S®SMP03	2 GHz to 27 GHz
R&S®SMP04	2 GHz to 40 GHz
Range (with option R&S®SMP-B11)	
R&S®SMP02/R&S®SMP22	10 MHz to 20 GHz
R&S®SMP03	10 MHz to 27 GHz
R&S®SMP04	10 MHz to 40 GHz
Resolution	0.1 Hz
Setting time (to within $<1 \times 10^{-9}$ ) after IEC/IEEE-bus delimiter	<(11 ms + 5 ms/GHz) <sup>1</sup>
Phase offset	adjustable in 1° steps

### Spectral purity

Spurious signals	R&S®SMP02	R&S®SMP22	R&S®SMP03	R&S®SMP04
Harmonics				
f < 1.8 GHz	<-30 dBc	<-25 dBc	<-30 dBc	<-30 dBc
f ≥ 1.8 GHz	<-40 dBc	<-25 dBc	<-40 dBc	<-40 dBc
Harmonics (with options R&S®SMP-B12/-B13, pulse modulation on)				
f < 1.8 GHz	<-25 dBc	<-25 dBc	<-25 dBc	<-25 dBc
f ≥ 1.8 GHz	<-25 dBc	<-25 dBc	<-25 dBc	<-25 dBc
Subharmonics				
f ≤ 20 GHz	–	–	–	–
f > 20 GHz	–	–	<-40 dBc	<-30 dBc
Nonharmonics at >10 kHz from carrier				
2 to 20 GHz	<-60 dBc	<-60 dBc	<-60 dBc	<-60 dBc

### SSB phase noise, 1 Hz bandwidth, FM off

	Offset from carrier			
Frequency range	100 Hz	1 kHz	10 kHz	100 kHz
2 GHz to 10 GHz	<-64 dBc	<-93 dBc	<-105 dBc	<-105 dBc

### Level

Maximum level R&S®SMP02/22 (without options R&S®SMP-B12/-B13)				
Frequency range	R&S®SMP02		R&S®SMP22	
	Standard	With option R&S®SMP-B15	Standard	With option R&S®SMP-B15
10 MHz to <2 GHz	>+17 dBm			
2 GHz to 20 GHz	>+11.5 dBm	>+10 dBm	>+20 dBm	>+18.5 dBm
Maximum level R&S®SMP02/22 (with options R&S®SMP-B12/-B13)				
Frequency range	R&S®SMP02		R&S®SMP22	
	Pulse mod. off	Pulse mod. on	Pulse mod. off	Pulse mod. on
10 MHz to <2 GHz	>+13 dBm			
2 GHz to 20 GHz	>+11.5 dBm	>+13 dBm	>+20 dBm	>+13 dBm
Maximum level R&S®SMP03/04 (without options R&S®SMP-B12/-B13)				
Frequency range	R&S®SMP03		R&S®SMP04	
	Standard	With option R&S®SMP-B15	Standard	With option R&S®SMP-B17
10 MHz to <2 GHz	>+12 dBm			
2 GHz to <18 GHz	>+10 dBm	>+8.5 dBm	>+10 dBm	>+8.5 dBm
18 GHz to 20 GHz	>+6 dBm	>+4.5 dBm	>+6 dBm	>+4.5 dBm
>20 to 27/33 GHz	>+13 dBm	>+11 dBm	>+12 dBm	>+10 dBm
>33 GHz to 40 GHz	–	–	>+10 dBm	>+8 dBm
Maximum level R&S®SMP03/SMP04 (with options R&S®SMP-B12/-B13)				
Frequency range	R&S®SMP03		R&S®SMP04	
	Pulse mod. off	Pulse mod. on	Pulse mod. off	Pulse mod. on
10 MHz to <2 GHz	>+10 dBm			
2 to 20/27/40 GHz	same as max. level without options R&S®SMP-B12/-B13			
Minimum level of all models				
Without option R&S®SMP-B15/-B17		–20 dBm		
With option R&S®SMP-B15/-B17		–130 dBm		



Contents Overview

Chapter Overview

Type Index

R&amp;S Addresses



## Microwave Signal Generator R&amp;S®SMP

**Total accuracy (frequency response and temperature effect included)**

Frequency range	Level	Accuracy
2 GHz to 20 GHz	>+10 dBm	<±1.3 dB
	>-10 dBm	<±0.7 dB
	>-60 dBm	<±1.0 dB
	≤-60 dBm	<±1.5 dB

Setting time (after IEC/IEEE-bus delimiter)	<10 ms
With option R&S®SMP-B15/-B17, with switching in attenuator set	<25 ms

**Simultaneous modulation** any combination of AM (scan modulation), FM ( $\phi$ M) and pulse modulation

**Linear amplitude modulation**

Operating modes	internal, external AC/DC
Modulation depth	0% to 90%
Modulation frequency range for frequency response <1 dB, m = 60%	DC to 100 kHz
f <2 GHz	DC to 10 kHz
f ≥2 GHz	DC to 50 kHz

**Logarithmic amplitude modulation (scan modulation)**

Operating modes	internal, external
Dynamic range	>30 dB
Sensitivity	0.1 dB/V to 10 dB/V
Resolution	0.01 dB/V
Rise/fall time (10%/90%)	<10 μs

**Frequency modulation**

Operating modes	internal, external AC/DC, locked/ unlocked, two-tone with two separate channels FM1 and FM2
-----------------	---

**Standard FM (without option R&S®SM-B5)**

Maximum deviation f ≤20 GHz	10 MHz
f >20 GHz	20 MHz
Setting accuracy at AF = 100 kHz and 500 kHz deviation	<10% of reading
Modulation frequency range Locked mode	10 kHz to 5 MHz
Unlocked mode	DC to 5 MHz

**FM (with option R&S®SM-B5)**

Maximum deviation f ≤20 GHz	1 MHz
f >20 GHz	2 MHz
Setting accuracy at AF = 1 kHz and deviation >1 kHz	<2% of reading
Modulation frequency range	DC to 1 MHz

**Phase modulation with option R&S®SM-B5**

Operating modes internal, external AC/DC, two-tone with two separate channels  $\phi$ M1 and  $\phi$ M2

Maximum deviation f ≤20 GHz	10 rad
f >20 GHz	20 rad
Setting accuracy at AF = 1 kHz f ≤20 GHz	<(3% of reading + 0.01 rad)
f >20 GHz	<(3% of reading + 0.02 rad)
Modulation frequency range	DC to 100 kHz

**ASK modulation**

Operating mode	external
Maximum modulation depth	90%
Data rate	0 Hz to 200 kHz
Rise/fall time (10%/90%)	<10 μs

**FSK modulation**

Operating mode	external
Maximum shift	10 MHz
Standard FM, f ≤20 GHz	20 MHz
Standard FM, f >20 GHz	1 MHz
With option R&S®SM-B5, f ≤20 GHz	1 MHz
With option R&S®SM-B5, f >20 GHz	2 MHz
Data rate	20 kHz to 2 MHz
Standard FM, locked mode	0 Hz to 2 MHz
Standard FM, unlocked mode	0 Hz to 2 MHz
With option R&S®SM-B5	0 Hz to 2 MHz

**Pulse modulation**

Operating modes	external, internal with option R&S®SMP-B14
Standard (without options R&S®SMP-B12/-B13)	
Frequency range	≥2 GHz
On/off ratio	>50 dB (level >0 dBm)
Rise/fall time (10%/90%)	<500 ns
With options R&S®SMP-B12/-B13	
Frequency range	10 MHz to <2 GHz
With option R&S®SMP-B13	≥2 GHz
With option R&S®SMP-B12	≥2 GHz
On/off ratio	>80 dB
Rise/fall time (10%/90%)	<10 ns

**Internal modulation generator**

Frequency	0.4/1/3/15 kHz ± 3%
-----------	---------------------

**LF generator option R&S®SM-B2**

Waveforms	sinewave, triangular, squarewave, noise
Frequency range	0.1 Hz to 500 kHz
Sinewave, noise	0.1 Hz to 500 kHz
Triangular, squarewave	0.1 Hz to 50 kHz
Frequency response (sinewave)	
Up to 100 kHz	<0.3 dB
Up to 500 kHz	<0.5 dB
Distortion (20 Hz to 100 kHz)	<0.1% (for level >0.5 V)

**Pulse generator option R&S®SMP-B14**

Operating modes	single pulse, delayed pulse, double pulse
Pulse repetition period	100 ns to 85 s
Pulse width	40 ns to 1 s
Pulse delay	40 ns to 1 s
Double pulse	60 ns to 1 s
Trigger delay	<50 ns

**RF control output**

Frequency range	2 GHz to 20 GHz
Level	approx. 0 dBm



Contents Overview

Chapter Overview

Type Index

R&amp;S Addresses





Contents Overview

Chapter Overview

Type Index

R&amp;S Addresses



## Microwave Signal Generator R&amp;S®SMP

## Sweep

	digital sweep in discrete steps
RF sweep, AF sweep Operating modes	AF sweep with option R&S®SM-B2 automatic, single-shot, manual or externally triggered, linear or logarithmic
Sweep range	
Linear step width	user-selectable
Logarithmic step width	0.01% to 50%
Level sweep Operating modes	automatic, single-shot, manual or externally triggered, logarithmic
Sweep range	0.1 dB to 20 dB
Step width	0.1 dB to 20 dB
Step time	10 ms to 1 s
Markers	3, user-selectable

## LIST mode

Frequency and level values can be stored and read out fast; permissible level variation range: 20 dB	
Operating modes	automatic, single-shot, manual or externally triggered
Max. length of list	2003 pairs of frequency and level values

## Memory for instrument settings

Storable settings	50
Memory sequence modes Operating modes	automatic, single-shot, manual or externally triggered
Step time	50 ms to 60 s

## Auxiliary interface with option R&amp;S®SMP-B18

V/GHz output	output voltage proportional to frequency, 0.5 V/GHz or 1 V/GHz selectable
Z output	user-selectable level range -10 V to +10 V

## General data

Remote control	IEC 625 (IEEE 488)
Power supply	90 V to 132 V (AC), 47 Hz to 440 Hz 180 V to 265 V (AC), 47 Hz to 440 Hz autoranging, max. 400 VA
Operating temperature range	0°C to 55°C
Dimensions (W × H × D)	435 mm × 192 mm × 570 mm
Weight	27 kg, when fully equipped

## Ordering information

Order designation	Type	Order No.
Microwave Signal Generator	R&S®SMP02	1035.5005.02
Microwave Signal Generator	R&S®SMP22	1035.5005.22
Microwave Signal Generator	R&S®SMP03	1035.5005.03
Microwave Signal Generator	R&S®SMP04	1035.5005.04
<b>Accessories supplied</b>		
For R&S®SMP02/22/03	power cable, operating manual	
For R&S®SMP04	female adapter 3.5 mm	
	female adapter 2.9 mm	
<b>Options</b>		
OCXO Reference Oscillator	R&S®SMP-B1	1036.5109.02
Frequency Extension 0.01 GHz to 2 GHz <sup>1)</sup>	R&S®SMP-B11	1036.6240.02
Pulse Modulator 2 GHz to 20 GHz (R&S®SMP02, R&S®SMP22) <sup>1)</sup>	R&S®SMP-B12	1036.5750.02
2 GHz to 27 GHz (R&S®SMP03) <sup>1)</sup>	R&S®SMP-B12	1036.5750.03
2 GHz to 40 GHz (R&S®SMP04) <sup>1)</sup>	R&S®SMP-B12	1036.5750.04
0.01 GHz to 2 GHz <sup>1)</sup>	R&S®SMP-B13	1036.7147.02
Pulse Generator	R&S®SMP-B14	1036.7347.02
RF Attenuator 27 GHz (R&S®SMP02, R&S®SMP22, R&S®SMP03) <sup>1)</sup>	R&S®SMP-B15	1036.5250.02
40 GHz (R&S®SMP04) <sup>1)</sup>	R&S®SMP-B17	1036.5550.02
Auxiliary Interface	R&S®SMP-B18	1036.8920.02
Rear Connectors for RF, AF R&S®SMP02, R&S®SMP22, R&S®SMP03 <sup>1)</sup> R&S®SMP04 <sup>1)</sup>	R&S®SMP-B19 R&S®SMP-B20	1039.4303.02 1039.4503.02
LF Generator	R&S®SM-B2	1036.7947.02
FM/φM Modulator	R&S®SM-B5	1036.8489.02
19" Rack Adapter	R&S®ZZA-94	0396.4905.00
<b>Extras</b>		
Service Kit	R&S®SM-Z3	1085.2500.02
Trolley	R&S®ZZK-1	1014.0510.00
Transit Case	R&S®ZZK-945	1013.9372.00
Adapter (R&S®SMP02, R&S®SMP22, R&S®SMP03)		
3.5 mm, female		1021.0512.00
3.5 mm, male		1021.0529.00
N, female		1021.0535.00
N, male		1021.0541.00
Adapter (R&S®SMP04)		
2.9 mm, female		1036.4790.00
2.9 mm, male		1036.4802.00
N, female		1036.4777.00
N, male		1036.4783.00



Contents Overview

Chapter Overview

Type Index

R&amp;S Addresses





Contents Overview

Chapter Overview

Type Index

R&amp;S Addresses



## Microwave Signal Generator R&S®SMR

### R&S®SMR 20/27/30/40:

10 MHz to 20/27/30/40 GHz

High-performance, cost-effective  
and reliable up to 40 GHz



Microwave Signal Generator R&S®SMR40

### Brief description

The R&S®SMR family comprises four basic models designed as CW generators with pulse modulation capability. Offering an excellent price/performance ratio, each of the four basic models is ideal for the user wishing to enter the field of microwave testing at an affordable price. Should measurements become more demanding – no problem with R&S®SMR: all basic models can be upgraded fast and easily by means of options to give a signal generator with AM/FM modulation capability or a synthesized sweep generator featuring fast, fully synthesized analog ramp sweep.

### Main features

#### Wide frequency range

- ◆ R&S®SMR20: 1 GHz to 20 GHz
- ◆ R&S®SMR27: 1 GHz to 27 GHz
- ◆ R&S®SMR30: 1 GHz to 30 GHz
- ◆ R&S®SMR40: 1 GHz to 40 GHz
- ◆ Optional extension of lower frequency limit to 10 MHz (R&S®SMR-B11)
- ◆ Frequency resolution 1 kHz, optional 0.1 Hz (R&S®SMR-B3)

#### High, levelled output power

- ◆ R&S®SMR20 >+10 dBm (at 20 GHz)
- ◆ R&S®SMR27 >+11 dBm (at 27 GHz)
- ◆ R&S®SMR30/40 >+9 dBm (at 30/40 GHz)

#### High precision output level

- ◆ High precision, frequency-response-compensated level control
- ◆ The setting range can be extended to –130 dBm with the optional RF attenuator (option R&S®SMR-B15/B17)

#### Sweep capabilities

- ◆ Digital RF and level sweep (standard version)
- ◆ Analog ramp sweep (RF sweep, option R&S®SMR-B4)
- ◆ Max. sweep rate for ramp sweeps min. 600 MHz/ms (frequency >2 GHz)
- ◆ Digital sweep of LF generator (with option R&S®SMR-B5)
- ◆ 10 freely selectable frequency markers for RF sweep
- ◆ Operating modes: automatic, single-shot, manual, externally triggered

#### Maximum ease of operation

- ◆ High-contrast LC display
- ◆ Online help including IEC/IEEE bus commands
- ◆ All settings simple and self-explanatory
- ◆ User-assignable keys
- ◆ One-hand operation with EasyWheel

#### Memory

- ◆ Space for 50 complete instrument setups
- ◆ Convenient memory sequence modes

#### Optional pulse generator

##### R&S®SMR-B14

- ◆ Operating modes: single pulse, double pulse, externally triggered, gate mode
- ◆ Pulse repetition 100 ns to 85 s
- ◆ Pulse width 20 ns to 1 s

##### Optional IF input (R&S®SMR-B23/ R&S®SMR-B24/R&S®SMR-B25)

- ◆ Built-in upconverter for digitally modulated IF signals from DC to 700 MHz or from 40 MHz to 6 GHz (R&S®SMR-B25)
- ◆ Ideal for use with Vector Signal Generator R&S®SMIQ and I/Q Modulation Generator R&S®AMIQ

### Advantages at a glance

- ◆ CW generator with pulse modulation and digital frequency sweep, easily upgradeable to AM-FM signal generator and synthesized sweeper with analog ramp sweep thanks to flexible options concept
- ◆ Excellent spectral purity, high-precision output level and stable output frequency
- ◆ Simultaneous modulation modes for generation of complex modulation signals for modern communication and location systems
- ◆ Compact, lightweight, user-friendly: ideal in the lab and for field applications
- ◆ 3-year calibration cycle
- ◆ Excellent price/performance ratio



Contents Overview

Chapter Overview

Type Index

R&amp;S Addresses



## Microwave Signal Generator R&S®SMR

### Specifications in brief

You will find detailed and binding data on the enclosed CD (./DATASHEET/SMR.pdf), or, for the latest updates, visit [www.rohde-schwarz.com](http://www.rohde-schwarz.com), search term: **SMR**

Frequency		
Range	w/o option SMR-B11	with option SMR-B11
R&S®SMR20	1 GHz to 20 GHz	10 MHz to 20 GHz
R&S®SMR27	1 GHz to 27 GHz	10 MHz to 27 GHz
R&S®SMR30	1 GHz to 30 GHz	10 MHz to 30 GHz
R&S®SMR40	1GHz to 40 GHz	10 MHz to 40 GHz
Resolution	without option R&S®SMR-B3 1 kHz	with option R&S®SMR-B3 0.1 Hz
Setting time (to within $<1 \cdot 10^{-6}$ )	$<10$ ms + 1 ms/GHz	

Spectral purity	
Spurious signals	
Harmonics	
f ≤ 20 GHz	< -55 dBc
f > 20 GHz	< -40 dBc
Subharmonics	
f ≤ 20 GHz	< -65 dBc
f > 20 GHz	< -30 dBc
Nonharmonics (>50 kHz from carrier)	
f < 20 GHz	< -60 dBc
f > 20 GHz	< -54 dBc
SSB phase noise (f = 10 GHz, 10 kHz from carrier, 1 Hz bandwidth, CW, FM OFF)	< -83 dBc

Level				
Maximum level without option R&S®SMR-B23/-B24/-B25				
Frequency range	R&S®SMR20		R&S®SMR27/SMR30/SMR40	
	w/o R&S®SMR-B15	with R&S®SMR-B15	w/o R&S®SMR-B15/-B17	with R&S®SMR-B15/-B17
0.01 to <1 GHz	>+13 dBm		>+13 dBm	
1 GHz to <18 GHz	>+11 dBm	>+10 dBm	>+8 dBm	>+7 dBm
18 GHz to 20 GHz	>+10 dBm	>+8 dBm	>+7 dBm	>+5 dBm
>20 GHz to 27 GHz	--	--	>+11 dBm	>+9 dBm
>27 GHz to 30 GHz	--	--	>+9 dBm	>+7 dBm
>30 GHz to 40 GHz	--	--	>+9 dBm	>+7 dBm

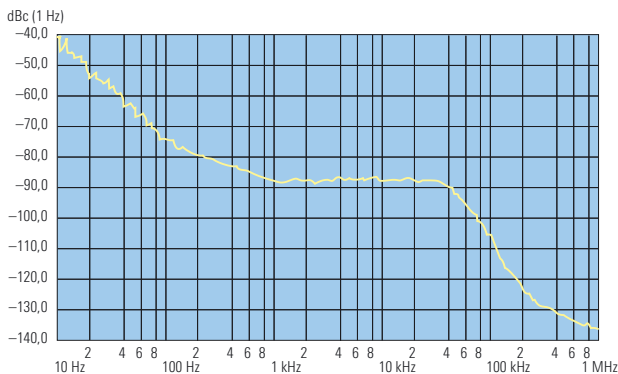

SSB phase noise at 10 GHz

Frequency range	R&S®SMR20		R&S®SMR27/SMR30/SMR40	
	w/o R&S®SMR-B15	with R&S®SMR-B15	w/o R&S®SMR-B15/-B17	with R&S®SMR-B15/-B17
0.01 GHz to <1 GHz	>+13 dBm		>+12 dBm	
1 GHz to <18 GHz	>+10 dBm	>+9 dBm	>+7 dBm	>+6 dBm
18 GHz to 20 GHz	>+8 dBm	>+6 dBm	>+5 dBm	>+3 dBm
>20 GHz to 27 GHz	--	--	>+8 dBm	>+6 dBm
>20 GHz to 30 GHz	--	--	>+6 dBm	>+4 dBm
>30 GHz to 40 GHz	--	--	>+6 dBm	>+4 dBm

Linear amplitude modulation (option R&S®SMR-B5)	
Operating modes	internal, external AC/DC
Modulation depth	0% to 100%
Modulation frequency range	DC to 100 kHz
Logarithmic amplitude modulation (option R&S®SMR-B5 (SCAN AM))	
Operating modes	internal, external
Dynamic range	-30 dB, overrange >30 dB
Sensitivity	-0.1 dB/V to -10 dB/V
Frequency modulation (option R&S®SMR-B5)	
Operating modes	internal, external AC/DC
Maximum deviation	
≤ 15.625 MHz	39.0625 kHz
> 15.625 MHz to 31.25 MHz	78.125 kHz
> 31.25 MHz to 62.5 MHz	156.25 kHz
> 62.5 MHz to 125 MHz	312.5 kHz
> 125 MHz to 250 MHz	625 kHz
> 250 MHz to 500 MHz	1.25 MHz
> 500 MHz to < 1 GHz	2.5 MHz
1 GHz to 2 GHz	5 MHz
> 2 GHz to 10 GHz	10 MHz
> 10 GHz to 20 GHz	20 MHz
f > 20 GHz	40 MHz
Modulation frequency range	DC to 5 MHz
ASK modulation (option R&S®SMR-B5)	
Operating modes	internal, external
Maximum modulation depth	90%
Data rate	0 Hz to 200 kHz

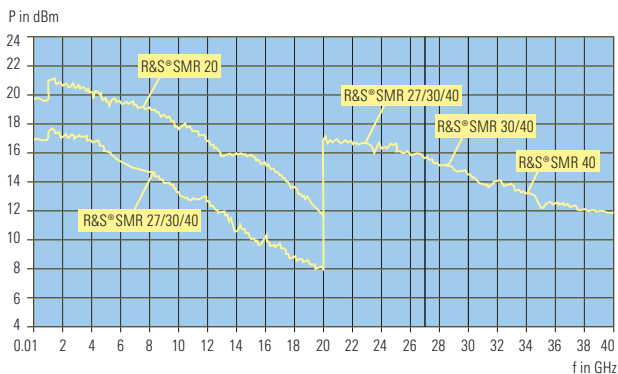

Typical maximum output level over frequency (with option SMR-B15/-B17)



## Microwave Signal Generator R&S®SMR

<b>FSK modulation (option R&amp;S®SMR-B5)</b>	
Operating modes	internal, external
Maximum deviation	
≤15.625 MHz	39.0625 kHz
>15.625 MHz to 31.25 MHz	78.125 kHz
ranges increased by a factor of 2	increased by a factor of 2
>10 GHz to 20 GHz	20 MHz
f >20 GHz	40 MHz
Data rate	0 Hz to 2 MHz
<b>Pulse modulation</b>	
Operating modes	external, internal with option SMR-B14
On/off ratio	>80 dB
Raise-/fall time (10%/90%), >450 MHz	<12 ns
Minimum pulse width, ALC OFF	20 ns
Max/min pulse/pause, ALC ON	free
Maximum pulse repeat frequency >450 MHz	10 MHz

<b>IF input (option R&amp;S®SMR-B23/-B24/-B25)</b>			
	R&S®SMR-B23	R&S®SMR-B24	R&S®SMR-B25
IF input	DC to 700 MHz	DC to 700 MHz	40 MHz to 6 GHz
RF output	1 GHz to 20 GHz	2 GHz to 27/30/40 GHz	1 GHz to 20 GHz
Conversion loss (IF input/RF output)			
with option R&S®SMR-B15/-B17 <sup>1)</sup>	6 dB to 15 dB	6 dB to 20 dB	6 dB to 15 dB
w/o option R&S®SMR-B15/-B17	6 dB to 13 dB	6 dB to 16 dB	6 dB to 13 dB

<sup>1)</sup> Option R&S®SMR-B15/-B17 in zero position. The conversion loss can be increased with option R&S®SMR-B15/-B17 by 10 dB to 110 dB in 10-dB steps. With option R&S®SMR-B19/-B20 conversion loss increases up to 0.1 dB/GHz.

<b>LF generator (option R&amp;S®SMR-B5)</b>	
Frequency range	0.1 Hz to 10 MHz
Waveforms	sinewave, squarewave
<b>Pulse generator (option R&amp;S®SMR-B14)</b>	
Operating modes	single or double pulse (automatic or externally triggered), delayed pulse (externally triggered), gate mode (external)
Pulse periode	100 ns to 85 s
Pulse width	20 ns to 1 s
Pulse delay	20 ns to 1 s
Double pulse distance	60 ns to 1 s
<b>Digital sweep, sweep in discrete steps</b>	
RF sweep, AF sweep	
Operating modes	automatic, single-shot, manual or externally triggered, linear or logarithmic
Sweep range	freely selectable
Step width (lin)	freely selectable
Step width (log)	0.01% to 100%
Level sweep	
Operating modes	automatic, single-shot, manual or externally triggered, logarithmic
Sweep range	0 dB to 20 dB
Step time	1 ms to 1 s
Markers	10, free selectable
<b>Ramp sweep (option R&amp;S®SMR-B4)</b>	
RF sweep, AF sweep	
Operating modes	automatic, single-shot, manual or externally triggered, start/stop, center frequency, center span, marker
Sweep range	free selectable
Sweep time	10 ms to 100 s (≤30 ms switchover time at 1/2/10 and 20 GHz)

Maximum sweep speed	
≤15.625 MHz	2.34375 MHz/ms
>15.625 MHz to 31.25 MHz	4.6875 MHz/ms
ranges increased by a factor of 2	increased by a factor of 2
>10 GHz to 20 GHz	1200 MHz/ms
f >20 GHz	2400 MHz/ms
<b>List mode</b>	Frequency and level values can be stored in a list and will be set very fast
Permissible level variation	20 dB
Operating modes	automatic, single-shot, manual or externally triggered
Step time	1 ms to 1 s

### General data

Remote control	IEC625 (IEEE 488)
Power supply	100 V to 120 V (AC), 50 Hz to 400 Hz, 200 V to 240 V (AC), 50 Hz to 60 Hz, autotsetting to AC voltage, max. 200 VA
Dimensions (W × H × D)	426.7 mm × 87.6 mm × 450 mm
Weight	<12 kg when fully equipped

### Ordering information

<b>Signal generator</b>	R&S®SMR 20	1104.0002.20
	R&S®SMR 27	1104.0002.27
	R&S®SMR 30	1104.0002.30
	R&S®SMR 40	1104.0002.40
<b>Accessories supplied</b>	Power cable, operating manual, adapter 3.5 mm female (R&S®SMR 20), adapter 2.9 mm female (R&S®SMR 27/30/40)	
<b>Options</b>		
Reference Oscillator OCXO	R&S®SMR-B1	1104.5485.02
Frequency Resolution 0.1 Hz	R&S®SMR-B3	1104.5585.02
Ramp Sweep	R&S®SMR-B4	1104.5685.02
AM/FM/Scan Modulator	R&S®SMR-B5	1104.3501.02
Frequency Extension 0.01 GHz to 1 GHz <sup>1)</sup>	R&S®SMR-B11	1104.4250.02
Pulse Generator	R&S®SMR-B14	1104.3982.02
RF Attenuator for R&S®SMR 20/R&S®SMR 27 <sup>1)</sup>	R&S®SMR-B15	1104.4989.02
RF Attenuator for R&S®SMR 30/R&S®SMR 40 <sup>1)</sup>	R&S®SMR-B17	1104.5233.02
Rear Connectors for RF, AF (R&S®SMR 20/R&S®SMR 27) <sup>1)</sup>	R&S®SMR-B19	1104.6281.02
Rear Connectors for RF, AF (R&S®SMR 30/R&S®SMR 40) <sup>1)</sup>	R&S®SMR-B20	1104.6381.02
IF Input 20 GHz for R&S®SMR 20 <sup>1)</sup>	R&S®SMR-B23	1104.5804.02
IF Input 40 GHz for R&S®SMR 27/R&S®SMR 30/R&S®SMR 40 <sup>1)</sup>	R&S®SMR-B24	1104.6100.02
IF Input 0.04 GHz to 6 GHz for R&S®SMR 20 <sup>1)</sup>	R&S®SMR-B25	1135.1998.02
Low MW Leakage (not with -B23/24/25) <sup>1)</sup>	R&S®SMR-B31	1164.7910.02
<b>Extras</b>		
Service Kit	R&S®SMR-Z1	1103.9506.02
Aux-port to BNC Interface	R&S®SMR-Z3	1134.9772.02
19" Rack Adapter	R&S®ZZA-211	1096.3260.00
<b>Adapter (R&amp;S®SMR 20)</b>		
3.5 mm female		1021.0512.00
3.5 mm male		1021.0529.00
N female		1021.0535.00
N male		1021.0541.00
<b>Adapter (R&amp;S®SMR 27/30/40)</b>		
2.9 mm female		1036.4790.00
2.9 mm male		1036.4802.00
N female		1036.4777.00
N male		1036.4783.00

<sup>1)</sup> Option factory-fitted only.

## Microwave Signal Generators R&amp;S®SMR50/60

R&amp;S®SMR50: 10 MHz to 50 GHz

R&amp;S®SMR60: 10 MHz to 60 GHz

High-performance, cost-effective  
and reliable up to 60 GHz

*Microwave Signal Generator R&S®SMR60*



## Brief description

The R&S®SMR50/60 are designed as CW generators with pulse modulation capability. Offering an excellent price/performance ratio, each of the models is ideal for economical measuring setups in the field of microwave testing up to 60 GHz at an affordable price. Should the measurement tasks become more demanding, both models can be upgraded any time by means of options to give an AM/FM signal generator or a synthesized sweep generator featuring fast, fully synthesized, analog ramp sweep.

## Excellent spectral purity

The R&S®SMR50/60 stands out from other generators for its excellent spectral purity. Advanced frequency synthesis makes for low SSB phase noise and high spurious suppression, both of which are for example prerequisites for reliable receiver measurements. Modern microwave filters in the output path of the instrument ensure excellent harmonics suppression. This is necessary to obtain conclusive results in scalar network analysis measurements.

## High-precision output level

Microwave signal generators are frequently used for calibrating test receivers. This task calls for a highly accurate

and stable output level settable with high resolution. This is ensured by a high-precision, frequency-response-compensated level control for levels higher than  $-20$  dBm. This range can be extended to  $-110$  dB with the optional RF Attenuator R&S®SMR-B18.

## Main features

## Ease of operation

- ◆ High-contrast LC display
- ◆ Online help including IEC/IEEE-bus commands
- ◆ Simple and self-explanatory settings
- ◆ Storage of menu layers
- ◆ One-hand operation with EasyWheel

## Wide frequency range

- ◆ 1 GHz to 50 GHz (R&S®SMR50)
- ◆ 1 GHz to 60 GHz (R&S®SMR60)
- ◆ Extension of lower frequency limit to 10 MHz (option R&S®SMR-B11)
- ◆ Frequency resolution 1 kHz, 0.1 Hz (option R&S®SMR-B3)

## High output power

- ◆ without option R&S®SMR-B18
  - R&S®SMR50  $>+3$  dBm (at 50 GHz)
  - R&S®SMR60  $>0$  dBm (at 60 GHz)
- ◆ with option R&S®SMR-B18
  - R&S®SMR50  $>0$  dBm (at 50 GHz)
  - R&S®SMR60  $>-4$  dBm (at 60 GHz)

## High-precision level control

- ◆ High-precision, frequency-response-compensated level control
- ◆ Setting range extendible to  $-110$  dBm (option R&S®SMR-B18)

## Three instruments in one

- ◆ CW generator with pulse modulation capability (standard version)
- ◆ Signal generator with AM/FM SCAN and LF generator (option R&S®SMR-B5)
- ◆ Synthesized sweep generator with analog ramp sweep (option R&S®SMR-B4)

## Optional pulse generator (R&amp;S®SMR-B14)

- ◆ Operating modes: single pulse, double pulse (automatically or externally triggered), delayed pulse (externally triggered), gate mode (external)
- ◆ Pulse repetition 100 ns to 85 s
- ◆ Pulse width 20 ns to 1 s

## Sweep capabilities

- ◆ Digital RF and level sweep (standard version)
- ◆ Analog ramp sweep (RF sweep, option R&S®SMR-B4)
- ◆ Maximum sweep rate for ramp sweeps min. 600 MHz/ms ( $f > 2$  GHz)
- ◆ Digital sweep of LF generator (with option R&S®SMR-B5)

## Microwave Signal Generators R&S®SMR50/60

- ◆ 10 freely selectable frequency markers for RF sweep
- ◆ Operating modes: automatic, single-shot, manual, externally triggered, linear or logarithmic

### Further features

- ◆ Space for 50 complete instrument setups
- ◆ Compact, lightweight, user-friendly: ideal in the lab and for field applications
- ◆ 3-year calibration cycle

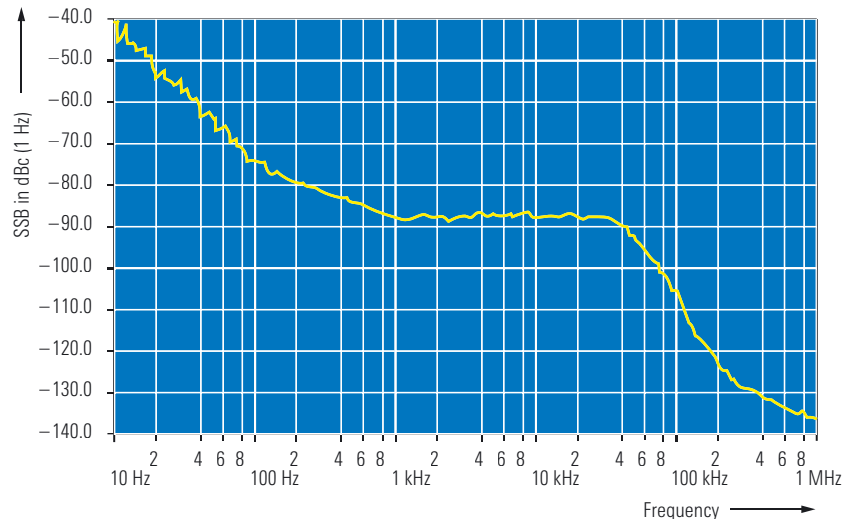

SSB phase noise at 10 GHz

### Specifications in brief

You will find detailed and binding data on the enclosed CD (./DATASHEET/SMR50.pdf), or, for the latest updates, visit [www.rohde-schwarz.com](http://www.rohde-schwarz.com), search term: SMR

Frequency	
R&S®SMR50	
Without option R&S®SMR-B11	1 GHz to 50 GHz
With option R&S®SMR-B11	10 MHz to 50 GHz
R&S®SMR60	
Without option R&S®SMR-B11	1 GHz to 60 GHz
With option R&S®SMR-B11	10 MHz to 60 GHz
Resolution w.o./with option R&S®SMR-B3	1 kHz/0.1 Hz
Spectral purity	
Harmonics <sup>1)</sup>	
10 MHz ≤ f ≤ 30 MHz	<-50 dBc
30 MHz < f ≤ 20 GHz	<-55 dBc
f > 20 GHz <sup>2)</sup>	<-40 dBc
Subharmonics, f ≤ 20 GHz	<-65 dBc
Subharmonics, f > 20 GHz	<-30 dBc
Subharmonics (carrier offset > 50 kHz)	
f ≤ 20 GHz	<-60 dBc
20 GHz < f ≤ 40 GHz	<-54 dBc
f > 40 GHz	<-52 dBc
SSB phase noise (f = 10 GHz, 10 kHz from carrier, 1 Hz bandwidth, CW, FM off)	<-83 dBc
Level	
Maximum level <sup>3)</sup>	
Frequency range	w.o./with option R&S®SMR-B18
0.01 GHz ≤ f < 1 GHz	>+11 dBm
1 GHz ≤ f < 18 GHz	>+8 dBm/>+7 dBm
18 GHz ≤ f ≤ 20 GHz	>+7 dBm/>+5 dBm
20 GHz < f ≤ 27 GHz	>+11 dBm/>+9 dBm
27 GHz < f ≤ 30 GHz	>+9 dBm/>+7 dBm
30 GHz < f ≤ 40 GHz	>+7 dBm/>+5 dBm
40 GHz < f ≤ 50 GHz	>+3 dBm/>+0 dBm
50 GHz < f ≤ 60 GHz	>0 dBm/>-4 dBm

Minimum level of all models	
Without option R&S®SMR-B18	-20 dBm
With option R&S®SMR-B18	-110 dBm
Total deviation (level = -4 dBm)	
f ≤ 20 GHz	<1 dB
20 GHz < f ≤ 40 GHz	<1.4 dB
f > 40 GHz	<1.8 dB
Frequency response (level = -4 dBm)	
f ≤ 20 GHz <sup>4)</sup>	<0.5 dB, typ. <±0.3 dB
20 GHz < f ≤ 40 GHz	<0.7 dB, typ. <±0.4 dB
f > 40 GHz	<0.9 dB, typ. <±0.5 dB
Setting time after IEC/IEEE-bus delimiter	<10 ms
With option R&S®SMR-B18, with switching in attenuator	<25 ms
Range for non-interrupting level setting	>16 dB
Linear amplitude modulation (option R&S®SMR-B5)	
Operating modes	intern, extern AC/DC
Modulation depth <sup>5)</sup>	0% to 100%
Logarithmic amplitude modulation (option R&S®SMR-B5 (SCAN AM))	
Operating modes	internal, external
Dynamic range	>20 dB
Sensitivity	±0.1 dB/V to ±10 dB/V
Rise/fall time (10%/90%)	<10 μs
Frequency modulation (option R&S®SMR-B5)	
Operating modes	internal, external AC/DC
Maximum deviation	
f ≤ 15.625 MHz	39.0625 kHz
15.625 MHz < f ≤ 31.25 MHz	78.125 kHz
ranges increased by a factor of 2	increased by a factor of 2
20 GHz < f ≤ 40 GHz	40 MHz
f > 40 GHz	80 MHz
Modulation frequency range	DC to 5 MHz
ASK modulation	
Modulation frequency range	external, option R&S®SMR-B5
Maximum modulation depth	90%
Data rate, f < 1 GHz	0 Hz to 100 kHz
Data rate, f ≥ 1 GHz	0 Hz to 200 kHz
Rise/fall time (10%/90%), f < 1 GHz	<10 μs
Rise/fall time (10%/90%), f ≥ 1 GHz	<5 μs



Contents Overview

Chapter Overview

Type Index

R&amp;S Addresses



## Microwave Signal Generators R&amp;S®SMR50/60

<b>FSK modulation</b>	external, <b>option R&amp;S®SMR-B5</b>
Maximum deviation	
$f \leq 15.625$ MHz	39.0625 kHz
$15.625$ MHz $< f \leq 31.25$ MHz	78.125 kHz
ranges increased by a factor of 2	increased by a factor of 2
$20$ GHz $< f \leq 40$ GHz	40 MHz
$f > 40$ GHz	80 MHz
Data rate	0 Hz to 2 MHz
Rise/fall time (10%/90%)	<500 ns
<b>Pulse modulation</b>	external, internal <b>option R&amp;S®SMR-B14</b>
On/off ratio	>80 dB
On/off ratio (10%/90%), $f > 450$ MHz	<12 ns <sup>6)</sup>
Minimum pulse width (ALC OFF)	25 ns
Maximum pulse pause (ALC OFF)	any
With level control off (ALC OFF)	any
Maximum pulse repetition frequency	
$f > 450$ MHz	10 MHz
Pulse delay	typ. 50 ns
Video feedthrough $V_{DD}$	<20 mV
<b>Simultaneous modulation</b>	
FM (FSK) is independent of AM (SCAN AM, ASK) and pulse modulation. Reduced AM bandwidth for simultaneous AM (SCAN AM, ASK) and pulse modulation.	
<b>LF generator</b>	<b>option R&amp;S®SMR-B5</b>
Frequency range	0.1 Hz to 10 MHz
Waveforms	sinewave, squarewave
Frequency response (up to 500 kHz)	<0.5 dB
Distortion (up to 100 kHz)	<0.5% ( $R_L > 200 \Omega$ , level = 0.5 V)
<b>Pulse generator</b>	<b>option R&amp;S®SMR-B14</b>
Operating modes	single or double pulse (automatically or externally triggered), delayed pulse (externally triggered), gate mode (external)
Active trigger edge	positive or negative
Pulse repetition period	100 ns to 85 s
Pulse width	20 ns to 1 s
Pulse delay	20 ns to 1 s
Double pulse	60 ns to 1 s
Trigger delay	typ. 50 ns
<b>Digital sweep, sweep in discrete steps</b>	
RF sweep, AF sweep	
Operating modes	automatic, single-shot, manual or externally triggered, logarithmic
Sweep range	freely selectable
Step width (lin)	freely selectable
Step width (log)	0.01% to 100%
Step time	10 ms to 5 s
Level sweep	
Operating modes	automatic, single-shot, manual or externally triggered, logarithmic
Sweep range	0 dB to $\geq 16$ dB
Step width	0.01 dB to 20 dB
Step time	1 ms to 5 s
Markers	10, freely selectable
<b>Ramp sweep</b>	<b>option R&amp;S®SMR-B4</b>
RF sweep	automatic, single-shot, manual or externally triggered
Operating modes	Start/Stop, center frequency/span
Sweep range	freely selectable, increasing
Sweep time <sup>6)</sup>	10 ms to 100 s

Max. sweep rate	
$f \leq 15.625$ MHz	2.34375 MHz/ms
$15.625$ MHz $< f \leq 31.25$ MHz	4.6875 MHz/ms
ranges increased by a factor of 2	increased by a factor of 2
$20$ GHz $< f \leq 40$ GHz	2400 MHz/ms
$f > 40$ GHz	4800 MHz/ms
Markers	10, freely selectable
<b>List mode</b>	
Frequency and level values can be stored in a list.	
Permissible level variation	max. 20 dB
Operating modes	auto, single-shot, manual or external trigger
Maximum number of frequency/level entries	2003
Maximum number of lists	up to 10
Step time	1 ms to 5 s
<b>General data</b>	
Storable instrument setups	50
Remote control	IEC 625-1 (IEEE 488.1)
Rated temperature range	0°C to +55°C
Power supply	100 to 120 V (AC), 50 Hz to 400 Hz, 200 V to 240 V (AC), 50 to 60 Hz, autoranging, max. 300 VA
Dimensions (W × H × D)	426.7 mm × 131.4 mm × 450 mm
Weight	<13.5 kg when fully equipped

- 1) R&S®SMR50: level <0 dBm. SMR60: level <0 dBm for  $f \leq 50$  GHz or <-4 dBm for  $f > 50$  GHz.
- 2) Specifications for harmonics above 50 GHz (R&S®SMR50) and 60 GHz (R&S®SMR60) only typical.
- 3) Maximum level is reduced by up to 2 dB in the temperature range 35°C to 55°C.
- 4) From 10 MHz to 50 MHz, the specified total deviation is only valid in the temperature range 15°C to 35°C. The deviation outside this temperature range is likely to be higher by max. 0.7 dB.
- 5) The modulation depth adjustable within the AM specifications continuously decreases from 6 dB below the maximum level up to the maximum level.
- 6)  $\leq 30$  ms switching time at 1 GHz, 2 GHz, 10 GHz, 20 GHz and 40 GHz.

## Ordering information

<b>Microwave Signal Generator</b>	R&S®SMR50	1134.9008.50
	R&S®SMR60	1134.9008.60
<b>Accessories supplied</b>	Power cable, operating manual	
<b>Options</b>		
OXCXO Reference Oscillator	R&S®SMR-B1	1104.5485.02
Frequency Resolution 0.1 Hz	R&S®SMR-B3	1104.5585.02
Ramp Sweep	R&S®SMR-B4	1104.5685.02
AM/FM/Scan Modulator	R&S®SMR-B5	1104.3501.03
Frequency Extension 0.01 GHz to 1 GHz <sup>1)</sup>	R&S®SMR-B11	1104.4250.60
Pulse Generator	R&S®SMR-B14	1104.3982.02
RF Attenuator <sup>1)</sup>	R&S®SMR-B18	1135.2907.02
Rear Connectors for AF	R&S®SMR-B21	1135.2407.02
<b>Extras</b>		
Service Kit	R&S®SMR-Z1	1103.9506.02
Interface Cable	R&S®SMR-Z3	1134.9772.02
19" Rack Adapter	R&S®ZZA-311	1096.3277.00

- 1) Factory-fitted option.



Contents Overview

Chapter Overview

Type Index

R&amp;S Addresses



## I/Q Modulation Generator R&S® AMIQ

### 16 Msample

### New approaches in the generation of complex I/Q signals



### Brief description

I/Q Modulation Generator R&S® AMIQ04 and Simulation Software R&S® WinIQSIM™ open up new dimensions for the generation of I/Q signals. R&S® AMIQ is a dual-channel modulation generator that has consequently been designed for use as an I/Q source. It is programmed and set with Software R&S® WinIQSIM™. Alternatively, R&S® AMIQ can be operated from a Vector Signal Generator R&S® SMIQ.

Each channel can store 16 000 000 samples respectively. Even at high symbol rates sequences of sufficient length can thus be generated. With clock frequencies of up to 100 Msample/s and a high amplitude resolution of 14 (up to 16 bits via digital I/Q output) bits, R&S® AMIQ is the ideal source for any signal in the world of digital modulation. An automatic amplitude/offset alignment as well as fine adjustment of the skew provide excellent symmetry of the two channels which previously was extremely difficult to attain with dual-channel ARB generators. The error vector can thus be minimized. A typ-

ical application of R&S® AMIQ and R&S® WinIQSIM™ is not only to drive the I/Q inputs of a vector signal generator. This combination is also ideal for direct applications in the baseband, e.g. for testing I/Q modulators/demodulators.

### Main features

#### R&S® AMIQ

- ◆ 14-bit resolution (up to 16 bits via digital I/Q output)
- ◆ 16 000 000 samples memory depth
- ◆ 100 MHz sample rate
- ◆ Integrated hard disk and FDD
- ◆ Optional BER measurement
- ◆ Optional differential I/Q outputs
- ◆ Optional digital I/Q output

#### R&S® WinIQSIM™

- ◆ Calculation of digitally modulated I/Q and IF signals
- ◆ Single-carrier, multicarrier and CDMA, WCDMA 3GPP and W-LAN signals
- ◆ Import of I/Q signals via DDE interface
- ◆ Versatile data editor
- ◆ Superposition/simulation of impairments
- ◆ Graphic display

### I/Q simulation software

Modulation methods like GMSK or  $\pi/4$ DQPSK are used in mobile communication systems such as GSM (Global System for Mobile Communications) or NADC (North American Digital Cellular). These complex modulation modes are usually generated with the aid of an I/Q or vector modulator. The calculation and generation of the required baseband signals is of course quite complex.

R&S® WinIQSIM™ is a Windows software allowing calculation of I and Q baseband signals. Its capabilities range from single-carrier modulation, generation of multicarrier, CDMA and WCDMA signals through to TDMA frame configurations with the help of a convenient data editor. All modulation parameters and impairments can be simulated for single-carrier and multi-carrier as well as for CDMA signals. To put it in a nutshell: R&S® WinIQSIM™ is an indispensable tool for anyone engaged in modern digital modulation.

### Specifications in brief

You will find detailed and binding data on the enclosed CD (./DATASHEET/AMIQ.pdf), or, for the latest updates, visit [www.rohde-schwarz.com](http://www.rohde-schwarz.com), search term: AMIQ

Output memory	
Waveform length (data and markers)	
Clock rate	
Slow mode, 10 Hz to 4 MHz	24 to 16 000 000 in steps of one
Fast mode, 2 MHz to 100 MHz	24 to 16 000 000 in steps of four
Amplitude resolution of data words	selectable word length 8 bit to 14 bit; up to 16 bit at digital output
Marker channels	4, can be used as marker or trigger outputs (for word lengths up to 14 bit)



Contents Overview

Chapter Overview

Type Index

R&amp;S Addresses



## I/Q Modulation Generator R&amp;S® AMIQ

<b>Multisegment waveform</b>	max. 30 segments
Segment changeover time	
without clock change	typ. 4 ms
with clock change	typ. 12 ms
<b>Signal output</b>	I and Q
Output voltage ( $V_p$ into 50 $\Omega$ )	
Fix mode	0.5 V, same for both channels
Variable mode	0 V to 1 V, separately adjustable for each channel
Skew between I and Q channel (filter off, clock rate 10 MHz, fix mode)	
Fine variation	typ. $\pm 1$ ns
<b>Adjacent-channel power</b>	
WCDMA 3GPP FDD	
Test model 1 (64 DPCH channels)	
Offset 5 MHz, 10 MHz	typ. -78 dBc
<b>Error vector</b>	
IS-95 (QPSK)	typ. 0.35% EVM (rms)
GSM (GMSK)	typ. 0.2° phase error (rms)
DECT (2-FSK)	typ. 0.9% FSK error
NADC, PHS ( $\pi/4$ DQPSK)	typ. 0.3% EVM (rms)
<b>Filters</b>	
Operating modes	off (no filter), internal or external filter
Internal filters, 25 MHz	elliptic, 7th order + delay equalizer
Freq. response, amplitude	typ. 0.15 dB up to 25 MHz
Freq. response, group delay	typ. 500 ps up to 20 MHz
Internal filters, 2.5 MHz	elliptic, 7th order + delay equalizer
Freq. response, amplitude	typ. 0.15 dB up to 2.5 MHz
Freq. response, group delay	typ. 5 ns up to 2 MHz
External filters	one filter can be connected for each channel, BNC connectors on rear panel
<b>Trigger</b>	
CONT mode	repetitive output of loaded waveform after occurrence of trigger
SINGLE mode	single output of loaded waveform after occurrence of trigger
GATED mode	start of (repetitive) waveform output after occurrence of trigger until end of trigger event
Trigger signal	via remote control or trigger input
<b>Marker outputs</b>	4, BNC connectors
<b>BER measurement (option R&amp;S® AMIQ-B1)</b>	
Data supplied by the DUT can be compared with a nominal random bit sequence; the results are transferred to the host computer (via the currently used remote control); the BER measurement can be controlled from R&S® WinIQSIM™ and R&S® SMIQ.	
Pseudo random bit sequences	$2^9-1$ , $2^{11}-1$ , $2^{15}-1$ , $2^{16}-1$ , $2^{20}-1$ , $2^{21}-1$ , $2^{23}-1$
Measurement time	selectable through max. number of data or error bits (max. $2^{31}$ bit), continuous measurement
Measurement results	BER in ppm (when set number of data or error bits is attained), not synchronized, no clock from DUT
<b>Differential I/Q outputs (option R&amp;S® AMIQ-B2)</b>	
Provides the inverted $\bar{I}$ and $\bar{Q}$ signals and allows a DC voltage to be simultaneously superimposed on the output signal.	
Outputs	I, $\bar{I}$ , Q and $\bar{Q}$
Operating mode	single/differential, selectable
Bias voltage (EMF, to ground)	-2.5 V to +2.5 V ( $\pm 10$ mV) for both I and Q channels separate, common setting for I and $\bar{I}$ or Q and $\bar{Q}$

Output voltage (differential EMF between the I and $\bar{I}$ or Q and $\bar{Q}$ outputs, unless otherwise specified, $V_D$ )	
Fix mode	2 V, same for both I and Q channels
DC fine variation	typ. $\pm 120$ mV
Variable mode	0 V to 4 V, separately adjustable for I and Q channels
DC fine variation	typ. $\pm 280$ mV
<b>Digital I/Q output (option R&amp;S® AMIQ-B3)</b>	
Channels	I and Q
Resolution	8 bit to 16 bit (selectable, no marker output for word lengths > 14 bit)
Output level	LVT or ABT level (data, marker and clock); the high level of the data, marker and clock signals is automatically adapted to the selected supply voltage for external circuits
$V_{cc}$ output	+3.3 V or +5 V
<b>Remote control and memory</b>	via IEC 60625 (IEEE 488) and RS-232-C
Mass memory	FDD (3.5", 1.44 MB), hard disk
Download time (4000000 I/Q samples from built-in hard disk)	27 s
<b>General data</b>	
Operating temperature range	+5°C to +45°C
Power supply	100 V to 120 V $\pm 10\%$ , 50 Hz to 400 Hz, 200 V to 240 V $\pm 10\%$ , 50 Hz to 60 Hz, autoranging, 150 VA
Dimensions (W x H x D)	427 mm x 88 mm x 450 mm
Weight	8.7 kg

## Ordering information

<b>I/Q Modulation Generator</b>		
16 Msamples	R&S® AMIQ	1110.2003.04
<b>Accessories supplied</b>		
R&S® WinIQSIM™ version for Windows 95/98/NT/2000 on CD-ROM; manual, power cable, R&S® AMIQ operating manual		
<b>Options</b>		
BER Measurement	R&S® AMIQ-B1	1110.3500.02
Differential I/Q Outputs	R&S® AMIQ-B2	1110.3700.03
Digital I/Q Output	R&S® AMIQ-B3	1122.2103.02
Rear I/Q Outputs	R&S® AMIQ-B19 <sup>1)</sup>	1110.3400.02
Digital Standards		
IS-95	R&S® AMIQK11	1122.2003.02
CDMA2000	R&S® AMIQK12	1122.2503.02
WCDMA TDD Mode (3GPP)	R&S® AMIQK13	1122.2603.02
TD-SCDMA	R&S® AMIQK14	1122.2703.02
1xEV-DO	R&S® AMIQK17	1122.3000.02
IEEE802.11	R&S® AMIQK19	1122.3200.02
3GPP FDD incl. HSDPA	R&S® AMIQK20	1122.3200.02
OFDM Signal Generation	R&S® AMIQK15	1122.2803.02
<b>Recommended extra</b>		
19" Rack Adapter	R&S® ZZA-211	1096.3260.00

- 1) Data at clock > 100 MHz are not warranted, max. environment temperature 35 °C.
- 2) Marker outputs 3 and 4 not provided if this option is fitted, R&S® AMIQ-B19 not suitable in conjunction with R&S® AMIQ-B2.
- 3) R&S® WinIQSIM™ required.



Contents Overview

Chapter Overview

Type Index

R&amp;S Addresses





## Simulation Software R&S® WinIQSIM™

### Ideal for the generation of digitally modulated signals

#### Brief description

R&S® WinIQSIM™ was especially developed for the generation of digitally modulated signals. Complex signals can thus easily be generated. The graphical user interface allows intuitive operation, supported by context-sensitive help. The convenient way of creating any TDMA frame configurations with the aid of a data editor, and the generation of multicarrier signals as well as of complex WCDMA signals make R&S® WinIQSIM™ suitable for a wide range of applications. Moreover, additive impairments can be superimposed on a signal.

The signals generated with the aid of the R&S® WinIQSIM™ software can be output by the integrated solution in the R&S® SMU (option R&S® SMU-B10) and the R&S® SMIQ (option R&S® SMIQB60) as well as the I/Q Modulation Generator R&S® AMIQ. R&S® WinIQSIM™ is provided with these three arbitrary waveform generators free of charge.

#### Main features

- ◆ Calculation of digitally modulated I/Q and IF signals
- ◆ For driving the internal arbitrary waveform generator of the R&S® SMU (R&S® SMU-B10), the R&S® SMIQ (R&S® SMIQB60) and the I/Q Modulation Generator R&S® AMIQ
- ◆ Single-carrier, multicarrier, multi-carrier mixed signals and CDMA signals

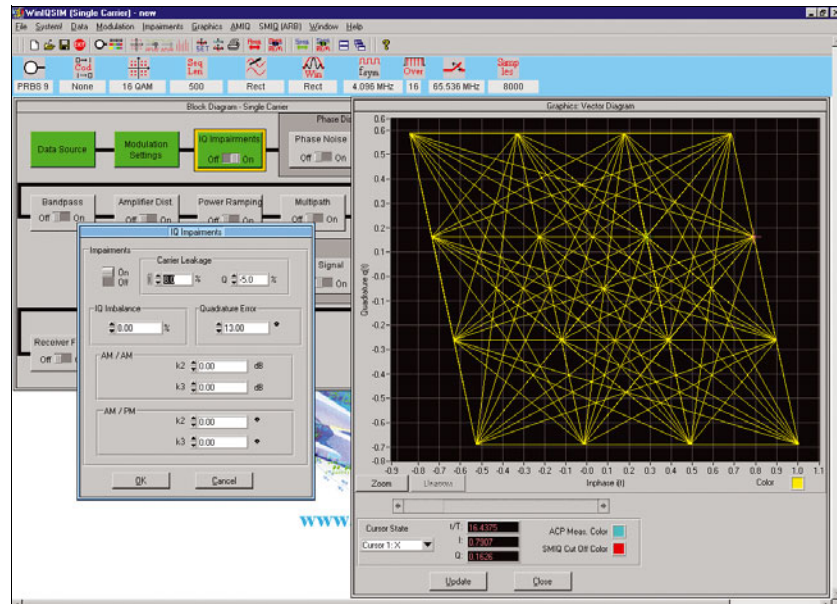

*Simulation of I/Q impairments, here for 16QAM*

- ◆ 3GPP FDD mode including data sets for the test models to 3GPP
- ◆ 3GPP FDD mode including HSDPA (R&S® SMU-K20/R&S® SMIQK20/R&S® AMIQK20)
- ◆ 3GPP TDD mode optional (R&S® SMU-K13/SMIQK13/AMIQK13)
- ◆ TD-SCDMA optional (R&S® SMU-K14/ SMIQK14/AMIQK14)
- ◆ IS-95 CDMA optional (R&S® SMU-K11/ SMIQK11/AMIQK11)
- ◆ cdma2000 optional (R&S® SMU-K12/ SMIQK12/AMIQK12)
- ◆ Versatile data editor
- ◆ Superposition/simulation of impairments
- ◆ Graphical display
- ◆ Can be enhanced by import interface for additional software
- ◆ 1xEV-DO optional (R&S® SMU-K17/SMIQK17/AMIQK17)
- ◆ IEEE802.11 (a,b,g) optional (R&S® SMU-K19/SMIQK19/AMIQK19)

#### Characteristics

##### Install it and go ahead

In developing R&S® WinIQSIM™, great importance was attached to user-friendly operation. The main parameters of a signal, for example, are indicated in a status line. The context-sensitive online help enables handling of even complex functions without consulting the manual.

The program always starts with the settings of the previous session, thus ensuring easy continuation of work.

##### Import system

Data from other PC programs can be read in via the import system. The TCP/IP or the dynamic data exchange (DDE) interface serves as the software interface.

Data can, for example, be imported from the R&S® WinIQOFDM software, which is used for generating OFDM-modulated signals. Through subsequent processing



## Simulation Software R&S® WinIQSIM™

in R&S® WinIQSIM™, signal modifications such as baseband filtering and superimposed impairments can be applied to the signal to be generated.

The import interface also forms the basis for further applications (e.g. R&S® IQWizard, for more information see [www.rohde-schwarz.com](http://www.rohde-schwarz.com)) or customer-specific enhancements.

### Remote-control functions

The R&S® WinIQSIM™ PC program is used to control and operate the internal arbitrary waveform generators of R&S® SMU (R&S® SMU-B10), R&S® SMIQ (R&S® SMIQB60) and the I/Q Modulation Generators R&S® AMIQ. For the R&S® AMIQ, it provides file management on the internal hard disk, and controls the hardware settings and all other functions.

The functionality of R&S® WinIQSIM™ regarding device control is especially important in bit error rate measurements with the R&S® AMIQ (option R&S® AMIQ-B1). In addition to performing the control functions, the software outputs the measurement results in an R&S® WinIQSIM™ window.

## Specifications in brief

**You will find detailed and binding data on enclosed CD (./DATASHEET/WinIQSIM.pdf) or top current on our web page: [www.rohde-schwarz.com](http://www.rohde-schwarz.com), search term: WinIQSIM**

User interface	Windows interface with context-sensitive help
Systems	single-carrier, multicarrier, multicarrier mixed signal, 3GPP FDD, 3GPP TDD, TD-SCDMA, IS-95, cdma2000

### Single carrier

Simulation of digitally modulated single-carrier signals incl. TDMA	
Modulation modes	PSK
Parameter	BPSK, QPSK, offset QPSK, $\pi/4$ DQPSK, 8PSK, 8PSK EDGE reference level = -10 dB to 3 dB PSK rotation = 0 to $15 \times \pi/8$
QAM	16/32/64/256QAM
Parameter	reference level = -10 dB to 3 dB
FSK	MSK, 2FSK, 4FSK, GTFM
Parameter	modulation index = 0.1 to 12 GTFM, b = 0 to 1
User-specific modulation	definition of customized modulation modes (PSK, QAM, FSK) via data interface with up to 4.096 mapping states

### Multicarrier

Simulation of multicarrier signals with same or without modulation	
Number of carriers	max. 512 carriers
Parameters of each carrier	state on/off, power, modulation on/off, data source, start phase
Modulation modes	same as with single-carrier system, each carrier can be modulated or not, modulated carriers use the same modulation mode

### Multicarrier mixed signal

Simulation of differently modulated multicarrier signals and signals of different systems on the carriers	
Number of carriers	max. 32
Parameters of each carrier	state on/off, power, I/Q modulation file, start phase
I/Q modulation signal	an I/Q signal file onto which the carrier is to be modulated can be defined for each carrier; these signal files can be generated in all systems

### Digital standard 3GPP FDD

**with option R&S® SMU-K20/R&S® SMIQK20/R&S AMIQK20**

Release 5 to 3GPP Technical Specifications TS25.211, TS25.213, TS25.141, TS25.101 and TS25.104

#### General settings

Chip rate, standard	3.840 Mcps (15 slots/frame)
Chip rate, range	10 cps to 100 Mcps
Link direction	uplink (reverse link) and downlink (forward link)

### Digital standard 3GPP TDD

**with option R&S® SMU-K13/R&S® SMIQK13/R&S AMIQK13**

Simulation of signals to time division duplex wideband CDMA standard according to version 4.1.0 of the 3GPP Technical Specification TS 25.221, TS 25.223, available as Software Option R&S® SMU-K13 and internal Arbitrary Waveform Generator of Option R&S® SMU-B10 of the R&S® SMU or Software Option R&S® SMIQK13 and Arbitrary Waveform Generator Option R&S® SMIQB60 of the R&S® SMIQ or Software Option R&S® AMIQK13 of the R&S® AMIQ

#### General settings

Chip rate, standard	3.84 Mcps
Chip rate, range	see clock rates of R&S® SMU-B10/R&S® SMIQB60/R&S® AMIQ in the corresponding datasheets
Mode	downlink only: the base station components of a cell are active uplink only: the mobile station components of a cell are active downlink and uplink: both the base station and the mobile station components of a cell are active

### Digital standard TD-SCDMA

**with option R&S® SMU-K14/R&S® SMIQK14/R&S AMIQK14**

Simulation of signals according to time division synchronous CDMA standard of China Wireless Telecommunication Standard Group (CWTS), available as Software Option R&S® SMU-K14 and internal Arbitrary Waveform Generator of Option R&S® SMU-B10 of the R&S® SMU or Software Option R&S® SMIQK14 and Arbitrary Waveform Generator Option R&S® SMIQB60 of the R&S® SMIQ or Software Option R&S® AMIQK14 of the R&S® AMIQ

#### General settings

Chip rate	1.28 Mcps
Standard	
Range	see clock rates of R&S® SMU-B10/R&S® SMIQB60/R&S® AMIQ in the corresponding datasheets
Mode	downlink only: the base station components of a cell are active uplink only: the mobile station components of a cell are active downlink and uplink: both the base station and the mobile station components of a cell are active



## Simulation Software R&amp;S® WinIQSIM™

## Digital standard IS-95

## with option R&amp;S®SMU-K11/R&amp;S®SMIQK11/R&amp;S®AMIQK11

Simulation of CDMA signals to North American standard cdmaOne, available as Software Option R&S®SMU-K11 and internal Arbitrary Waveform Generator or Software Option R&S®SMIQK11 in conjunction with the Arbitrary Waveform Generator Option R&S®SMIQB60 of the R&S®SMIQ or Option R&S®SMU-B10 of the R&S®SMU or Software Option R&S®AMIQK11 of the R&S®AMIQ

## General settings

Chip rate, standard Range	1.2288 Mcps see clock rates of R&S®SMU-B10/R&S®SMIQB60/R&S®AMIQ in the corresponding datasheets
Link direction	forward link and reverse link

## Digital standard cdma2000

## with option R&amp;S®SMU-K12/R&amp;S®SMIQK12/R&amp;S®AMIQK12

Simulation of CDMA signals to North American standard IS-2000, available as Software Option R&S®SMU-K12 and internal Arbitrary Waveform Generator of Option R&S®SMU-B10 of the R&S®SMU or Software Option R&S®SMIQK12 in conjunction with the Arbitrary Waveform Generator Option R&S®SMIQB60 of the R&S®SMIQ or Software Option R&S®AMIQK12 of the R&S®AMIQ

## General settings

Chip rate, standard Range	1.2288 Mcps (1X), 3.6864 Mcps (3X) see clock rates of R&S®SMU-B10/R&S®SMIQB60/R&S®AMIQ in the corresponding datasheets
Carrier spacing, standard Variable	1.25 MHz R&S®AMIQ: 0 to 10 MHz, R&S®SMIQB60: 0 to 2 MHz
Modes	1X Direct Spread, 3X Direct Spread 3X Multi Carrier (forward link only)
Link direction	forward link and reverse link

## Digital standard 1xEV-DO

## with option R&amp;S®SMU-K17/R&amp;S®SMIQK17/R&amp;S®AMIQK17

Simulation of 1xEV-DO signals to North American Standard "cdma2000 High Rate Packet Data Air Interface Specification", available as Software Option R&S®SMU-K17 and internal Arbitrary Waveform Generator of Option R&S®SMU-B10 of the R&S®SMU or Software Option R&S®SMIQK17 in conjunction with the Arbitrary Waveform Generator Option R&S®SMIQB60 of the R&S®SMIQ or Software Option R&S®AMIQK17 of the R&S®AMIQ

## General settings

Chip rate, standard Range	1.2288 Mcps see clock rates of R&S®SMU-B10/R&S®SMIQB60/R&S®AMIQ in the corresponding datasheets
Link direction	forward link (simulation of up to 4 base stations) and reverse link (simulation of up to 4 mobiles)

## Digital standard IEEE 802.11(a,b,g) Wireless LAN

## with option R&amp;S®SMU-K19/R&amp;S®SMIQK19/R&amp;S®AMIQK19

Simulation of signals to Wireless LAN standard IEEE802.11, available as Software Option R&S®SMU-K19 and Option R&S®SMU-B10 of R&S®SMU or Software Option R&S®SMIQK19 and Option R&S®SMIQB60 Arbitrary Waveform Generator of R&S®SMIQ or Software Option R&S®AMIQK19 of R&S®AMIQ

The wireless LAN options R&S®SMU-K19/SMIQK19/AMIQK19 support CCK modulation to IEEE802.11b and 802.11g, OFDM modulation to IEEE802.11a and 802.11g as well as extended PBCC modes to IEEE802.11b and 802.11g.

## Settings valid for 11b, 11g and 11a

Simulation mode Framed mode	generation of a sequence of data packets with the frame structure defined by the standard, interrupted by an idle time
Unframed mode	generation of a non-packet-oriented signal without frame structure, with the modulation modes and data rates defined by the 802.11 standard
User data	same as with single-carrier system

## Import system

Import of I/Q data from other applications via a dynamic data exchange (DDE) interface or via TCP/IP; further processing in R&S®WinIQSIM™, e.g. baseband filtering or superposition of impairments

Baseband filtering	same as with single-carrier system
Sequence length	R&S®SMU-B10: 1 sample to max. 56 Msample R&S®SMIQB60: 1 sample to max. 524.216 Msample R&S®AMIQK11: 1 sample to max. 16 Msample
Simulation of impairments and transfer characteristics	same as with single-carrier system
Smoothing	same as with single-carrier system
Graphical output	same as with single-carrier system
ACP calculation	calculation of adjacent-channel power in spectrum display (ACP up, low and ACP up 1st alt, low 1st alt)
IF signal generation	modulation of calculated I/Q signal to IF in range 0.01 MHz to 25 MHz (output to I channel of R&S®AMIQ)

## Miscellaneous

Waveform transmission to R&S®AMIQ	interfaces: IEC/IEEE bus (GPIB), RS-232-C, floppy; conversion of I/Q signal to 14 bit R&S®AMIQ format: user-selectable clipping level (over- and underranging possible)
Remote control of R&S®AMIQ	download and starting of waveforms, hardware configuration, alignment and fine adjustment, file management, BER test
For data transfer	IEC/IEEE bus (GPIB): card (from National Instruments) with drivers, IEC/IEEE bus cable; RS-232-C null-modem cable
System requirements	PC, 50 Mbyte hard disk memory, mouse, monitor: 1024 × 768 pixels with 256 colours recommended

## Ordering information

<b>Baseband Generator with ARB</b> (56 Msample) and Digital Modulation	R&S®SMU-B10	1141.7007.02
<b>Internal Arbitrary Waveform Generator</b> in the R&S®SMIQ	R&S®SMIQB60	1136.4390.02
<b>I/Q Modulation Generator</b>	R&S®AMIQ	1110.2003.04
<b>Digital Standards</b>		
IS-95 (cdmaOne)	R&S®SMU-K11 R&S®SMIQK11 R&S®AMIQK11	1160.5335.02 1105.0287.02 1122.2003.02
cdma2000	R&S®SMU-K12 R&S®SMIQK12 R&S®AMIQK12	1160.5658.02 1105.0435.02 1122.2503.02
3GPP TDD	R&S®SMU-K13 R&S®SMIQK13 R&S®AMIQK13	1160.5906.02 1105.1231.02 1122.2603.02
3GPP FDD	R&S®SMU-K20 R&S®SMIQK20 R&S®AMIQK20	1160.9460.02 1400.5302.02 1400.5354.02
1xEV-DO	R&S®SMU-K17 R&S®SMIQK17 R&S®AMIQK17	1160.7009.02 1154.7800.02 1122.3000.02
TD-SCDMA	R&S®SMU-K14 R&S®AMIQK14 R&S®SMIQK14	1160.6202.02 1122.2703.02 1105.1383.02
OFDM Signal Generation	R&S®SMU-K15 R&S®AMIQK15 R&S®SMIQK15	1160.6402.02 1122.2803.02 1105.1531.02
IEEE802.11 (a,b,g)	R&S®SMU-K19 R&S®SMIQK19 R&S®AMIQK19	1160.8805.02 1154.8307.02 1122.3200.02



Contents Overview

Chapter Overview

Type Index

R&amp;S Addresses



## Dual-Channel Arbitrary/Function Generator R&amp;S®AM300

Arbitrary, function and  
I/Q generator

- 100 Msample/s
- DC up to 50 MHz

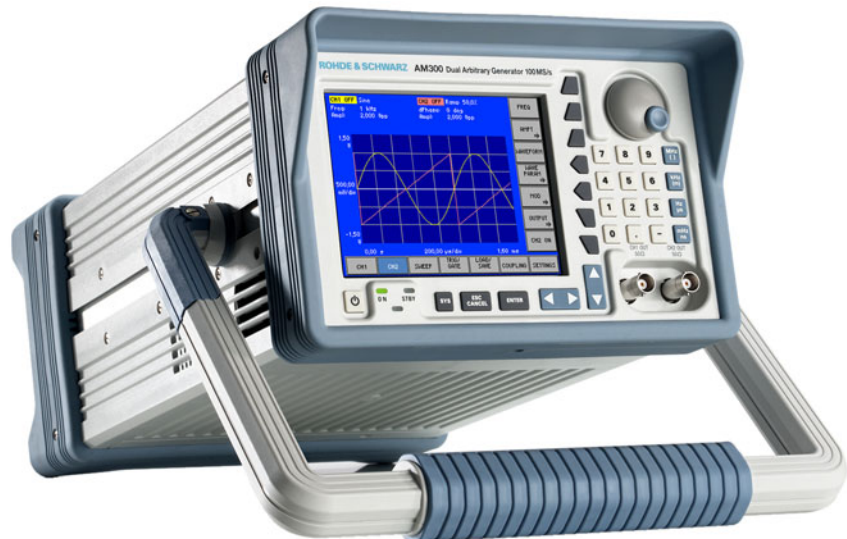
**New**

## Brief description

The R&S®AM300 is a dual-channel arbitrary/function generator that offers superb functionality and spectral purity at a favourable price. Due to its high-quality characteristics, the instrument displays digitally generated signals almost distortion-free – even at high output levels and frequencies. The R&S®AM300 thus meets reference signal source requirements for a host of applications.

With a high sampling rate of up to 100 Msample/s, 256k-point waveform memory per channel and the Waveform Composer software, virtually any waveform can be implemented – no matter whether for applications in the lab, in production or service.

The two channels of the instrument are phase-coupled and thus allow the generation of analog I/Q signals that can be used, for example, to modulate the RF Signal Generator R&S®SM300. The upper frequency limit of 35 Hz for sine signals

and 50 MHz for square signals leaves sufficient room for future tasks.

Operation is menu-guided so that even untrained users will quickly obtain correct results. Clear structures simplify navigation within the menus. The bright TFT colour display allows settings and results to be read even at odd angles or when the incidence of light is unfavourable.

## Main features

- ◆ Two channels with individually selectable frequency, waveform and amplitude
- ◆ Phase offset selectable with 0.01° resolution
- ◆ Harmonic suppression for sine signals (1 MHz), typically 70 dB (0.03%)
- ◆ Large colour display for displaying waveforms, including zoom function
- ◆ Highly stable reference frequency (1 ppm/year)
- ◆ Low-jitter clock generator up to 50 MHz
- ◆ USB interface (with file management on USB stick)

## Applications

- ◆ Generation of high-quality modulation signals
- ◆ Generation of two signals with precisely defined time and phase relationship
- ◆ Testing of control loops (e.g. AGCs)
- ◆ Generation of test signals, e.g. simulation of sensor signals including defined superimposed interference
- ◆ Replay of digitized data for reproduction of real signals
- ◆ Generation of I/Q modulation signals for generating a wide range of digitally modulated broadband signals
- ◆ Generation of pulses and bursts

The possible combinations offered by the two channels of the R&S®AM300 further increase the instrument's versatility.



Contents Overview

Chapter Overview

Type Index

R&amp;S Addresses



## Dual-Channel Arbitrary/Function Generator R&S® AM300

### Specifications in brief

You will find detailed and binding data on the enclosed CD (./DATASHEET/AM300.pdf), or, for the latest updates, visit [www.rohde-schwarz.com](http://www.rohde-schwarz.com), search term: **AM300**

<b>Channels</b>	2
Phase, setting range	
Operating modes	CH1, CH2, CH1+CH2
<b>Waveforms</b>	
Standard	sine, triangle, ramp, square, pulse, exponential rise, exponential fall, noise
Arbitrary	
Waveform length	16 to 262144 (256k) points per channel
Level resolution	14 bit
<b>Modulation</b>	
Modulation modes	AM, FM, φM, FSK, PSK
Frequency	
Sine	10 μHz to 35 MHz
Triangle, ramp, square, exponential	10 μHz to 500 kHz
Low-jitter square	10 μHz to 50 MHz
Noise	35 MHz bandwidth
Pulse	10 μHz to 16.667 MHz
<b>Arbitrary</b>	
Repetition rate	max. 6.25 MHz (16 points)
Sampling rate	10 μHz to 100 MHz
<b>Signal output</b>	
Protection	short-circuit-protected
Output voltage (into 50 Ω)	
Setting range with AM	1 mV to 10 V (V <sub>pp</sub> ); 1 mV to 5 V (V <sub>oo</sub> )
Resolution	0.1 mV (4 digits)
Frequency response, relative to 10 kHz sinewave, 10 μHz ≤ f ≤ 30 MHz	±0.1 dB
<b>Filters</b>	
Internal	manual, automatic
Cutoff frequencies of lowpass filters	35 MHz, 37 MHz, 75 MHz
Filter types	9th order Bessel, 9th order Cauer

Modulation	AM	FM	φM	FSK	PSK
<b>Carrier waveforms</b>					
Sine	•	•	•	•	•
Triangle	•	•	•	•	•
Square	•	•	•	•	•
Ramp	•	•	•	•	•
Exponential	•	•	•	•	•
Pulse	•				
Arbitrary	•	•	•	•	•
Noise	•				
<b>Modulation waveforms</b>					
Sine	•	•	•		
Triangle	•	•	•		
Square	•	•	•	•	•
Ramp	•	•	•		
Exponential	•	•	•		
Pulse					
Arbitrary					
Noise	•	•	•		
<b>Source</b>					
Internal/external	int.	int.	int.	int./ext.	int./ext.

<b>Modulation</b>	
AM, FM, φM modulation frequency	10 mHz to 100 kHz
AM modulation depth	0% to 100%
FM frequency deviation	100 mHz to 17.5 MHz
φM, PSK phase deviation	-180° to +180°
FSK, PSK modulation frequency	0.1 mHz to 2 MHz
FSK frequency deviation	10 μHz to 500 kHz (sine: 35 MHz)
<b>Spectral purity (sinewave)</b>	
Harmonic distortion, <3 V (V <sub>pp</sub> ), 20 Hz ≤ f ≤ 1 MHz	<-65 dBc
Nonharmonic distortion, 10 μHz ≤ f ≤ 5 MHz	typ. -70 dBc
SSB phase noise, 10 kHz offset from carrier, 10 MHz	-118 dBc (1 Hz)
<b>Signal characteristics</b>	
Square, duty cycle, ≤500 kHz	1% to 99% (selectable)
Square, duty cycle, 10 μHz to 50 MHz	50% (fixed)
Pulse period	70 ns to 9999 s
Pulse width	20 ns to 9999 s
Ramp/triangle, symmetry	0% to 100v
Exponential	rise or fall
Arbitrary rise time	<10 ns
Arbitrary loading time via USB	16 s (binary, 256k points)
<b>Gate/burst</b>	
Waveforms	sine, triangle, ramp, square, exponential, arbitrary
Gate settings	block end, sample & hold, burst
Number of cycles per burst	1 to 65535
Gate source	internal, external
<b>Sweep</b>	
Waveforms	sine, triangle, ramp, square, exponential, arbitrary
Type	linear, logarithmic
Sweep time	1 ms to 999 s
Marker	frequency marker
<b>Trigger</b>	
Source	manual, internal, external
Delay, setting range	0 ns or 150 ns to 9999 s
Internal trigger, repetition cycle	500 ns to 9901 s (2 MHz to 101 μHz)
Sync outputs	2

### General data

Display	5.4" active colour TFT, 320 × 240 pixels
USB host, USB device	Version 1.1
Additional memory	USB memory stick
Power supply	100 V to 240 V AC (autoranging), 50 Hz to 60 Hz
Power consumption	<35 VA
Operating temperature range	+5°C to +45°C
Dimensions (W × H × D)	219 mm × 147 mm × 350 mm
Weight	6.2 kg

### Ordering information

<b>Dual-Channel Arbitrary/Function Generator R&amp;S® AM300</b>		
(including PC software R&S®AM300-K1)	R&S®AM300	1147.1998.03
<b>Recommended extras</b>		
Waveform Composer (software, licensed for 5 instruments)	R&S®AM300-K2	1147.2013.02
Rack Adapter	R&S®ZZA-300	1147.1281.00

## Baseband Fading Simulator R&amp;S® ABFS

## Saving costs through real-world fading tests

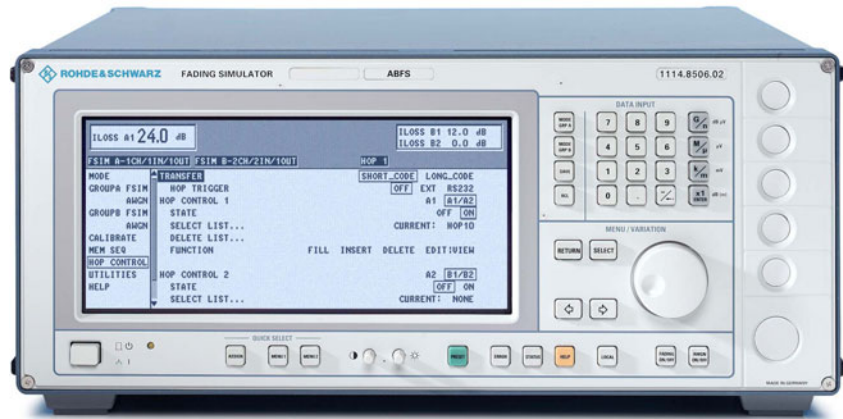

## Brief description

The characteristics of a radio channel may strongly impair signal transmission between a transmitter and in particular a moving receiver.

Baseband Fading Simulator R&S® ABFS generates signals which simulate real receive conditions in mobile applications. Thus, the response of receivers under real-world conditions can be checked already during development and QM acceptance testing. The simulation of fading signals at baseband level reduces costs.

Baseband Fading Simulator R&S® ABFS is suitable for universal mobile radio applications in research, development and production. It comprises all scenarios and statistical models for simulating sporadic fading as specified in the test regulations of mobile radio standards (e.g. GSM, IS-54/IS-136 or IS-95 CDMA).

The open concept of R&S® ABFS allows the simulation of radio channels of existing and future communication systems (e.g. mobile radio, broadcasting, flight telephone, WLL, or WLAN systems). R&S® ABFS can also simulate frequency hopping systems. The basic model of

R&S® ABFS comes with two independent channels for 6-path fading. The two channels can be interconnected as follows:

- ◆ Distribution of an input to two outputs (e.g. with different fading profiles). This feature makes it possible to simulate several antennas with different characteristics or frequency diversity methods
- ◆ Simulation of two inputs with individual profiles and addition at output. Cell change or superposition of interferers can be tested with this configuration
- ◆ Coupling of two channels so that a channel with 12 propagation paths is obtained

## Main features

- ◆ 2 fading channels (4 with option R&S® ABFS-B2)
- ◆ 12 propagation paths (24 with option R&S® ABFS-B2)
- ◆ Max. 12 propagation paths per channel
- ◆ Universal use in research, development and production
- ◆ Simulation of present and future communication systems thanks to open concept
- ◆ Receiver tests at I/Q level together with a baseband source

- ◆ Ease of operation
- ◆ High reliability

## Options

**Noise Generator R&S® ABFS-B1** adds a noise source to the output of the first channel so that noise can be simulated in the frequency band used. The noise generator can be switched on or off irrespective of the operating modes of the basic version.

**Second Fading Simulator**

**R&S® ABFS-B2** offers two extra channels with the same characteristics in addition to the two channels of the basic model.

**Second Noise Generator**

**R&S® ABFS-B3** represents an additional noise source for a further output. This second noise generator is either assigned to the second channel of the basic R&S® ABFS (with first noise generator R&S® ABFS-B1 for the first channel) or to the first channel of the second fading simulator R&S® ABFS-B2. Fading profiles of the Rayleigh, Rician, Pure Doppler, log-normal or Suzuki method can be assigned to each of the propagation paths irrespective of the selected circuit. In addition to the fading profiles mentioned, the following parameters can be defined for each propagation path:

## Baseband Fading Simulator R&amp;S® ABFS

- ◆ Path attenuation
- ◆ Delay time
- ◆ Doppler frequency or speed between transmitter and receiver
- ◆ Coupling to another channel

Many fading models (e.g. GSM Rural Urban, Typical Urban) have already been programmed in R&S® ABFS. The user can quickly recall these default settings and also modify the parameters.

### Enhanced fading functions for WCDMA 3GPP with option R&S® ABFSB49

R&S® ABFSB49 extends the functionality of the baseband fading simulator R&S® ABFS to include WCDMA 3GPP channel simulation. It adds three new modes to the fading simulator so that all scenarios defined in 3GPP Release 99 can be simulated:

- ◆ In fine delay mode, fading simulator resolution is increased to 1 ns with up to four paths being available
- ◆ In moving delay mode, two paths are simulated: for one path the delay remains constant, whereas for the other path the delay varies continuously
- ◆ In birth-death mode, there are two paths changing delay in steps in accordance with the 3GPP channel model

## Specifications in brief

You will find detailed and binding data on enclosed CD (./DATASHEET/ABFS.pdf) or top current on our web page: [www.rohde-schwarz.com](http://www.rohde-schwarz.com), search term: ABFS

Fading simulation	
Number of propagation paths and fading channels	1 channel with 12 paths or 2 channels with 6 paths each
Basic model with option R&S® ABFS-B2	2 channels with 12 paths each or 4 channels with 6 paths each
Insertion loss between input and output at 0 dB path attenuation	min. 9 dB
Path attenuation	0 dB to 50 dB
Path delay	0 μs to 1600 μs
Doppler shift, frequency range	0.1 Hz to 1600 Hz
Doppler shift, speed range, for example at $f_{RF} = 1$ GHz	$v_{min} = 0.1$ km/h, $v_{max} = 1724$ km/h
Rayleigh fading	
Pseudo noise interval	>372 h
Rice fading, power ratio	-30 dB to +30 dB
Rice fading, frequency ratio	-1 to +1
Lognormal fading, Suzuki fading	
Standard deviation, range	0 dB to 12 dB
Correlation	paths 1 to 6 with paths 7 to 12 of a channel (A or B)
Frequency hopping mode	RF can be stored in a list and quickly set via a serial interface
Setting time after frequency change during Rayleigh fading	<3.5 ms
Noise generator with options R&S® ABFS-B1 or R&S® ABFS-B3	
Amplitude distribution	Gaussian, statistically independent for I and Q
Crest factor	14 dB
Noise power level in relation to full-scale level, range	-17 dBfs to -50 dBfs
Insertion loss input/output	0 dB, 6 dB, 12 dB to 42 dB
Output spectrum	white noise
Bandwidth	depending on set system bandwidth
RF system bandwidth <sup>3)</sup>	bandwidth determining noise power
Setting range	10 kHz to 10 MHz

### Enhanced Fading Functions for WCDMA 3GPP R&S® ABFSB49

The enhanced fading functions for WCDMA 3GPP are only available for the R&S® ABFS standard fading simulator, not for the second fading simulator (option R&S® ABFS-B2).

Modes	Standard fading, fine delay, birth-death
Setting time after RF frequency change	6 ms
Fine delay mode	
RF bandwidth	4.8 MHz
Number of paths	4
Profiles	Rayleigh, pure Doppler
Moving delay mode	
RF bandwidth	4.8 MHz
Number of paths	2
Birth-death mode	
Number of paths	2
Profiles	pure Doppler
General data	
Memory for device settings	50
Remote control	IEC625 (IEEE488)
Power supply	90 V to 132 V (AC), 47 Hz to 440 Hz, 180 V to 265 V (AC), 47 Hz to 440 Hz, autoranging, max. 300 VA
Operating temperature range	0°C to 45°C
Dimensions (W × H × D)	435 mm × 192 mm × 460 mm
Weight	20 kg when unit is fully equipped

## Ordering information

Baseband Fading Simulator	R&S® ABFS	1114.8506.02
Accessories supplied	power cable, operating manual	
Options		
Noise Generator	R&S® ABFS-B1	1115.0009.02
Second Fading Simulator	R&S® ABFS-B2	1115.0309.02
Second Noise Generator	R&S® ABFS-B3	1115.0609.02
Fading for 3GPP	R&S® ABFSB49	1115.0909.02
Extras		
19" Rack Adapter	R&S® ZZA-94	0396.4905.00
Service Kit	R&S® SM-Z3	1085.2500.02
Trolley	R&S® ZZK-1	1014.0510.00
Transit Case	R&S® ZZK-944	1013.9366.00
Service Manual	R&S® ABFS	1114.8564.94



Contents Overview

Chapter Overview

Type Index

R&S Addresses

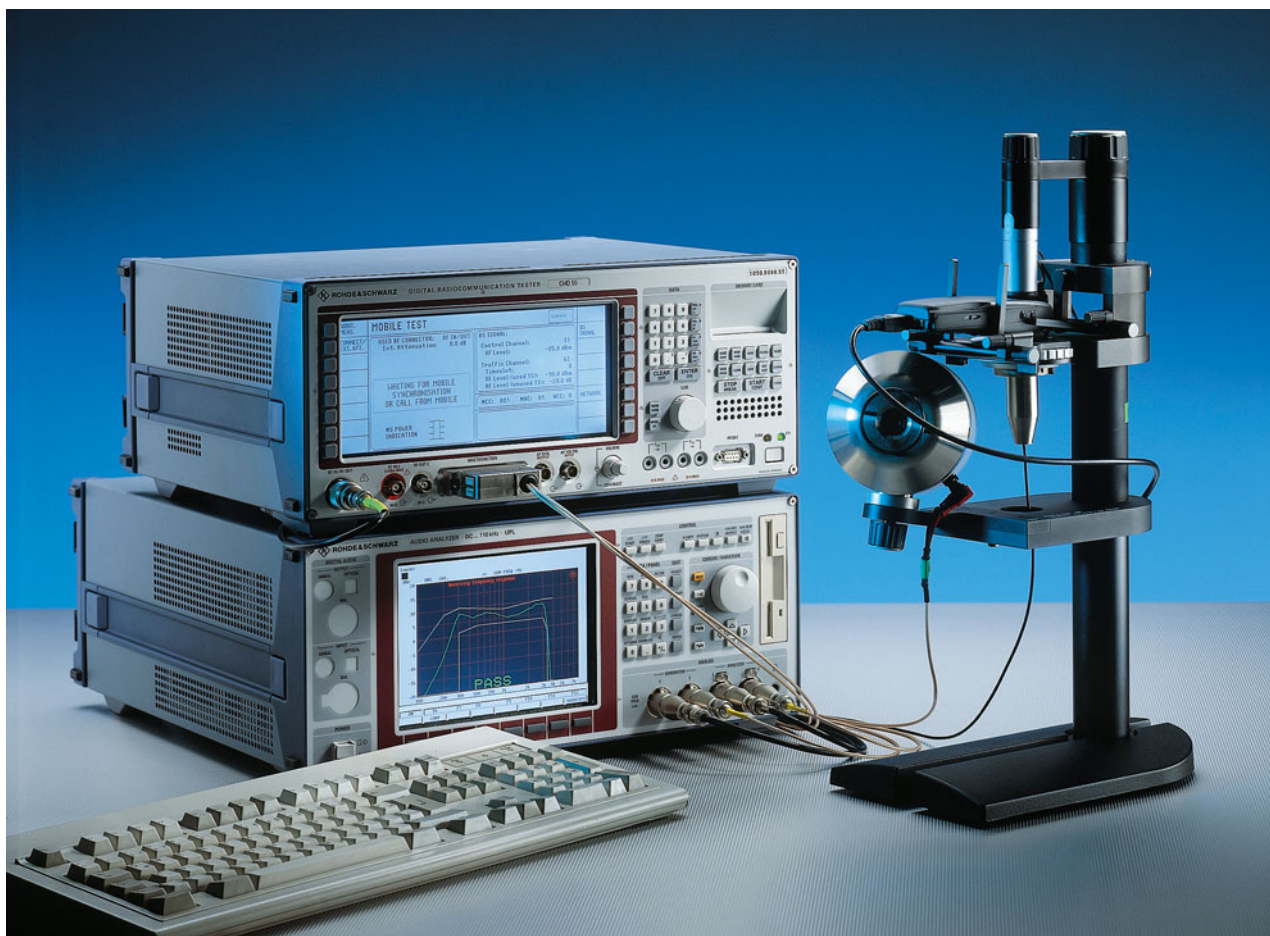

*Audio Analyzer R&S® UPL 16 for acoustic measurements on mobile phones to 3GPP TS 51.010*



Contents Overview

Chapter Overview

Type Index

R&S Addresses





Contents Overview

Chapter Overview

Type Index

R&amp;S Addresses



## Contents of Chapter 6

Designation	Type	Frequency range	Description	Page
<b>Audio Analyzers</b>	R&S®UPL	DC to 110 kHz	Compact instrument for audio measurements at analog and digital interfaces; highest measurement accuracy thanks to digital signal processing throughout; programmable filters and digital interfaces; FFT with zoom function (max. 0.05 Hz resolution); further processing of results with standard software	272
	R&S®UPL16	DC to 110 kHz	Same as UPL, special model for type-approval measurements on GSM mobiles	
	R&S®UPL66	DC to 110 kHz	Same as UPL, but without display and keyboard	
<b>Test System for Hearing Aids</b>	R&S®UPL + R&S®UPL-B7	DC to 110 kHz	Measurements on hearing aids to EN60118 or ANSI S3.22	275
<b>Coded Audio Signal Generation</b>	R&S®UPL-B23	5.2083 Hz to 20 kHz	Multichannel audio measurements on surround sounddecoders	277
<b>Audio Switcher</b>	R&S®UPZ		Multichannel audio measurements on surround sound decoders	277
<b>Audio Analyzer</b>	R&S®UPV		Compact instrument for all audio measurements	279
<b>VOR/ILS Receiver/Analyzer</b>	R&S®EVS200	VOR/ILS	Versatile analyzer for air traffic control	281
<b>Modulation Analyzers</b>				283
Modulation Analyzer	R&S®FMA	50 kHz to 1360 MHz	Universal analyzer for AM, FM and $\phi$ M; high precision and extremely low phase noise	
Modulation Analyzer	R&S®FMAB	50 kHz to 1360 MHz	Analyzer for VHF FM stereo broadcast signals; with decoder, weighting filters and SINAD/distortion meter	
Selective Modulation Analyzer	R&S®FMAS	5 MHz to 1000 MHz	Off-air measurements on VHF FM and TV dual-sound transmitters, modulation analysis of VHF FM and TV sound signals, FM stereo relay reception; extremely high sensitivity and receive quality	
Modulation Analyzer	R&S®FMAV	50 kHz to 1360 MHz	Same as R&S®FMA; but especially for measurements on VOR/ILS equipment	
Modulation Analyzer	R&S®FMB	50 kHz to 5.2 GHz	Same as R&S®FMA, but up to 5.2 GHz and with higher accuracy of RF power measurement	



Contents Overview

Chapter Overview

Type Index

R&amp;S Addresses



## Audio Analyzer R&amp;S®UPL

## DC to 110 kHz

Compact instrument for audio measurements at analog and digital interfaces

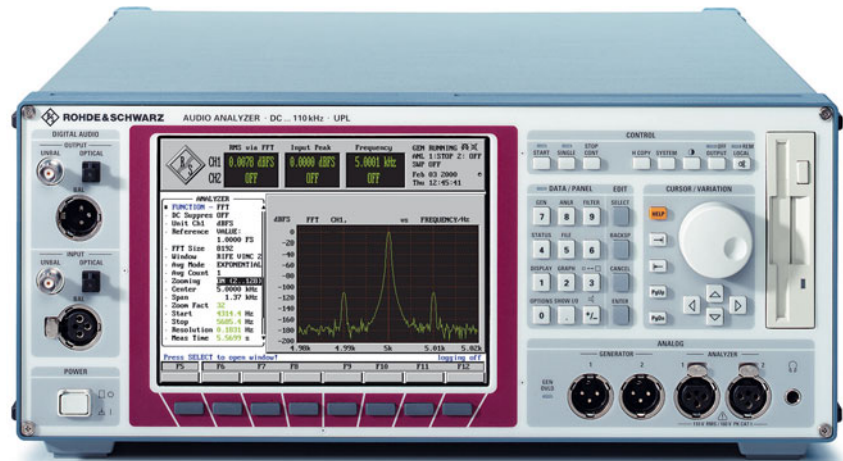

## Brief description

Audio Analyzer R&S®UPL comprises analyzers and generators for dual-channel measurements and generation of a wide variety of analog and digital audio signals. Its measurement functions and signals are available at all interfaces so that all input-output combinations (AA, AD, DA, DD) are possible. An option allows comprehensive tests of the physical parameters of the audio interfaces, including jitter amplitude and spectrum, pulse amplitude, difference and delay with respect to a reference input.

R&S®UPL is thus suitable for all types of audio measurement. Particular emphasis was placed on high measurement speed, which is a must in automatic testing in production.

## Main features

- ◆ Compact instrument with integrated PC and colour or monochrome LC display
- ◆ Wide variety of test functions and numerous test signals for performing virtually all measurement tasks
- ◆ Versatile analysis thanks to internal FFT analyzer of wide dynamic range and high frequency resolution
- ◆ Future-proof: new test functions can be loaded from diskette
- ◆ Any number of digital filters, also for analog measurements
- ◆ Max. dynamic range for analysis of high-grade components
- ◆ Intelligent operator guidance and context-sensitive help system
- ◆ Mnemonic analysis and generation of channel status data of digital audio interfaces
- ◆ Measurement/generation of protocol errors at digital interfaces
- ◆ Variety of sweep functions
- ◆ More than 10 weighting filters
  - highpass, lowpass, bandpass filters

## Overview of options

Designation, functions	Option
<b>Low Distortion Generator</b> Analog sinuswave generator offering lower inherent distortion and wider frequency range than built-in standard generator	R&S®UPL-B1
<b>Digital Audio I/O</b> Contains the balanced, unbalanced and optical digital audio interfaces with clock rate up to 48 kHz	R&S®UPL-B2
<b>Digital Audio I/O</b> Same as R&S®UPL-B2, but clock rate up to 96 kHz	R&S®UPL-B29
<b>Extended Analysis Functions</b> Coherence and transfer functions, rub & buzz measurement, third-octave analysis	R&S®UPL-B6
<b>Digital Audio Protocol</b> With Digital Audio I/O fitted, this option allows the generation and analysis of additional digital data such as channel status and user data, validity bits and the evaluation of parity bits	R&S®UPL-B21
<b>Jitter and Interface Test</b> With Digital Audio I/O fitted, this option enables the physical parameters of digital audio interfaces to be examined	R&S®UPL-B22
<b>Coded audio Signal Generation</b> Generation of coded audio signals for audio measurements at surround decoders	R&S®UPL-B23
<b>Remote Control</b> Enables remote control via the RS-232-C interface or the IEC/IEEE-bus interface (IEC 625/IEEE 488)	R&S®UPL-B4
<b>Audio Monitor</b> Adds a headphones output and a built-in loudspeaker to R&S®UPL	R&S®UPL-B5
<b>Hearing Aids Test Accessories</b>	R&S®UPL-B7
<b>Mobile Phone Test Set</b> Measures the acoustic characteristics of mobile phones	R&S®UPL-B7
<b>3G Mobile Phone Tests</b> Acoustic measurements on mobile phones to 3GPP Standards	R&S®UPL-B9
<b>Universal Sequence Controller</b> Enables measurement sequences to be generated and executed with the aid of a built-in program generator	R&S®UPL-B10
<b>LAN Interface</b> Connects the R&S®UPL to Novell networks for data transfer	R&S®UPL-B11
<b>Automatic Audio Line Measurement</b> Enables measurement of broadcast links according to ITU-T 0.33 recommendations (R&S®UPL-B10 required)	R&S®UPL-B33





Contents Overview

Chapter Overview

Type Index

R&S Addresses



## Audio Analyzer R&S®UPL

### Specifications in brief

You will find detailed and binding data on the enclosed CD (./DATASHEET/UPL.pdf), or, for the latest updates, visit [www.rohde-schwarz.com](http://www.rohde-schwarz.com), search term: UPL

All inherent distortion values refer to the frequency range 20 Hz to 22 kHz.

### Analyzers

<b>Analog inputs</b>	
Balanced, floating	2 channels, 300 Ω/600 Ω/200 kΩ
Voltage measurement range	0.1 μV to 110 V rms
Common-mode rejection	>100 dB (50 Hz)
Frequency range	DC to 110 kHz
Frequency response	±0.03 dB, 20 Hz to 22 kHz
<b>Digital inputs</b>	
Digital Audio I/O option	
Balanced input	XLR connector, 110 Ω
Unbalanced input	BNC connector, 75 Ω
Optical input	Toslink system
Clock rate	35 kHz to 55 kHz (R&S®UPL-B2) 35 kHz to 106 kHz (R&S®UPL-B29)
Frequency range	10 Hz to 45.7% of clock rate
<b>Measurement functions of analog analyzers; digital analyzers in italics (option R&amp;S®UPL-B2 or R&amp;S®UPL-B29)</b>	
AF level	
Noise (600 Ω)	1.6 μV (CCIR unweight.); <i>-180 dBFS</i>
Weighting	RMS, peak <sup>1)</sup> , quasi-peak (CCIR 468) <sup>1)</sup>
Filters	weighting filter; HP, LP, BP; user-configurable in terms of cutoff frequency/attenuation; max. 3 filters can be combined
Selective level	
Center frequency	selectable/swept/coupled to generator or input frequency
Bandwidth (0.1 dB)	1%/3%/third octave <sup>1)</sup> /12 octave/ selectable
Total harmonic distortion (THD)	
Fundamental	10 Hz to 22 kHz
Inherent distortion (Σ 2nd to 9th order)	<i>-120 dB<sup>2)</sup>; -130 dB<sup>2)</sup></i>
SINAD and THD+N	
Fundamental	20 Hz to 22 kHz
Inherent distortion	<i>-110 dB<sup>2)</sup>; -126 dB<sup>2)</sup></i>
Filters	HP, LP + weighting filter
Modulation distortion	
Measurement method	selective to DIN IEC 268-3
Inherent distortion	<i>-100 dB; -123 dB<sup>2)</sup></i>
Difference-frequency distortion	
Measurement method	selective to DIN IEC 268-3
Inherent distortion d2	<i>-120 dB; -130 dB<sup>2)</sup></i>
d3	<i>-100 dB<sup>2)</sup>; -130 dB<sup>2)</sup></i>
Wow and flutter <sup>1)</sup> , meas. method	
Frequency	10 Hz to 110 kHz, <i>20 Hz to 20 kHz</i>
Phase, group delay	20 Hz to 20 kHz
Polarity test	0 V to ±110 V; <i>0 to ±FS</i>
DC voltage	memory depth 7424 points
Waveform (2-channel)	0 V to ±110 V; <i>0 to ±FS</i>
<b>FFT analyzer</b>	
Frequency range	DC to 110 kHz; <i>DC to 45.7% of clock rate</i>
FFT size/resolution	16 k points/0.023 Hz

Window functions	rectangular/Hann/Blackman-Harris/Rife-Vincent 1 to 3/Hamming/flat-top/Kaiser
Averaging	max. 256-fold, exp. + linear
Noise floor	-140 dB; <i>-160 dB</i>

**Filter**  
For all analog and digital analyzers. Up to 3 filters can be combined as required. All filters are digital filters with a coefficient accuracy of 32 bit floating point (exception: analog notch filter).  
Weighting filters, user-definable filters, analog notch filter (for detailed information see data sheet)

- 1) Not in whole frequency range.
- 2) Total inherent distortion of generator and analyzer.

### Generators

<b>Analog outputs</b>	
Balanced, floating	2 channels, 10 Ω/200 Ω/600 Ω
Output voltage	0.1 mV to 20 V rms (no load)
Unbalanced, floating	2 channels, 5 Ω
Output voltage	0.1 mV to 10 V rms (no load)
Frequency range	2 Hz to 21.75 kHz, sine up to 110 kHz <sup>1)</sup>
Frequency response	±0.05 dB, 20 Hz to 20 kHz
Inherent distortion <sup>1)</sup>	<i>-120 dB</i>
<b>Digital outputs</b>	
same as digital inputs	
<b>Generator functions of analog generators; digital generators in italics (option R&amp;S®UPL-B2 or R&amp;S®UPL-B29)</b>	
Sinewave	
Inherent THD	<i>-120 dB<sup>1)</sup>; -130 dB</i>
Inherent THD+N	<i>-110 dB<sup>1)</sup>; -126 dB<sup>1)</sup></i>
Signal for modulation distortion analysis, selectable	signal/interf. freq., amplitude ratio
Inherent distortion	<i>-100 dB; -123 dB<sup>1)</sup></i>
Difference-frequency signal, select	center frequency and frequency offset
Inherent distortion d2	<i>-120 dB; -130 dB<sup>1)</sup></i>
d3	<i>-100 dB<sup>1)</sup>; -130 dB<sup>1)</sup></i>
Multisine, selectable	amplitude/frequency; max. 17 frequencies
Sine-burst, sine <sup>2</sup> burst	level ratio and duty cycle selectable
Noise	flat/Gaussian/triangular distribution
Multifrequency noise	band-limited/white/pink/user-defined
Arbitrary waveform	any waveform from file
Max. number of points	16 k
Polarity test signal	Sine <sup>2</sup> burst
Sweeps	frequency, amplitude, burst interval, burst duration, time

<sup>1)</sup> Only with built-in Low Distortion Generator R&S®UPL-B1.

### Sweep

<b>Generator sweep</b>	
Parameters	frequency, level, with bursts also interval + duration, one- or two-dimensional
Sweep	linear, logarithmic, tabular, single, continuous, manual
Stepping	automatic after end of measurement time delay (fixed or loaded table)
<b>Analyzer sweep</b>	
Parameters	frequency or level of input signal
Sweep	single, continuous



Contents Overview

Chapter Overview

Type Index

R&S Addresses





Contents Overview

Chapter Overview

Type Index

R&amp;S Addresses



## Audio Analyzer R&amp;S®UPL

## Further options

## Digital Audio Protocol R&amp;S®UPL-B21

## Generator

Validity bit	NONE, L, R, L+R
Channel status data	mnemonic entry with user-defin. masks, predefined masks for professional and consumer format to AES3 or IEC-958
User data	loaded from file (max. 384 bits) or set to zero

## Analyzer

Display	validity bit L and R
Error indication	block errors, sequence errors, clock rate errors, preamble errors
Clock rate measurement	50 ppm
Channel status display	user-defin. mnemonic display of data fields, predefined settings for professional and consumer format to AES3 or IEC-958, binary and hexadecimal format
User bit display	user-definable mnemonic display, block-synchronized

## Jitter and Interface Test R&amp;S®UPL-B22

## Generator

Jitter injection	0 UI to 5 UI, 10 Hz to 21.75 kHz
Common mode signal	0 V to 20 V <sub>Vpp</sub> , 20 Hz to 21.75 kHz
Phase (output to reference)	0 UI to ±64 UI, selectable
Cable simulator	100 m audio cable

## Analyzer

Input signal	amplitude, sampling rate
Jitter measurement	amplitude, frequency, spectrum, relocking
Common mode test	amplitude, frequency, spectrum
Phase (input to reference)	0 to ±64 UI
Delay (input to output)	100 μs to 500 ms

## Extended Analysis Functions R&amp;S®UPL-B6

Coherence and transfer functions	can be displayed simultaneously
Averaging	2 to 2048
FFT length	256, 512, 1k, 2k, 4k, 8k points
Rub & buzz measurement	simultaneous measurement of frequency response, rub & buzz and polarity
Tracking highpass filter	2 to 20 times fundamental
Lower/upper frequency limit	selectable
Measurement time	2 s (200 Hz to 20 kHz, 200 points log.)
Multisine generator function	extended functions
Mode 1	crest factor or phase of each component selectable
Mode 2	crest factor selectable
Third octave analysis	for analyzer ANLG 22 kHz and digital 48 kHz
Number of third octaves	32
Stereo sine	in digital generator only

## Hearing Aids Test Accessories R&amp;S®UPL-B7

Consisting of acoustic test chamber, acoustic 2 cm<sup>3</sup> coupler, various battery adapters, connecting cables, software for measurements to IEC60118 and ANSI S3.22

Additional requirements	options R&S®UPL-B5 and R&S®UPL-B10
-------------------------	------------------------------------

## LAN Interface for R&amp;S®UPL06/66 (option R&amp;S®UPL-B11)

Connector (rear panel)	RJ45
Supported standards	10Base-T, 100Base-Tx
LAN client	Novell Netware
Supported protocols	IPX, TCP/IP

## General data

## Graphical display of results

Monitor (not R&S®UPL66) 8.4" LCD, colour display, display of any sweep trace, display of trace groups bargraph display with min./max. values spectrum, also as waterfall display list of results bar charts for THD and intermodulation measurements

## Display functions

Autoscale, axis zoom, full-screen and part-screen mode, 2 vertical, 1 horizontal cursor line, search function for max. values, marker for harmonics (spectrum) user-labelling for graphs, change of unit and scale also possible for loaded traces

## Test reports

Screen copy to printer, plotter or file (PCX, HPGL, Postscript). Lists of results: sweep lists, tolerance curves, list of out-of-tolerance values, equalizer traces

## Storage functions

Instrument settings, optionally with measured values and curves: spectra, sweep results, sweep lists, tolerance curves, equalizer traces

## Other data

Interface	RS-232-C, Centronics
Remote control	IEC625-2 (option R&S®UPL-B4)
Operating temperature range	0°C to +45°C
Power supply	100/120/220/230 V ±10%, 50 to 60 Hz, 160 VA
Dimensions (W × H × D); weight	435 mm × 192 mm × 475 mm; 12.6 kg

## Ordering information

## Audio Analyzer

with colour LCD	R&S®UPL06	1078.2008.06
without display and keyboard	R&S®UPL66	1078.2008.66
GSM model	R&S®UPL16	1078.2008.16

## Options

Low Distortion Generator	R&S®UPL-B1	1078.4400.02
Digital Audio I/O 48 kHz	R&S®UPL-B2	1078.4000.02
Digital Audio I/O 96 kHz	R&S®UPL-B29	1078.5107.02
Remote Control	R&S®UPL-B4	1078.3804.02
Audio Monitor	R&S®UPL-B5	1078.4600.03
Extended Analysis Functions	R&S®UPL-B6	1078.4500.02
Hearing Aids Test Accessories	R&S®UPL-B7	1090.2704.02
Mobile Phone Test Set	R&S®UPL-B8 <sup>1)</sup>	1117.3505.02
UMTS/GSM Mobile Phone Test Cases (software, transformer, adaptor)	R&S®UPL-B9 <sup>1)</sup>	1154.7500.03
Universal Sequence Controller	R&S®UPL-B10	1078.3904.02
LAN Interface for R&S®UPL06/66	R&S®UPL-B11	1154.7600.02
Digital Audio Protocol	R&S®UPL-B21 <sup>2)</sup>	1078.3856.02
Jitter and Interface Test	R&S®UPL-B22 <sup>2)</sup>	1078.3956.02
Coded Audio Signal Generation	R&S®UPL-B23 <sup>3)</sup>	1078.5188.02
Automatic Audio Line Measurement	R&S®UPL-B33 <sup>3)</sup>	1078.4852.02
150 Ω Modification	R&S®UPL-U3	1078.4900.02
R&S®UPL16 Upgrade Mobile Phone Tests (GSM-Release 99 with CMU)	R&S®UPL-U81	1154.7900.02
XLR/BNC Adapter Set	R&S®UPL-Z1	1078.3704.02

## Recommended extras

19" Rack Adapter	R&S®ZZA-94	0396.4905.00
Service manual		1078.2089.24

<sup>1)</sup> Option R&S®UPL-B6 and R&S®UPL-B10 required.

<sup>2)</sup> Option R&S®UPL-B2 or R&S®UPL-B29 required.

<sup>3)</sup> Option R&S®UPL-B10 required.



Contents Overview

Chapter Overview

Type Index

R&amp;S Addresses





Contents Overview

Chapter Overview

Type Index

R&amp;S Addresses



## Test System for Hearing Aids R&S®UPL + R&S®UPL-B7

### Measurements on hearing aids to EN 60118 or ANSI S3.22

#### Brief description

Audio Analyzer R&S®UPL (see data sheet PD 0757.2238) in conjunction with option R&S®UPL-B7 is a complete test system for all standard measurements on hearing aids. To carry out such measurements, R&S®UPL only requires the options Audio Monitoring (R&S®UPL-B5) and Universal Sequence Controller (R&S®UPL-B10).

The test system meets all the requirements relevant in the production, quality management and service of hearing aids. The HEARPRO software supplied with the system allows the user to generate test routines tailored to the specific characteristics of the device under test. The type and sequence of measurements are freely selectable. All test parameters can be accurately defined.

#### Option R&S®UPL-B7 includes

- ◆ a compact acoustic test chamber
- ◆ a complete set of cables
- ◆ a 2 cm<sup>3</sup> coupler with built-in microphone and calibration adapter
- ◆ a set of battery adapters for all commercial battery sizes for DUT power supply

Calibration of the complete test setup requires a sound level calibrator and a

*Test setup with acoustic test chamber*



test microphone which are not part of the equipment supplied.

#### For all relevant measurements

The convenient HEARPRO test software supplied with the system can handle measurements according to standards EN 60118 or ANSI S3.22-1996. All standard measurements can be carried out:

- ◆ SSPL curves
- ◆ adjustment to reference gain
- ◆ OSPL curves
- ◆ equivalent inherent noise
- ◆ THD at selectable frequencies
- ◆ battery current drain
- ◆ output sound pressure as a function of input sound pressure
- ◆ attack and release times of units using AGC
- ◆ groups of curves, e.g. for displaying the effect of frequency response setting at selectable sound pressure levels

- ◆ settings for telecoil measurements on hearing aid
- ◆ OSPL curve with telecoil
- ◆ THD with telecoil

#### Powerful in production

The high measurement speed of the system makes for high throughput in production applications. This can be further optimized by adapting the measurement speed to the DUT response.

Frequency response measurements and test results can be subjected to automatic tolerance checks. The results of these checks are documented and stored as PASS or FAIL results together with all test curves. This ensures consistent production quality. The clear-cut logging of all measurements facilitates evaluation of relevant parameters.



Contents Overview

Chapter Overview

Type Index

R&amp;S Addresses



## Test System for Hearing Aids R&S®UPL + R&S®UPL-B7

**Fast Hearing Aid Test with Rohde & Schwarz Audio Analyzer UPL**

According to IEC 118

	Setting max Gain:	Setting ref Gain:	Setting Telecoil:
Max OSPL90/OSPL90:	112.4 dB	112.5 dB	101.7 dB
OSPL90/OSPL90 REF:	101.8 dB	101.9 dB	89.8 dB
Maximum gain @ 60dB:	37.6 dB	37.7 dB	
Gain @ 60 dB @ REF:	27.3 dB	27.3 dB	
Maximum gain @ 50dB:	37.4 dB	37.5 dB	
Gain @ 50 dB @ REF:	27.3 dB	27.2 dB	
Equiv. Imp. Noise @ 60 dB:		24.7 dB	
THD 500 Hz @ 70 dB/ 100 mA/m:		6.9 %	14.2 %
THD 800 Hz @ 70 dB/ 100 mA/m:		1.5 %	6.1 %
THD 1600 Hz @ 70 dB/ 100 mA/m:		1.7 %	2.9 %
Battery Current idle/sound:	0.81 mA / 0.81 mA		
Attack Time:	0.5 ms		
Release Time:	4 ms		

F5 F6 F7 F8 F9 F10 F11 F12  
BACK NEXT REPEAT GRAPH SAVE SER. NO. REPORT

REF at 90 dBspl 98.9 dBspl

Adjust Hearing Aid to REF -15 dB

or to -7 dB below max. Gain if not adjustable

Continue with <SP6CE>

OFF F6 F7 F8 F9 F10 F11 F12  
DONE

**Hearing Aid Test with Rohde & Schwarz Audio Analyzer UPL**

Test: iec1.tst Standard: EN 60118-7 - 1993

Device under Test: Tested by: Mustermann Date: 07-08-97

Manufacturer: Audio Systems Model: Audimax5 Time: 11:21

Serial No: 001 Circ/Rev: Spec.1/1.0

Measuring Results:

REP @ 1600 Hz	Setting max Gain:	Setting ref Gain:	Setting Telecoil:
Max OSPL90/OSPL90:	124.4 dB @ 993 Hz	122.6 dB @ 993 Hz	106.2 dB @ 993 Hz
OSPL90/OSPL90 @ REF:	109.9 dB	107.8 dB	96.5 dB
Max. Gain @ 60 dB:		46.5 dB @ 993 Hz	66.6 dB @ 1000 Hz
Gain @ 60 dB @ REF:		35.6 dB	
Max. Gain @ 50 dB:		46.5 dB @ 997 Hz	
Gain @ 50 dB @ REF:		35.3 dB	
Equiv. Imp. Noise:		38.3 dB	
THD 500 Hz @ 70 dB/ 100 mA/m:		2.4 %	3.6 %
THD 800 Hz @ 70 dB/ 100 mA/m:		1.3 %	1.3 %
THD 1600 Hz @ 70 dB/ 100 mA/m:		1.1 %	1.9 %
Battery Current idle/sound:	0.98 mA / 1.04 mA		
Attack Time:	22.5 ms		
Release Time:	85 ms		

Screen display of results (left top), setting aid for acoustic gain of hearing aid (left bottom) and log printout (right)

Adapter for behind-the-ear (BTE) hearing aids   
 Adapter for in-the-ear (ITE) hearing aids   
 Adapter for body-worn hearing aids   
 Adapter for calibration of coupler

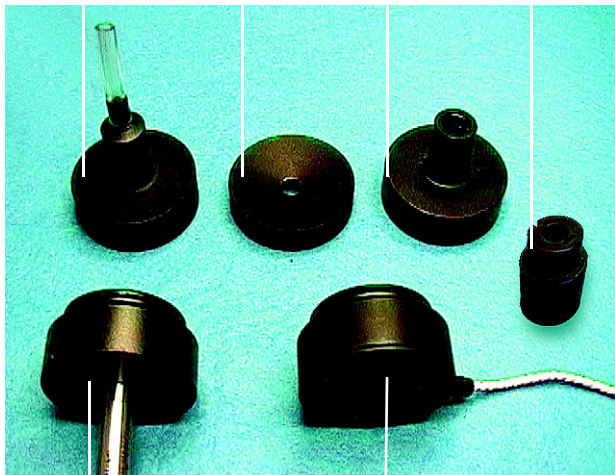

Coupler for 1/4" microphone (microphone not supplied)

Coupler with built-in microphone

## Specifications for R&S®UPL with R&S®UPL-B7

Max. sound pressure	>100 dB SPL, typ. 110 dB SPL
THD	<0.3% for 90 dB SPL
Ambient noise attenuation	>40 dB (20 Hz to 1500 Hz) >45 dB (>1500 Hz)
Frequency response of acoustic chamber without correction	±2 dB (100 Hz to 8000 Hz)
Feedthroughs for	<ul style="list-style-type: none"> <li>– microphone connector for coupler</li> <li>– with built-in microphone</li> <li>– battery adapter</li> <li>– 2 × 5-contact Mini-DIN for Hi-Pro programmer and 1/4" microphone preamplifier (GRAS 26 AC-R can be used)</li> </ul>
Dimensions of acoustic chamber (W × H × D)	365 mm × 260 mm × 400 mm
Weight	22 kg

## Coded Audio Signal Generation R&S®UPL-B23, Audio Switcher R&S®UPZ

### Multichannel audio measurements on surround sound decoders

#### Brief description

##### Previous method

Up to now, measuring surround decoders necessarily involved defining and storing coded test sequences on a DVD or the PC hard disk. The DVD player/PC was connected to the DUT, where the test signals were decoded and finally measured by an audio analyzer at the analog outputs. Since the test files and the measurements ran on different instruments, synchronization was difficult, leading to extended measurement times.

##### Modern solution: Audio Analyzer R&S®UPL plus R&S®UPL-B23

The R&S®UPL-B23 option enables the Audio Analyzer R&S®UPL to generate AC-3 and DTS coded test signals directly with the built-in generator. The measurements are synchronized automatically between the generator and the analyzer.

This has the following advantages:

- ◆ The internal synchronization considerably speeds up measurements
- ◆ Test sequences can be combined much more flexibly, since the number of channels, frequency or level sweep, start and stop frequency/level as well as the number of sweep points can be set directly; settings are made in a similar way to those for a standard analog sweep
- ◆ The test signals are no longer recorded on DVD/PC, thus saving time previously spent on combining and coding the test signals
- ◆ Additional hardware, such as a PC or DVD player, is not required



#### Main features

##### Option R&S®UPL-B23

- ◆ Generation of coded test signals in AC-3 format (Dolby Digital) and DTS format
- ◆ User-selectable sweep parameters

##### Audio Switcher R&S®UPZ

- ◆ Available as input and output switcher
- ◆ Cascading of up to 128 channels
- ◆ Direct operation via the Audio Analyzer R&S®UPL
- ◆ Control via RS-232-C for universal applications

##### Test files available

In addition to the AC-3 format (Dolby Digital), the DTS format is now supported as well; further data formats are in progress. Test files are:

- ◆ Stereo signals (coded with 192 kbit/s) and 5.1-channel signals (448 kbit/s), for frequency and level sweeps; these signals allow the measurement of frequency response, linearity, S/N ratio and harmonic distortion
- ◆ Test signals for the individual channels to determine crosstalk attenuation

**GENERATOR**

<b>INSTRUMENT DIGITAL</b>		
- Src Mode	AUDIO DATA	
- Channel(s)	2 = 1	
- Bal Upp	4.0000 U	
<b>FUNCTION - CODED AUDIO</b>		← Select function
- Format	AC-3	
- Chan Mode	5.1	← Stereo, single channel or multichannel
- SWEEP CTRL	AUTO SWEEP	
- Next Step	ANLR SYNC	← Frequency or level sweep
- X Axis	FREQUENCY	
<b>FREQUENCY</b>		
- Spacing	LOG POINTS	
- Start	20.000 Hz	← Start and stop value
- Stop	20.000 kHz	
- Points	50	← Number of sweep points
- TOTAL VOLT	-20.00 dBFS	

*Sweep generation – as easy as with analog applications*



Contents Overview

Chapter Overview

Type Index

R&amp;S Addresses



## Coded Audio Signal Generation R&S®UPL-B23, Audio Switcher R&S®UPZ

- ◆ Special signals, for example for checking the level settings of the dialog normalization with AC-3 signals

### Measuring surround decoders

Surround applications for use in the home generally have six channels. In order to test 5.1 decoders, the six channels are connected to the Audio Analyzer R&S®UPL via the Audio Switcher R&S®UPZ. The R&S®UPZ is controlled directly from the R&S®UPL panel via an RS-232-C interface.

For professional surround applications, the Audio Switcher R&S®UPZ comprises 8 channels, with two output channels to allow the two R&S®UPL measurement channels to be used simultaneously.

### Input/output model

Like the Audio Analyzer R&S®UPL, the Audio Switcher R&S®UPZ has XLR connectors. Since there is a difference between male and female connectors in the XLR system, the R&S®UPZ is available both as an input and an output model.

It is possible to cascade up to 16 input switchers plus 16 output switchers, allowing up to 128 input and output channels to be switched.

### Extended range of applications

The Audio Switcher R&S®UPZ can be operated not only via the R&S®UPL. Through its RS-232-C interface, it can also be controlled directly from other

units or a controller. This opens up new possibilities; for instance, in broadcasting stations, where studio operations require the switching of several audio channels. The R&S®UPZ may also be used in production; for instance, when car radios are tested, measurements can be performed at all four loudspeaker outputs.



*With the Audio Switcher R&S®UPZ, up to 128 input and 128 output channels can be cascaded*

## Specifications in brief

### Coded Audio Signal Generation R&S®UPL-B23

Format	AC-3 (IEC 61937)	DTS (IEC61937)
Coding		
Stereo signals	192 kbit/s	192 kbit/s
5.1-multichannel	448 kbit/s	754 kbit/s
Single channels	448 kbit/s	754 kbit/s
Frequency range	5.2083 Hz to 20 kHz	5.2083 Hz to 20 kHz
Level range	0 dBFS to -120 dBFS	0 dBFS to -120 dBFS
Sweep parameters	frequency, level	frequency, level
<b>Special signals</b>		
AC-3 dialog normalization	files with 997 Hz tones and -1 dB to -31 dB dialog normalization in 1 dB steps	
AC-3 full-scale value	80 Hz tone on LFE, 997 Hz tones on the other channels; -21 dB to -27 dB dialog normalization	
DTS full-scale value	80 Hz tone on LFE, 997 Hz tones on the other channels	
User-defined	user-defined special signals can be stored	

### Audio Switcher R&S®UPZ

Electrical data	
Signal amplitude <sup>1)</sup>	30 V (RMS)/2 A (42 V (peak))
Crosstalk (balanced 600 Ω load) <sup>2)</sup>	
20 kHz	typ. -140 dB
100 kHz	typ. -126 dB
Series resistance	typ. <0.3 Ω (per signal pin)
Shunt capacitance	typ. <90 pF (each signal pin to ground)

General data	
Operating temperature range	0 °C to +50 °C
Power supply	100 V to 120 V AC (±10%), 220 V to 240 V AC (±10%) 50 Hz to 60 Hz (±5%)
Power consumption	
Input switcher	typ. 5 VA, 10 VA max.
Output switcher	typ. 5 VA, 12 VA typ. (all channels active), 15 VA max.
Remote control	via RS-232-C
Dimensions (W × H × D)	427 mm × 43 mm × 350 mm
Weight	3.7 kg

<sup>1)</sup> For maximum relay life: 5 W or 0.2 A max.

<sup>2)</sup> Between any two channels into 600 Ω.

## Ordering information

Order designation	Type	Order No.
Coded Audio Signal Generation	R&S®UPL-B23	1078.5188.02
Audio Switcher (Input, female)	R&S®UPZ	1120.8004.02
Audio Switcher (Output, male)	R&S®UPZ	1120.8004.03
<b>Accessories supplied for R&amp;S®UPZ</b>		power cable, operating manual, service manual, RS-232-C extension cable
<b>Recommended extras for R&amp;S®UPZ</b>		
19" Rack Adapter	R&S®ZZA-111	1096.3254.00



Contents Overview

Chapter Overview

Type Index

R&amp;S Addresses



## Audio Analyzer R&S®UPV

**Compact instrument for all audio measurements**

**New**

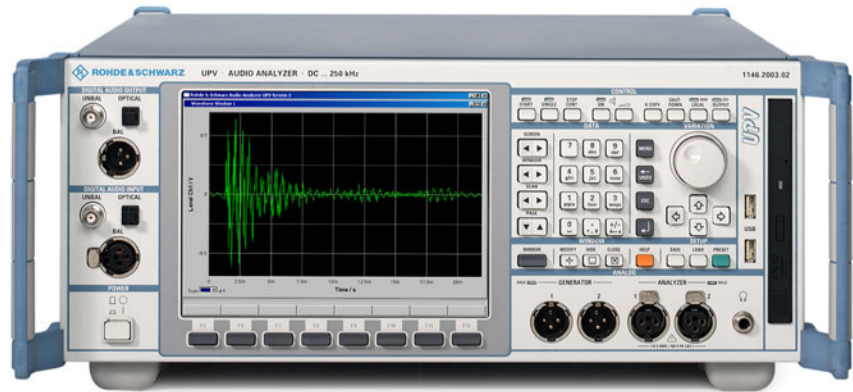

### Brief description

The instrument performs nearly all measurements that occur in the audio world, ranging from frequency response measurements through distortion and spectral display to the analysis of digital interfaces. Several measurement functions can be performed and displayed simultaneously; in contrast to numerous other audio analyzers, all measurements in the audio frequency range are performed as true dual-channel measurements, cutting the measurement time for stereo applications by half.

The generator is just as versatile, creating any conceivable signal from sinewave to noise; these signals can also be output with a user-selectable nominal frequency response.

### Main features

- ◆ Suitable for all interfaces: analog, digital and combined
- ◆ True dual-channel signal processing and generation
- ◆ Recording and replaying of audio signals
- ◆ Maximum dynamic range
- ◆ Sampling rate up to 192 kHz
- ◆ Gapless FFT analysis
- ◆ User-programmable filters for analyzers and generators

- ◆ Jitter analysis and interface tester
- ◆ Compact instrument with integrated PC
- ◆ Extensive online help
- ◆ Slots for future options

### Characteristics

#### Wide scope of test signals

The generators of the R&S®UPV create a wide variety of analog and also digital (option R&S®UPV-B2) test signals:

- ◆ Sinewave signals
- ◆ Intermodulation signals
- ◆ Burst signals
- ◆ Noise
- ◆ DC voltage
- ◆ Dual-channel sinewave signals

#### Diverse measurement functions

The R&S®UPV provides extensive measurement functions on analog and digital (option R&S®UPV-B2) interfaces:

- ◆ Level measurement
- ◆ Selective level measurement
- ◆ SINAD or THD+N measurement
- ◆ Distortion measurement (THD)
- ◆ Modulation factor and DFD
- ◆ DC voltage measurement
- ◆ Frequency, phase and group delay measurement
- ◆ Waveform function
- ◆ FFT analysis

#### All inclusive

The R&S®UPV is an all-in-one instrument with an integrated control PC, making it easy to transport. Since the instrument comes factory-ready, it merely needs to be unpacked and switched on before it can be placed into service. Peripherals are not required, since all essential equipment is included:

- ◆ Hard disk
- ◆ CD/DVD combo drive
- ◆ LAN interface
- ◆ Four USB connectors
- ◆ Connectors for keyboard, mouse, monitor and printer

#### Flexible operation

The R&S®UPV (Windows XP Embedded operating system) is equipped with a modern and intuitive user interface.

The large screen plays a key role, not only for displaying measurement results. All settings are made in panels that contain all functions and settings that are used together.

#### All measurement results at a glance

- ◆ Realtime display of measurement results for one or both channels and multiple measurement functions
- ◆ Scalable graphical windows that can be moved on the screen

## Audio Analyzer R&S®UPV

- ◆ Multiple measurement diagrams simultaneously available (e.g. analyses in the frequency and time domains can be displayed simultaneously)
- ◆ Read-out of graphics with vertical and horizontal cursors as well as superposition and comparison with limit lines or stored measurement results

### Options for expanded applications

#### Low Distortion Generator R&S®UPV-B1

For all applications that require extremely pure analog signals or an extended frequency range up to 200 kHz.

#### Digital Audio I/O 192 kHz R&S®UPV-B2

This option contains the digital audio interfaces (balanced, unbalanced and optical) for the standard sampling rates of 32 kHz to 192 kHz. It can be complemented by the following options:

- ◆ Digital Audio Protocol R&S®UPV-K21 (soon available) for analyzing and generating digital auxiliary data (channel status, user, validity, parity)
- ◆ Jitter and Interface Test R&S®UPV-K22 (soon available) for analyzing the physical parameters of the digital audio interface

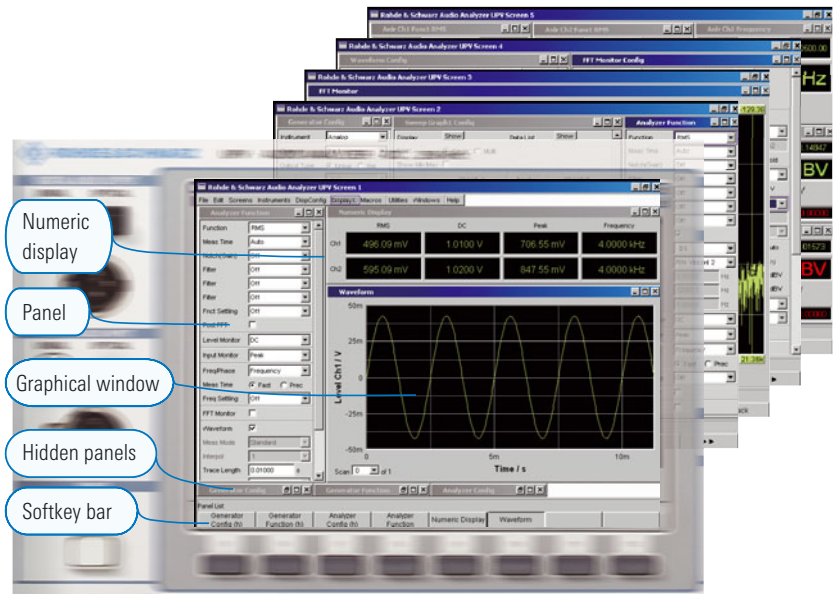

*The large screen provides a straightforward display of all important settings and states of the audio analyzer. Five displays (screens) are available for better arrangement of the large number of possible panels and display windows*

#### Second Analog Generator R&S®UPV-B3

With this second analog output amplifier, different signals can also be output on both analog output channels.

#### I<sup>2</sup>S Interface R&S®UPV-B41 (soon available)

This 2nd digital interface option can be installed in addition to the R&S®UPV-B2, permitting audio analysis on I<sup>2</sup>S chips.

#### Remote Control R&S®UPV-K4

This option ensures remote control operation either via a LAN or an RS-232-C or IEC/IEEE-bus interface in accordance to IEC 625/IEEE488.

#### 150 Ω Modification R&S®UPV-U1

This option changes the source impedance of the analog generator from 200 Ω to 150 Ω.

### Specifications in brief

Analog	
Dual-channel analyzer	up to 250 kHz bandwidth
Generation of sinewave signals	up to 200 kHz, single-channel (R&S®UPV-B1) up to 80 kHz, dual-channel
FFT noise floor	<-140 dB
Inherent frequency response	±0.01 dB (20 Hz to 20 kHz)
Digital	
AES/EBU interface	up to 192 kHz sampling rate
Dynamic range	>170 dB
Functions	
Dual-channel signal generation, dual-channel analysis, analog and digital measurements, FFT analysis up to 256k points	

### Ordering information

Audio Analyzer	R&S®UPV	1146.2003.02
<b>Options</b>		
Low Distortion Generator	R&S®UPV-B1	1146.5202.02
Digital Audio I/O 192 kHz	R&S®UPV-B2	1146.4306.02
Second Analog Generator	R&S®UPV-B3	1146.4806.02
I <sup>2</sup> S Interface	R&S®UPV-B41	1146.5402.02
Digital Audio Protocol	R&S®UPV-K21	1401.7809.02
Jitter and Interface Test	R&S®UPV-K22	1401.7909.02
Remote Control	R&S®UPV-K4	1401.9001.02
150-Ω Modification	R&S®UPV-U1	1146.1507.02
XLR/BNC Adapter Set	R&S®UPL-Z1	1078.3704.02
19" Rack Adapter	R&S®ZZA-411	1096.3283.00



## VOR/ILS Receiver/Analyzer R&S®EVS200

**Monitoring terrestrial  
radionavigation equipment at  
airports and field stations**

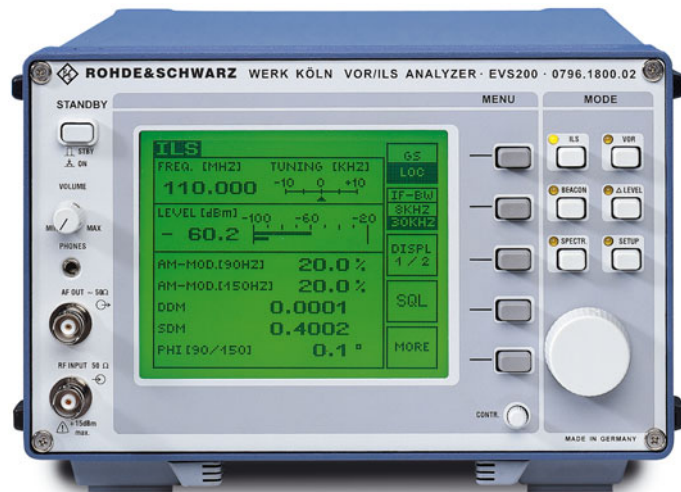

### Brief description

VOR/ILS Analyzer R&S®EVS200 is a portable combinational measuring instrument for monitoring terrestrial radionavigation equipment at airports and field stations. It provides high-precision signal analysis of ILS localizers and glidepath transmitters as well as of VOR systems including marker beacon.

Thanks to its high measurement accuracy and fast data output, R&S®EVS200 is ideal for dynamic, computer-aided measurement of runway characteristics. The wide input level range and optimal shielding of the modules allow measurements to be carried out close to antennas.

### Measurement applications

- ◆ Dynamic runway measurements
- ◆ Measurement of DDM/SDM on antenna array and runway
- ◆ Clearance & glidepath (joint analysis of parameters without switching off transmitter system)
- ◆ Qualification of test signals at field testpoints and checking of bearing indication of VOR/DVOR transmitters
- ◆ Difference level measurement with dynamic range up to 110 dB
- ◆ Measurement of marker beacon signal parameters
- ◆ Point-by-point far-field measurement
- ◆ Measurement of transmitting antenna characteristic using delta level mode
- ◆ Functional monitoring of VOR/ILS transmitter systems in the field including remote data transmission
- ◆ Use in flight inspection systems
- ◆ Further analysis of received signals via multifunctional output (DSP OUT) and audio output
- ◆ Analysis of external audio signals via audio input

### Main features

- ◆ VOR/ILS signal analysis with digital signal processor (DSP)
- ◆ High measurement accuracy and wide dynamic range
- ◆ High long-term stability
- ◆ High measurement speed, 90 measurements/s in ILS mode
- ◆ Minimum susceptibility to interference through special shielding, operational even at high levels up to +15 dBm
- ◆ 120 memory channels for DDM/SDM values
- ◆ Built-in test equipment (BITE)
- ◆ RF spectrum display
- ◆ RS-232-C interface for remote control of all functions and result output
- ◆ Large, illuminated LCD with clear display of results
- ◆ Simultaneous indication of parameters on display
- ◆ AC-supply-independent operation with built-in battery
- ◆ Operation in vehicles from 12 V on-board supply
- ◆ Operation from AC supply voltages 87 V to 265 V at 47 Hz to 63 Hz
- ◆ High mechanical resistance to MIL-810D and DIN IEC 68



Contents Overview

Chapter Overview

Type Index

R&amp;S Addresses



## VOR/ILS Receiver/Analyzer R&amp;S® EVS200

## Specifications

## Receiver section

Frequency	
Range	74.7 MHz to 75.3 MHz, 107 MHz to 119 MHz, 319 MHz to 341 MHz
Deviation	≤2 ppm
Resolution	5 kHz
RF input	
Input voltage	15 dBm max. into 50 Ω
VSWR	<1.5
Sensitivity	−93 dBm ≥16 dB S/N (IF bandwidth 8 kHz)
IF bandwidth	
30 kHz	min. ±15 kHz (−3 dB), max. ±40 kHz (−60 dB)
8 kHz	min. ±4 kHz (−3 dB), max. ±12 kHz (−60 dB)
Demodulation	AM
Absolute level	
Display range	−90 dBm to +10 dBm
Accuracy	≤±2 dB
Difference level	
Bargraph (quasi-analog)	±12 dB (rel. to reference level)
Resolution	0.1 dB
Accuracy	≤±1 dB

## ILS signal analysis

RF level	−70 dBm to −30 dBm
Frequency range	108 MHz to 118 MHz 328 MHz to 336 MHz
Modulation depth (10% to 80%)	
90 Hz/150 Hz ±2%	accuracy 0.5%
300 Hz to 4 kHz (identifier)	≤1.2% of reading
Phase angle 90 Hz/150 Hz	
Measurement range	±60°
Measurement accuracy	≤0.2°
Resolution	0.1°
DDM measurement (≥30 kHz IF bandwidth)	
Localizer mode, measurement accuracy at	
15% to 25% mod. (±0.1 DDM)	≤±0.0004 DDM, ±0.1% of reading
10% to 30% mod. (±0.2 DDM)	≥±0.0004 DDM, ±0.2% of reading
DDM measurement (≥30 kHz IF bandwidth)	
Glideslope mode, measurement	
accuracy at 30% to 50% modulation (±0.2 DDM)	≤±0.0008 DDM, ±0.1% of reading
Resolution (LOC/GS)	0.0001 DDM
Analog DDM output	
Localizer	0 V to 1 V in 4 subranges
Glideslope	0 V to 1 V in 4 subranges
SDM measurement	
SDM 10% to 80%	accuracy ±1% absolute
Resolution	0.0001 SDM

## VOR signal analysis

Azimuth	
Accuracy	±0.1°
Resolution	0.05°/0.01° (setup)
AM modulation depth 30 Hz and 9.96 kHz	
Accuracy	≤1%
Resolution	0.1%
FM deviation	
Accuracy	0.5%, ±0.1 Hz
Resolution	0.1 Hz

## General data

RS-232-C interface	8N1
Selectable baud rate	1200, 2400, 4800, 9600, 19200
Operating temperature range	+5°C to +45°C
Storage temperature range	−20°C to +60°C
Power supply	
AC	87 to 265 V, 47 to 63 Hz (440 Hz optional), built-in battery charger
External DC	9 V to 15 V DC (typ. 12 V DC, 1.4 A)
Battery	12V/3.2 Ah
Charging	during AC-supply operation
Operating time	>90 min with average brightness of display
Mechanical resistance	shock-tested to MIL-810D
Vibration test	to DIN IEC 68-2-36 and 68-2-6
EMC	
RF leakage	to EN55011
RF pickup	to EN61326-1
Dimensions (W × H × D)	219 mm × 147 mm × 350 mm
Weight	6.5 kg

## Ordering information

VOR/ILS Analyzer	R&S® EVS200	0796.1800.02
Options		
Weatherproof case with 2 straps	R&S® EVS200-T	0798.4264.00
Antenna Set	R&S® EVS200-A	3542.6081.00



Contents Overview

Chapter Overview

Type Index

R&amp;S Addresses



## Modulation Analyzer Family R&amp;S® FMA/FMB

**R&S® FMA: 50 kHz to 1360 MHz**

**R&S® FMAB: R&S® FMA with built-in FM stereo decoder**

**R&S® FMAS: R&S® FMA with receiver and FM stereo decoder**

**R&S® FMAV: analysis for air navigation systems**

**R&S® FMB: extended frequency range up to 5.2 GHz**



*Modulation Analyzer R&S® FMAV*

### Brief description

#### Modulation Analyzer R&S® FMA

R&S® FMA combines the functions of several measuring instruments all in one unit. It allows fast and accurate analysis of all parameters of modulated signals. Thanks to its versatility, it can also be used as an RF counter, power meter, voltmeter, psophometer, distortion meter and as an FM stereo decoder. R&S® FMA is suitable for measurements in the field of broadcasting (e.g. on AM and FM transmitters) as well as radiotelephony and in the calibration of signal generators. It can be upgraded for many other measurement tasks.

#### Modulation Analyzer R&S® FMAB

R&S® FMAB has been especially designed for the analysis of FM stereo broadcast signals. Its measurement tasks include comprehensive analysis of VHF transmitters, channel transposers and VHF/baseband converters. The built-in stereo decoder with all its analysis functions can be separately used via the rear-panel input so that measurements on FM receivers and stereo coders are also possible.

#### Selective Modulation Analyzer R&S® FMAS

R&S® FMAS combines the characteristics of a universal modulation analyzer with those of an FM stereo/TV dual-sound receiver:

- ◆ RF/IF selection for 5 MHz to 1000 MHz can be switched on when required
- ◆ Selective audio analyzer

#### Modulation Analyzer R&S® FMAV

R&S® FMAV features the versatile measurement functions of the basic model and special functions for the needs of air-traffic control authorities, airport operators as well as manufacturers of air-navigation airborne and test systems.

It measures with utmost precision all modulation parameters relevant in VOR and ILS air navigation systems. With its extremely low measurement error achieved by means of digital signal processing, R&S® FMAV meets the stringent requirements placed on measuring instruments for ILS systems of category III. Its high accuracy makes R&S® FMAV also ideal for use as a calibrator for VOR and ILS signal generators.

#### Modulation Analyzer R&S® FMB

R&S® FMB enables modulation analysis right into the lower microwave range. Its fields of application are especially in outside broadcasting, radio relay links as well as testing and calibration of microwave generators. The outstanding characteristics of the basic model are fully maintained in the extended frequency range up to 5.2 GHz. The power meter function of R&S® FMB differs from that of R&S® FMA in that it is individually calibrated as a function of frequency and level.

### Main features

- ◆ Fast, automatic frequency adjustment by direct frequency measurement
- ◆ Low-noise synthesizer with high frequency resolution
- ◆ Separate +PK and -PK detectors with extremely short response time
- ◆ True RMS detector
- ◆ Extremely high accuracy
- ◆ High-precision power measurement (typ. error of R&S® FMA <0.5 dB, even smaller for R&S® FMB)

## Modulation Analyzer Family R&S® FMA/FMB

### High measurement speed

- ◆ Two independent frequency counters for simultaneous RF and AF frequency measurements
- ◆ All measurement times can be adapted to the specific measurement problem, e.g. lowest measurement frequency or required counter resolution
- ◆ Measurement functions that are not required can be switched off
- ◆ FM demodulator with high bandwidth for analysis of digital modulators (e.g. mobile radio)

### Additional features of R&S® FMAS

- ◆ Excellent static and dynamic selectivity and high sensitivity for direct measurements at the antenna
- ◆ Excellent transmission quality
- ◆ High overload capability to interfering signals
- ◆ Selective RF level measurement
- ◆ Low distortion due to phase-linear IF filters

### Operation

- ◆ Menu-guided operation with softkeys
- ◆ Nonvolatile storage of up to 20 complete instrument setups
- ◆ Three displays for simultaneous readout of measurement results and indication of all important instrument settings
- ◆ Quasi-analog indication of high resolution with absolute or selective as well as MIN-MAX display
- ◆ IEC/IEEE-bus remote control to IEEE 488.2

## Overview of equipment and options

● Standard    R&S® FMA-Bxx Option    – not available

Functions of individual models, options	R&S® FMA	R&S® FMA-B	R&S® FMAS	R&S® FMAV	R&S® FMB
<b>AM/FM/φM</b>	●	●	●	●	●
<b>Weighting filters (CCITT, ITU-R)</b> lowpass filter 5 Hz, 4.2 kHz (high skirt selectivity), 30 kHz, 120 kHz (Bessel), special φM filter	R&S® FMA-B1	●	●	R&S® FMA-B1	R&S® FMA-B1
<b>DIST/SINAD Meter</b> 10 Hz to 100 kHz, distortion measurable down to typ. <0.005%	R&S® FMA-B2	●	R&S® FMA-B2	R&S® FMA-B2	R&S® FMA-B2
<b>Stereo Decoder:</b> precision instrument, built-in RDS demodulator with external evaluation facility	R&S® FMA-B3	●	●	–	R&S® FMA-B3
<b>AM/FM Calibrator/AF Generator</b> high-precision level calibration, R&S® FMA performance test, complete modulation test set for transmitters and transposers, VOR/ILS baseband signal generation/analysis	R&S® FMA-B4	R&S® FMA-B4	R&S® FMA-B4	–	R&S® FMA-B4
Same as before, but with <b>AF and VOR/ILS generator</b>	–	–	–	R&S® FMA-B4	–
<b>VOR/ILS measurements</b>	–	–	–	●	–
<b>ILS distortion meter</b>	–	–	–	●	–
<b>AF Analyzer/DSP Unit:</b> selective AF analysis up to 45 kHz, digital AF analyzer, true TH measurement, measurement of intermodulation products	–	–	–	●	–
<b>Selective AF analysis up to 150 kHz</b>	R&S® FMA-B8	R&S® FMA-B8	●	–	R&S® FMA-B8
<b>RF/IF Selection:</b> 5 MHz to 1000 MHz, can be switched on when required; tracking 4-section preselection, selectable IF filters	R&S® FMA-B9	R&S® FMA-B9	●	–	–
<b>Reference oscillator</b> ( $1 \times 10^{-7}$ /year)	R&S® FMA-B10	R&S® FMA-B10	R&S® FMA-B10	●	R&S® FMA-B10
<b>5.2 GHz Frequency Extension</b> enhanced power measurement accuracy	R&S® FMA-B12	R&S® FMA-B12	–	–	●



Contents Overview

Chapter Overview

Type Index

R&amp;S Addresses



## Modulation Analyzer Family R&amp;S® FMA/FMB

## Specifications in brief

You will find detailed and binding data on the enclosed CD (../DATASHEET/FMAx.pdf), or, for the latest updates, visit [www.rohde-schwarz.com](http://www.rohde-schwarz.com), search term: FMAx

Frequency	
Frequency range	
R&S® FMA, R&S® FMAB, R&S® FMAV	50 kHz to 1.36 GHz
R&S® FMAS	5 MHz to 1000 (1360) MHz
R&S® FMB as well as R&S® FMA and R&S® FMAB with option R&S® FMA-B12	50 kHz to 5.2 GHz
Frequency tuning	automatic or manual
Display	10-digit readout
Resolution	0.1/1/10/100 Hz selectable
RF power measurement with calibration (R&S® FMA models)	
Power measurement range	0.18 µW to 1 W (–37.5 to +30 dBm)
RF power measurement (R&S® FMB)	
Measurement range	0.18 µW to 1 W (–37.5 to +30 dBm)
Amplitude modulation measurement	
Modulation frequency range	10 Hz to 200 kHz
Frequency modulation measurement	
Modulation frequency range	10 Hz to 200 kHz
Max. measurable deviation for $f_m$	
50 kHz to 300 kHz	$f_m/10$
0.3 MHz to 10 MHz	150 kHz
≥10 MHz	700 kHz
Stereo S/N ratio, weighted	≥76 dB
Stereo crosstalk attenuation	≥56 dB ( $f_{mod}=1$ kHz)
Deemphasis	50/75/750 µs selectable
Phase modulation measurement	
Modulation frequency range	200 Hz to 200 kHz
Max. measurable deviation	
300 kHz to 10 MHz	150 rad
≥10 MHz	700 rad
AF voltmeter	
DC voltage measurement range	±10 µV to 20 V
AC voltage measurement range	30 µV to 20 V
Frequency range	10 Hz to 300 kHz
All AF measuring facilities such as detectors, filters, frequency counter and distortion meter can also be used in voltage measurements for weighting.	
AF detector	
Peak detector	positive or negative peak or their arithmetic mean
RMS detector	readout as RMS value or converted to peak for sine wave
Quasi-peak detector (with R&S® FMA-B1)	detector to ITU-R Rec. 468-4
Weighting filters	
Highpass filters (2nd/3rd/2nd order)	10/20/300 Hz
Lowpass filters	3/23 kHz (4th order), combined with 20 Hz highpass filter meets ITU-R 468-4, unweighted; 100 kHz (4th order)
Filter option R&S® FMA-B1	ITU-R 468-4 (weighted), CCITT P53, 5 Hz lowpass, 30 kHz and 120 kHz Bessel lowpass of 4th order, 4.2 kHz Cauer lowpass, special φM filter
AF frequency display	
Frequency range, resolution	5 digits 10 Hz to 300 kHz, 1 mHz to 10 Hz

**Distortion measurement (option R&S® FMA-B2)**

Readout	in % or SINAD in dB
Automatic adjustment	for S/N ≥20 dB
Measurement range	10 Hz to 100 kHz
Display range THD/SINAD	0.005% to 50%/76 dB to 86 dB
Stereo decoder (option R&S® FMA-B3)	
Crosstalk attenuation	≥60 dB (30 Hz to 15 kHz)
Frequency response	±0.1 dB (30 Hz to 15 kHz)
Nonlinear distortion	≤0.1% (THD, 30 Hz to 15 kHz)
S/N ratio, ITU-R, weighted, unweighted	≥80 dB
Deemphasis	50 µs or 75 µs, selectable
RDS signals available	data, clock, quality signal, TP information, 57 kHz carrier (TTL)
Measurement time	
Fast modulation measurement	≤120 ms
Remote control	
	IEC 625-1/625-2 (IEEE 488.1./2)

**AM/FM Calibrator/AF Generator (option R&S® FMA-B4)**

The data are tested at 23°C (73.4°F) and warranted by design in the range 23°C ±5°C (73.4°F ± 9°F).

<b>AF</b> (single-tone and two-tone signals)	10 Hz to 100 kHz
Resolution, Accuracy	1 mHz, 1 mHz + refer. frequency drift
Level	1 mV to 7 V (max. 10 V ( $V_{pp}$ ))
Frequency response (at $Z_{in} = 20 \Omega$ , $C_L \leq 200$ pF), 10 Hz to 50 kHz	≤±0.1%
THD + N (level ≤6 V), 10 Hz to 20 kHz	≤0.02%
Difference-frequency distortion (two-tone signals, peak voltage ≤8 V)	≥74 dB (10 Hz to 20 kHz)

**Stereo MPX**

Data determined by design, not tested individually. Generation of stereo multiplex signals L, R, R=L, R=–L including 19 kHz pilot tone (disconnectible) or 19 kHz pilot tone + 57 kHz subcarrier (without multiplex signal)

Linear distortion	
Preemphasis	50/75 µs, selectable
Frequency response (10 Hz to 53 kHz)	0.1%
Crosstalk attenuation	≥65 dB (30 Hz to 15 kHz)
Non-linear distortion and difference-frequency distortion	
	≥70 dB
Unweighted and weighted	
S/N ratio to ITU-R 468-4	≥80 dB

**Pilot tone**

Nominal frequency	19 kHz ±1 mHz + refer. frequency drift
Phase versus carrier	≤0.1°
Setting range	±10°

**57-kHz subcarrier (only possible with multiplex signal switched off)**

Nominal frequency	57 kHz ±1 mHz + refer. frequency drift
Phase versus pilot tone	≤0.1°
Setting range	±30°

**VOR/ILS (R&S® FMAV only)**

Data determined by design, not tested individually.

VOR	
Deviation accuracy at 9.96 kHz subcarrier	≤±0.1% ±1 Hz
Setting range	0 Hz to 700 Hz
Phase accuracy 30 Hz	≤±0.005°
ILS	
Frequency response 90 Hz/150 Hz	≤±0.02%
Additional gain difference error	≤0.1% × amplitude difference
Phase accuracy 90 Hz/150 Hz	≤±0.05°



Contents Overview

Chapter Overview

Type Index

R&amp;S Addresses





Contents Overview

Chapter Overview

Type Index

R&S Addresses



## Modulation Analyzer Family R&S® FMA/FMB

AM	
Carrier frequency	10 MHz
Level	-10 dBm
Modulation depth	adjustable from 0% to 99%
Modulation frequency response	≤0.1% (15 Hz to 10 kHz)
Modulation distortion (THD + N, m = 80%)	≤0.1% (10 Hz to 20 kHz)
AM VOR/ILS (R&S® FMAV only)	
ILS	
DDM accuracy m = 18% to 22%	≤±0.00005 DDM ±0.001 × (DDM)
DDM accuracy m = 32% to 48%	≤±0.0001 DDM ±0.001 × (DDM)
Phase accuracy 90 Hz/150 Hz	≤0.1°
VOR	
Deviation accuracy at 9.96 kHz subcarrier	≤±0.1% ±1 Hz
Setting range	0 Hz to 700 Hz
Phase accuracy 30 Hz	≤0.01°
FM	
Carrier frequency	10 MHz
Level	-10 dBm
Deviation (f <sub>mod</sub> = 1 kHz, squarewave)	100 kHz
Additional sinewave modulation	f <sub>mod</sub> = 10 Hz to 100 kHz, dev. = 1 kHz to 100 kHz
Residual FM (BW = 23 kHz, RMS)	≤10 Hz
Modulation frequency response	≤0.5% (10 Hz to 100 kHz)
Modulation distortion for 100 kHz deviation	≤0.1% (f <sub>mod</sub> = 10 Hz to 20 kHz)
Level	
Carrier frequency	10 MHz
Level range	-50 dBm to -4 dBm
Output	BNC female on front panel (CAL), can be internally switched to RF input

### R&S® FMAS receive mode

Instead of the optional DIST/SINAD Meter R&S® FMA-B2, the optional AF Analyzer/DSP Unit R&S® FMA-B8 is fitted in the R&S® FMAS.

### RF/IF Selection (option R&S® FMA-B9)

Frequency	
Frequency range	5 to 1000 MHz
	FM wide      FM narrow/TV 2-sound
IF bandwidth (-3 dB)	350 kHz      150 kHz
Shape factor (-3/-60 dB)	3.4      3.7
RF level	
RF input level range	-87 dBm to +30 dBm (10 μV to 7 V)
Overload protection	up to 5 W (15 V RMS), max. peak voltage 25 V
VSWR	≤2.7 (without attenuation) ≤1.4 (with ≥10 dB attenuation)
Selective level measurement	peak measurement
Measurement accuracy	
5 MHz to 500 MHz	±2 dB ±3 μV
500 MHz to 1000 MHz	±3 dB ±3 μV

### FM stereo

Selectivity						
Ratio of wanted to unwanted signal for a weighted S/N ratio of ≥54 dB, referred to a wanted signal of Δf = 40 kHz, f <sub>mod</sub> = 500 Hz.						
Stereo measurements with 50 μs deemphasis in stereo decoder. Specifications apply to input levels ≥200 μV (-61 dBm) for mono, ≥2 mV (-41 dBm) for stereo.						
Nearby selectivity, unwanted sig. modulated, f <sub>mod</sub> = 500 Hz, Δf = 75 kHz						
	stereo		mono			
	FM wide	FM narrow	FM wide	FM narrow		
Frequency difference						
±100 kHz	≤64 dB	≤61 dB	≤7 dB	≤4 dB		
±200 kHz	≤25 dB	≤11 dB	≤7 dB	≤0 dB		
±300 kHz	≤5 dB	≤-15 dB	≤4 dB	≤-16 dB		
±600 kHz	-	-	≤-26 dB	≤-46 dB		
Far-off selectivity, unwanted signal modulated, f <sub>mod</sub> = 500 Hz, Δf = 75 kHz, Frequency difference ≥1.2 MHz (except for image frequency and 1st IF)						
87.5 to 108 MHz	-	-	≤-54 dB			
rest of range	-	-	≤-40 dB			
Linear distortion						
Amplitude-frequency response, measured at MPX signal output, Δf = 40 kHz, reference frequency 500 Hz						
	FM wide		FM narrow			
40 Hz to 43 kHz	±0.1 dB					
43 kHz to 53 kHz	±0.1 dB		±0.3 dB			
53 kHz to 61 kHz	±0.2 dB		±1 dB			
Stereo crosstalk L↔R, measured via stereo decoder, without deemphasis						
40 Hz to 5 kHz	-50 dB		-37 dB			
5 kHz to 15 kHz	-44 dB		-31 dB			
Nonlinear distortion						
THD measured at MPX signal output (mono)						
	Δf = 75 kHz		Δf = 100 kHz			
FM	wide	narrow	wide	narrow		
40 Hz to 5 kHz	-	≤0.5%	-	≤1%		
40 Hz to 15 kHz	≤0.25%	-	≤0.5%	-		
Measured via stereo decoder						
	stereo		mono			
FM	wide	narrow	wide	narrow		
40 Hz to 5 kHz						
Δf = 75 kHz	≤0.3%	≤0.8%	≤0.25%	≤0.5%		
Δf = 100 kHz	≤0.6%	≤1.6%	≤0.5%	≤1%		
S/N ratio						
To ITU-R 468-4, deemphasis 50 μs, referred to Δf = 40 kHz, f <sub>mod</sub> = 500 Hz S/N ratio (ITU-R 468-4, weighted) LOW NOISE mode						
	stereo		mono			
f <sub>in</sub> /MHz:	5 to 130	130 to 470	470 to 1000	5 to 130	130 to 470	470 to 1000
Input voltage						
≥200 μV	-					
≥2 mV	≥58 dB		≥56 dB	≥76 dB	≥74 dB	
≥20 mV	≥70 dB	≥63 dB	≥60 dB	≥76 dB	≥74 dB	
TV dual sound						
Input signal	TV dual-sound signal, standard B/G, at IF or in bands I, II and IV, V with and without modulated vision carrier					
Nonlinear distortion	Δf = 50 kHz		Δf = 70 kHz			
Distortion						
f <sub>mod</sub> = 30 Hz to 5 kHz	≤0.3%		0.5%			
f <sub>mod</sub> = 5 to 15 kHz	≤0.5%		1%			



Contents Overview

Chapter Overview

Type Index

R&S Addresses





Contents Overview

Chapter Overview

Type Index

R&amp;S Addresses



## Modulation Analyzer Family R&amp;S® FMA/FMB

**S/N ratio**

Quasi-peak measurement to ITU-R468-4, weighted and unweighted; deemphasis 50  $\mu$ s, ref. to wanted signal of  $\Delta f=30$  kHz and  $f_{\text{mod}}=500$  Hz

Input level (selective)	unweighted	weighted
$\geq 200$ $\mu$ V	$\geq 53$ dB	$\geq 53$ dB
$\geq 2$ mV	$\geq 73$ dB	$\geq 73$ dB

Channel crosstalk, referred to  $\Delta f=30$  kHz,  $f_{\text{mod}}=500$  Hz, selective measurements, deemphasis 50  $\mu$ s, other sound carrier modulated with frequencies from 30 Hz to 15 kHz,  $\Delta f=55$  kHz.

Level (selective)  $\geq 5$  mV  $\geq 80$  dB

## AF Analyzer/DSP Unit (R&amp;S® FMA-B8)

**Selective distortion measurement**

Readout	in % or dB
Display range	0.001 % to 20%, -100 dB to -14 dB

**Intermodulation measurement**

Difference frequency distortion $d_2, d_3$ to IEC 268-3	
Readout	in % or dB
Display range	0.001 % to 20%, -100 dB to -14 dB

**Selective modulation and voltage measurement**

using special bandpass filter, in voltmeter, AM, FM and  $\phi$ M mode

Bandwidth (BW <sub>-3dB</sub> ) at center frequency $f_c$	
1 kHz to $\leq 20$ kHz	B <sub>-3 dB</sub> 2.3 Hz
20 kHz to $\leq 150$ kHz	B <sub>-3 dB</sub> 6.8 Hz
10 Hz to $\leq 1$ kHz	B <sub>-3 dB</sub> 68 Hz

Rear-panel outputs

<b>Scale markers</b>	for external oscilloscope
vertical	13 markers, 10 dB/div
horizontal	10 markers, scaling can be called up via the information menu

## R&amp;S® FMAV, VOR/ILS measurement

**VOR/ILS**

Data are valid within the frequency ranges specified ( $f_{\text{in}}$ ). They are typical values for all frequencies  $\geq 10$  MHz.

<b>VOR</b>	$f_{\text{in}} = 10$ MHz; 108 MHz to 120 MHz
Amplitude modulation measurement	accuracy for $m = 10\%$ to 90%:
$f_{\text{mod}} = 30$ Hz/9.96 kHz	$\pm 0.8\%$ of reading
$f_{\text{mod}} = 300$ Hz to 4 kHz	$\pm 1.2\%$ of reading
Frequency modulation measurement	9.96 kHz carrier
Max. measurable deviation	700 Hz
Accuracy ( $f_{\text{mod}} = 30$ Hz $\pm 1\%$ )	$\pm 0.5\% \pm 0.1$ Hz
Phase difference measurement at 30 Hz	
Measurement range	0° to 360°
Measurement accuracy	$\pm 0.03^\circ$
Resolution	$\leq 0.01^\circ$

<b>ILS</b>	$f_{\text{in}} = 10$ MHz; 108 MHz to 120 MHz; 328 MHz to 336 MHz
Amplitude modulation measurement	$m = 10\%$ to 90%
Measurement accuracy	
90/150 Hz $\pm 2\%$	$\pm 0.5\%$ of reading
300 Hz to 4 kHz (identifier)	$\pm 1.2\%$ of reading
<b>DDM measurement</b>	
Measurement range	0 to $\pm 0.2$ DDM
$f_{\text{mod}}$	90/150 Hz $\pm 1\%$
Measurement accuracy	
$m = 18$ to 22%	$\pm 0.0002$ DDM $\pm 0.1\%$ of reading
$m = 32$ to 48%	$\pm 0.0005$ DDM $\pm 0.1\%$ of reading
Resolution	$\leq 0.0001$ DDM
Measurement of phase angle between	90 Hz and 150 Hz signals
Measurement range	$\pm 60^\circ$
Measurement accuracy	$\pm 0.2^\circ$
Resolution	$\leq 0.01^\circ$

## Ordering information

<b>Modulation Analyzer</b>	R&S® FMA	0852.8500.52
	R&S® FMAB	0856.4750.52
	R&S® FMAV	0856.4509.52
	R&S® FMB	0856.5005.52
<b>Selective Modulation Analyzer</b>	R&S® FMAS	0856.6001.52
<b>Options</b>	possible configurations see pages 283	
Filter	R&S® FMA-B1	0855.2002.52
DIST/SINAD Meter	R&S® FMA-B2	0855.0000.52
Stereo Decoder	R&S® FMA-B3	0856.0003.52
AM/FM Calibrator/AF Generator	R&S® FMA-B4	0855.6008.52
AF Analyzer/DSP Unit	R&S® FMA-B8	0855.9007.55
RF/IF Selection 5 to 1000 MHz	R&S® FMA-B9	0856.6501.52
Reference Oscillator	R&S® FMA-B10	0856.3502.52
5.2 GHz Frequency Extension	R&S® FMA-B12	0855.8500.52
<b>Recommended extras</b>		
Service Kit	R&S® FMA-Z1	0856.4009.52
For R&S® FMAV: High-Power Attenuator 20 dB/50 W	R&S® RDL 50	1035.1700.52



Contents Overview

Chapter Overview

Type Index

R&amp;S Addresses





*R&S® SMART SENSOR TECHNOLOGY – ready for a wide variety of applications*

## Contents of Chapter 7

Designation	Frequency range	Type	Description	Page
<b>Power Meter</b>		R&S®NRP	Base unit for power sensors in R&S®SMART SENSOR TECHNOLOGY	290
<b>Power Sensors</b>				
200 pW to 200 mW	10 MHz to 8 GHz	R&S®NRP-Z11	Universal applicable 3-path sensors in R&S®SMART SENSOR TECHNOLOGY Can be used as standalone measuring instruments even without the basic unit	290
	10 MHz to 18 GHz	R&S®NRP-Z21		
	9 kHz to 6 GHz	R&S®NRP-Z91		
2 nW to 2 W	10 MHz to 18 GHz	R&S®NRP-Z22	Same characteristics as R&S®NRP-Z21 but designed for measurement of higher power values	
20 nW to 15 W	10 MHz to 18 GHz	R&S®NRP-Z23		
60 nW to 30 W	10 MHz to 18 GHz	R&S®NRP-Z24		
1 μW to 100 mW	DC to 18 GHz	R&S®NRP-Z51	Thermocouple sensors with USB interface	
	DC to 40 GHz	R&S®NRP-Z55		





Contents Overview

Chapter Overview

Type Index

R&S Addresses



## Contents of Chapter 7

Designation	Frequency range	Type	Description	Page
<b>Terminating Power Meters</b>		R&S®NRVS	Precision power meter with IEC/IEEE-bus interface for use in labs and systems	294
		R&S®NRVD	Versatile precision power meter with IEC/IEEE-bus interface and two channels	296
<b>Power Sensors</b>			For all terminating power meters and RF millivoltmeters (for R&S®URV5: R&S®NRV-Z1 to -Z6 only)	298
100 pW to 20 mW	100 kHz to 40 GHz	R&S®NRV-Z1/-Z3/-Z4/-Z6/-Z15	Highly sensitive diode sensors 50 Ω for power measurement with wide dynamic range	
10 nW to 0.5 W 1 μW to 30 W	100 kHz to 18 GHz DC to 40 GHz	R&S®NRV-Z2/-Z5 R&S®NRV-Z51 to 55	Sensitive diode power sensors Thermocouple sensors for precision power measurements and measurement of average power of modulated signals	
1 μW to 20 mW 100 μW to 2 W 1 mW to 20 W	30 MHz to 6 GHz	R&S®NRV-Z31 R&S®NRV-Z32 R&S®NRV-Z33	Peak power sensors for measuring transmitter power of TDMA mobile radio equipment (GSM 900/1800/1900), TV sync pulse power and for general applications	
<b>Power Reflection Meter</b>		R&S®NRT	Universal power and reflection meter for use in service, installation, labs and systems, AC supply and battery operation; IEC/IEEE bus and RS-232-C interface, simultaneous display of power and reflection	301
<b>Power Sensors</b> 0.7 mW to 120 (300) W 0.3 mW to 2000 W 200 kHz to 1 GHz	200 MHz to 4 GHz	R&S®NRT-Z43, -Z44 R&S®NAP-Z3 to -Z8 R&S®NAP-Z10, -Z11	Power sensors for all common frequency bands and digital networks; measurement of average power and peak envelope power (PEP) of modulated signals (depending on sensor)	301
<b>Power Reflection Meter</b>		R&S®NAS	Low-cost measuring instrument for use in system installation, with analog display of power and SWR, battery operation; handy, easy to operate	305
<b>Power Sensors</b> 10 mW to 1200 W	1 to 1990 MHz	R&S®NAS-Z1/-Z2/-Z3 R&S®NAS-Z5/-Z6/-Z7	Power sensors for all common communication bands, also for GSM 900/1800/1900	306
<b>RF Millivoltmeters, Level Meters</b>		R&S®URV35	Voltage, level and power measurements in service, field service and labs, AC supply and battery operation; high measurement convenience through digital display combined with intelligent moving-coil meter	307
		R&S®URV5 R&S®URV55	RF millivoltmeter with IEC/IEEE-bus interface and two channels RF millivoltmeter with IEC/IEEE-bus interface for use in labs and systems	308 309
<b>Voltage probes</b> 200 mV to 10 V 200 mV to 10 V 2 mV to 100 V	20 kHz to 1 GHz 9 kHz to 3 GHz 100 kHz to 3 GHz	R&S®URV5-Z7 R&S®URV5-Z2 R&S®URV5-Z4	For all RF millivoltmeters/level meters and terminating power meters: Large variety of accessories for measurements on noncoaxial and coaxial lines Insertion units 50 Ω for voltage measurements on coaxial lines with load connected	311
1 mV to 100 V	DC	R&S®URV5-Z1	DC probe for low-load measurements on RF modules	
<b>Broadband Voltmeters</b> 50 μV to 300 V	DC, 0.02 Hz to 30 MHz	R&S®URE3	RMS and peak voltmeter with IEC/IEEE-bus interface for use in labs, production and systems; high measurement speed, low measurement uncertainty, DC and AC coupling, frequency measurement	313
50 μV to 300 V	DC, 10 Hz to 25 MHz	R&S®URE2	Low-cost RMS voltmeter similar to R&S®URE3, but without peak and frequency measurement	313



Contents Overview

Chapter Overview

Type Index

R&S Addresses





Contents Overview

Chapter Overview

Type Index

R&amp;S Addresses



## Power Meter R&S®NRP

With R&S®*SMART SENSOR TECHNOLOGY* – ready for a wide variety of applications



### Brief description

Top measurement accuracy plus a dynamic range up to 90 dB for broadband signals of any modulation are the most important characteristics of the Power Meter R&S®NRP. The versatile sensors in R&S®*SMART SENSOR TECHNOLOGY* are a priceless investment if you wish to meet future requirements such as the broadband modulation types of third-generation mobile radio. In addition, the R&S®NRP is also suitable of handling the RF bandwidths beyond 100 MHz that are already under discussion for wireless LAN.

### Main features

- ◆ Intelligent sensors – simply plug in and measure
- ◆ Innovative multipath sensor technology
- ◆ 90 dB dynamic range
- ◆ High measurement accuracy and speed
- ◆ Multislot measurements for common time division systems (e.g. GSM/EDGE, DECT)
- ◆ Handling of external components through  $\Gamma$  and s-parameter correction

- ◆ Simultaneous operation of up to 4 sensors on basic unit
- ◆ Remote control via IEEE bus and USB
- ◆ Battery operation (optional)
- ◆ Ethernet LAN interface (optional)
- ◆ Operation of sensor directly from PCs via USB interface
- ◆ 2-year calibration cycle

### Universal basic unit

The R&S®NRP is small, lightweight and rugged, and the optional battery pack ensures several hours of operation without line power. Depending on requirements, it can be fitted with one, two or four measurement inputs. The IEEE/IEC-bus connector and USB connector are a standard feature as are the trigger input and the analog measurement output.

The user interface of the power meter takes its cue from the PC world. The high-resolution graphical display can show as many as four measurement results at the same time. The user can choose which results to display – either the data from the sensors (with a maximum of four connected simultaneously) or from different timeslots of a TDMA signal measured by means of one sensor.

### Intelligent sensors

The sensors currently available cover a frequency range from DC to 40 GHz and measure power between 200 pW and 30 W. All sensors are independent instruments remotely controlled via the USB and can be operated from an R&S NRP base unit, various other instruments such as the R&S SMU or the R&S FSP, or from a PC.

### Universal power sensors

These sensors are based on multipath architecture and multiple diode technology. They provide high-accuracy, high-speed measurements of the power parameters most frequently needed, i.e. average power, average burst power, timeslot power, and power-versus-time profile. With a dynamic range up to 90 dB and a frequency range up to 18 GHz, these sensors cover a variety of applications.

### Average power sensors

Based on multipath architecture, these sensors measure the average power of modulated and unmodulated signals over a wide dynamic range with high accuracy.



Contents Overview

Chapter Overview

Type Index

R&amp;S Addresses





Contents Overview

Chapter Overview

Type Index

R&amp;S Addresses



## Power Meter R&S®NRP

### Thermal power sensors

These power sensors provide extremely high accuracy for reference applications in the frequency range up to 40 GHz. They are based on the tried-and-tested thermal sensor technology from Rohde & Schwarz also employed by the R&S NRV family.

### High system accuracy

#### Precise calibration

The accuracy of a microwave power measurement essentially depends on the characteristics of the sensor. The deviation of each manufactured sensor from the ideal characteristic is measured and then the value is stored in the sensor as a data record.

A power sensor can only be as good as the measuring instruments used to calibrate it. This is why the standards employed by Rohde & Schwarz are directly traceable to the power standards of the German Standards Laboratory (PTB).

#### High measurement accuracy – even with modulated signals

The concept of R&S®*SMART SENSOR TECHNOLOGY™* comprises an entire series of measures intended to make the multiple-path diode sensors similar to thermal sensors in behaviour. This includes very accurate measurement of average power, regardless of modulation, as well as high immunity to incorrect weighting of harmonics, spurious and other interference signals.

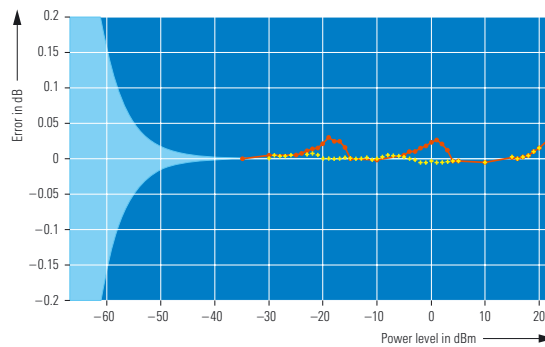

*Modulation-related errors of an R&S®NRP-Z11 or R&S®NRP-Z21 power sensor for a 3GPP test signal (test model 1-64) compared to a CW signal of the same magnitude. Red: default setting; yellow: transition area between measurement paths shifted by -6 dB; light blue: uncertainty caused by noise (modulation effect below -30 dBm negligible)*

#### $\Gamma$ correction

The most important source of error in power measurements on RF and microwave signals is the mismatch of source and sensor. To minimize the influence of mismatched sources, the standing wave ratio (SWR) at the sensor end was reduced to the extent technically feasible. Additionally the complex reflection coefficient of the source can be transmitted to the sensor via the USB data interface, and the sensor can correct the matching error by means of  $\Gamma$  correction, taking into consideration its own low impedance mismatch.

#### S-parameter correction

Especially in production facilities, the sensor is not direct connected with the source but via preceded attenuators or directional couplers. With the help of a software tool, the complete s-parameter data set of the twoport connected ahead

can be loaded into the sensor's memory via the USB data interface. The data format required (s2p/Touchstone) is provided by any vector network analyzer. After the source's complex reflection coefficient has been transmitted (optionally), a perfectly corrected reading is obtained.

#### Use on a PC

The sensors of the R&S®NRP-Z series can be used as standalone measuring instruments even without the basic unit. In addition to the power sensor itself, they include a CPU that controls the sensor, processes the measurement results and operates the interface. All measurement data and settings are transmitted via a digital USB interface. In order to control the R&S®NRP power sensors via a PC several drivers and a user interface (Power Viewer) with basic functionality are available.

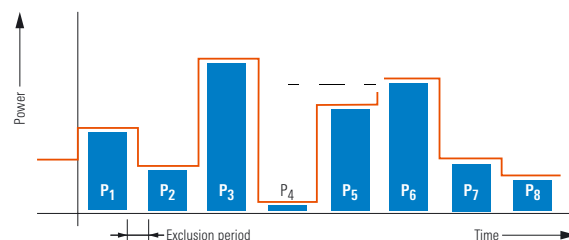

*Multislot measurement: for the most common time division methods (e.g. GSM/EDGE, DECT), average power can be measured in all timeslots at the same time*



Contents Overview

Chapter Overview

Type Index

R&amp;S Addresses



## Power Meter R&S®NRP

### Two adapters are available for connection to the hardware

- ◆ The passive USB Adapter R&S®NRP-Z4 provides all basic functions, as it handles the transmission of settings and measurement data as well as the power supply of the sensor
- ◆ The active USB Adapter R&S®NRP-Z3 has been developed for applications requiring external triggering of the power sensor. It also offers a separate power supply

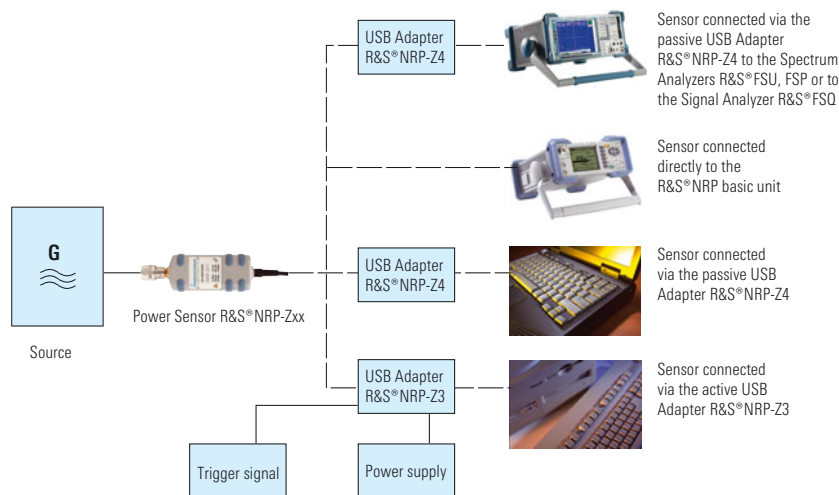

Four possibilities of connecting the R&S®NRP sensors

### Specifications in brief

You will find detailed and binding data on the enclosed CD

(../DATASHEET/NRP.pdf), or, for the latest updates, visit [www.rohde-schwarz.com](http://www.rohde-schwarz.com), search term: NRP

#### Power sensors

Model	Frequency range	Power measurement range, max. power	SWR	Rise time, video bandwidth	Zero offset	Display noise	Linearity in dB (15°C to 35 °C)	Calibration uncertainty in dB
<b>Universal power sensors</b>								
NRP-Z11	10 MHz to 8 GHz	200 pW to 200 mW 400 mW (AVG) 1 W (PK, 10 µs)	10 MHz to 2,4 GHz: <1,13 >2,4 GHz to 8 GHz: <1,20 >8 GHz to 18 GHz: <1,25	<8 µs >50 kHz	64 pW	40 pW	0,022 to 0,097	0,047 to 0,083
NRP-Z21	10 MHz to 18 GHz	2 nW to 2 W 3 W (AVG) 10 W (PK, 10 µs)	10 MHz to 2,4 GHz: <1,14 >2,4 GHz to 8 GHz: <1,20 >8 GHz to 12,4 GHz: <1,25 >12,4 GHz to 18 GHz: <1,30					
NRP-Z22	10 MHz to 18 GHz	20 nW to 15 W 18 W (AVG) 100 W (PK, 10 µs)	10 MHz to 2,4 GHz: <1,14 >2,4 GHz to 8 GHz: <1,25 >8 GHz to 12,4 GHz: <1,30 >12,4 GHz to 18 GHz: <1,41					
NRP-Z23	10 MHz to 18 GHz	60 nW to 30 W 36 W (AVG) 300 W (PK, 10 µs)						
NRP-Z24	10 MHz to 18 GHz							
<b>Average power sensors</b>								
NRP-Z91	9 kHz to 6 GHz	200 pW to 200 mW 400 mW (AVG) 1 W (PK, 10 µs)	9 kHz to 2,4 GHz: <1,13 >2,4 GHz to 6 GHz: <1,20	---	64 pW	40 pW	0,022 to 0,097	0,047 to 0,083
<b>Thermal power sensors</b>								
NRP-Z51	DC to 18 GHz	1 µW to 100 mW 300 mW (AVG) 10 W (PK, 1 µs)	DC to 2,4 GHz: <1,10 >2,4 GHz to 12,4 GHz: <1,15 >12,4 GHz to 18 GHz: <1,20 >18 GHz to 26,5 GHz: <1,25 >26,5 GHz to 40 GHz: <1,30	---	33 nW	20 nW	0,020	0,047 to 0,098
NRP-Z55	DC to 40 GHz							0,053 to 0,112



Contents Overview

Chapter Overview

Type Index

R&amp;S Addresses



## Power Meter R&amp;S®NRP

## Other power sensor characteristics

## Measurement functions

Continuous average	continuous measurement of average power; duration of measurement window can be selected
Burst average (NRP-Z1x/-Z2x only)	measurement of average burst power with automatic burst detection
Timeslot/gate (NRP-Z1x/-Z2x only)	measurement of average burst power in one or more timeslots
Scope (NRP-Z1x/-Z2x only)	measurement of power versus time

## Averaging filter

Average factor	1...2 <sup>16</sup>
Automatic modes	Normal (filter setting depends on power to be measured and on resolution) Fixed Noise (filter set to specified noise content)

## Correction functions

Frequency	calibration factors relevant for test frequency are taken into account
Attenuation	measurement result is corrected by means of fixed factor (dB offset)
S-parameter	component connected ahead of sensor is taken into account by loading its S parameter data set into sensor
Gamma	influence of mismatched sources is reduced

## Triggering

Source	Internal, External, Bus, Immediate, Hold
Slope	pos./neg.
Level (internal)	-40 dBm to +23 dBm (NRP-Z11, -Z21) -30 dBm to +33 dBm (NRP-Z22) -19 dBm to +42 dBm (NRP-Z23) -14 dBm to +45 dBm (NRP-Z24)

## Sensor interface to host

Power supply	+5 V/200 mA typ. (USB high-power device)
Remote control	as a USB device (function) in full-speed mode, compatible with USB 1.0/1.1/2.0 specifications
Trigger input	differential (0/+3.3 V)
<b>Dimensions</b> (W × H × L)	length incl. connecting cable: ~1.6 m
R&S®NRP-Z11/21/51/55/91	48 mm × 31 mm × 170 mm
R&S®NRP-Z22	48 mm × 31 mm × 214 mm
R&S®NRP-Z23	60 mm × 54 mm × 285 mm
R&S®NRP-Z24	60 mm × 54 mm × 344 mm
<b>Weight</b>	<0.3 kg

## Manual operation

Windows-oriented menus with hotkeys for the most important functions

## Remote control

IEC/IEEE 488 bus, USBTMC, Ethernet/VXI11

## Power supply

220 V to 240 V (±10%), 50 Hz to 60 Hz (±10%)  
100 V to 120 V (±10%), 50 Hz to 400 Hz (±10%)  
Apparent power <80 VA

## Dimensions (W × H × D)

274 mm × 112 mm × 267 mm

## Weight

&lt;3.0 kg

## R&amp;S NRP basic unit

Measurement channels 1 to 4

## Measurement functionality single-channel

See sensor specifications, plus:

relative measurement referenced to result or user-selectable reference value, storage of minima and maxima (Max, Min, Max-Min), limit monitoring

Display, absolute	in W, dBm and dBμV
Display, relative	in dB, as change in percent (Δ%) or as quotient

## Measurement functionality multichannel

Simultaneous measurement in up to 4 channels; ratio, relative ratio or difference of results of 2 channels can be displayed (for all functions except Scope)

Display	
Difference	in W
Ratio	in dB, as change in percent (Δ%), as quotient or as one of the following matching parameters: SWR, return loss, reflection coefficient
Relative ratio	in dB, as change in percent (Δ%) or as quotient

**Display** LC graphics screen ¼ VGA (320 x 240) pixel, monochrome, transfective**Backlighting** brightness adjustable**Measurement results** up to 4 results with additional information (Min, Max, Max-Min, frequency) can simultaneously be displayed in separate windows

<b>Representation</b>	digital, digital and analog
<b>Resolution</b>	
Digital values	selectable in 4 steps: 0.001 dB to 1 dB
Analog display	depending on user-definable scale end values

## Ordering information

<b>Power Meter</b>	R&S®NRP	1143.8500.02
--------------------	---------	--------------

## Power Sensors

200 pW to 200 mW, 10 MHz to 8 GHz	R&S®NRP-Z11	1138.3004.02
200 pW to 200 mW, 10 MHz to 18 GHz	R&S®NRP-Z21	1137.6000.02
200 pW to 200 mW, 9 kHz to 6 GHz	R&S®NRP-Z91	1168.8004.02
2 nW to 2 W, 10 MHz to 18 GHz	R&S®NRP-Z22	1137.7506.02
20 nW to 15 W, 10 MHz to 18 GHz	R&S®NRP-Z23	1137.8002.02
60 nW to 30 W, 10 MHz to 18 GHz	R&S®NRP-Z24	1137.8502.02
1 μW to 100 mW, DC to 18 GHz	R&S®NRP-Z51	1138.0005.02
1 μW to 100 mW, DC to 40 GHz	R&S®NRP-Z55	1138.2008.02

## Options

Sensor Check Source	R&S®NRP-B1	1146.9008.02
Second Sensor Input (B)	R&S®NRP-B2	1146.8801.02
Battery Supply	R&S®NRP-B3	1146.8501.02
LAN Interface 10/100 Base T	R&S®NRP-B4	1146.9308.02
3rd and 4th Sensor Inputs (C, D)	R&S®NRP-B5	1146.9608.02
Rear-Panel Sensor Inputs A and B <sup>1)</sup>	R&S®NRP-B6	1146.9908.02

## Extras

Sensor Extension Cable to 5 m	R&S®NRP-Z2	1146.6750.05
Sensor Extension Cable to 10 m	R&S®NRP-Z2	1146.6750.10
USB Adapter (active)	R&S®NRP-Z3	1146.7005.02
USB Adapter (passive)	R&S®NRP-Z4	1146.8001.02
19" Rack Adapter (for 1 R&S®NRP + empty case)	R&S®ZZA-T26	1109.4387.00
19" Rack Adapter (for 2 NRPs)	R&S®ZZA-T27	1109.4393.00

<sup>1)</sup> Not in conjunction with the R&S®NRP-B5.

Contents Overview

Chapter Overview

Type Index

R&amp;S Addresses





Contents Overview

Chapter Overview

Type Index

R&amp;S Addresses



## Power Meter R&S®NRVS

DC to 40 GHz

100 pW to 30 W

Power (average, pulse, PEP), level  
and DC voltage measurements



### Brief description

Power Meter R&S®NRVS is an ideal instrument for a great variety of power measurement applications in labs and systems. Thanks to its intelligent sensors with calibration data memory and thermocouple sensors, which make adjustments by the user superfluous, R&S®NRVS provides at all times high-precision measurements free of operator's errors.

### Main features

- ◆ Fast power, level and voltage measurements
- ◆ Intelligent R&S®NRV-Z probes and R&S®URV5-Z sensors: plug and play
- ◆ IEC/IEEE-bus interface
- ◆ DC frequency input for tracking frequency-response correction
- ◆ Analog output
- ◆ Storage of 20 complete instrument setups
- ◆ 13 digital filters for noise suppression, automatic or manual filter selection
- ◆ Sensor check source (optional)

### Characteristics

#### Display

Measurement results, units and various items of information are displayed on a large easy-to-read 4½-digit LC display in three selectable steps of resolution.

#### Pulse power

If pulse-modulated RF signals are measured, R&S®NRVS calculates the pulse peak power from the measured average power and the entered pulse duty factor, and reads out the result directly. The use of Peak Power Sensors R&S®NRV-Z31 and -Z33 for measuring the peak envelope power (PEP) is highly recommended.

#### Measurement rate

The attainable measurement rate not only depends on the type of sensor used but also on the setting of the averaging filter. R&S®NRVS automatically makes the appropriate settings by determining the optimum averaging time required for a steady readout as a function of level and selected resolution. This automatic selection can be switched off.

### Measuring heads

The range of measuring heads includes thermocouple power sensors as well as highly sensitive diode power sensors, peak power sensors (from page 298), probes and insertion units for voltage measurement (from page 311). R&S®NRVS therefore covers a frequency range from DC to 40 GHz and a power span from 100 pW to 30 W.

The power sensors are not specifically designed for R&S®NRVS and can therefore be freely used with any of the Rohde & Schwarz power meters and voltmeters.



Contents Overview

Chapter Overview

Type Index

R&amp;S Addresses





Contents Overview

Chapter Overview

Type Index

R&amp;S Addresses



## Power Meter R&amp;S®NRVS

Specifications in brief,  
power sensors page 298, voltage probes page 311

You will find detailed and binding data on the enclosed CD  
(../DATASHEET/NRVS.pdf), or, for the latest updates, visit  
[www.rohde-schwarz.com](http://www.rohde-schwarz.com), search term: NRVS

<b>Measurement functions</b>	average power, pulse power, peak envelope power, AM, reflection, DC voltage (depending on sensor)
<b>Frequency and level range</b>	DC to 40 GHz, 100 pW to 30 W 9 kHz to 3 GHz, 200 mV to 1000 V (depending on sensor)
<b>Probes and sensors</b>	all R&S®NRV sensors and URV5 probes
<b>Display</b>	LCD for digits, units, menu-guided operation and analog display, adjustable backlighting
Display of results	single-channel (with optional display of correction frequency) or dualchannel
Absolute readout	W, dBm, V, dBmV,
Relative readout	dB, %W or %V relative to a stored reference value
Analog display	automatic or with selectable scale
Digital display and resolution	max. 4½ digits, resolution selectable (0.1/0.01/0.001 dB)
Display filtering	averaging over 1 to 512 readings to reduce display noise; manual or automatic setting depending on measurement range and resolution
Display noise	see sensors from page 311/298
Measurement rate	see table on page 300
<b>Accuracy (without sensors)</b>	
18°C to 28°C	0.4% +1 digit
10°C to 40°C	0.9% +1 digit
0°C to 50°C	1.4% +1 digit
<b>Zero adjustment</b>	manual or via IEC/IEEE bus, duration approx. 4 s
<b>Frequency response</b>	sensor-specific calibration data taken into account; numerical entry of test frequency (keyboard or via IEC/IEEE bus) or by frequency-proportional DC voltage
<b>correction</b>	
<b>Attenuation compensation</b>	external attenuation or gain taken into account; data entry via keyboard or IEC/IEEE bus, range ±200 dB

<b>Entry of reference value</b>	measured value on keystroke or numerical entry via keypad or IEC/IEEE bus
<b>Reference impedance</b>	for conversion between voltage and power, automatic readout of reference impedance from sensor data memory or numerical entry via keyboard or IEC/IEEE bus (for RF probe)
<b>Remote control</b>	IEC 625 (IEEE 488), control of all instrument functions
Interface functions	SH1, AH1, T6, L4, SR1, RL1, DC1, DT1, PPO
<b>DC frequency input</b>	
Connector	BNC
Input voltage range	±12 V, linear with selectable scale
<b>DC output</b>	
Connector	BNC, $R_{out} = 1 \text{ k}\Omega$ , EMF proportional to analog display
Left-/right-hand full-scale value	corresponding to 0/+3 V
Accuracy	±5 mV
Channels	1, 2
<b>Sensor check source</b>	option R&S®NRVS-B1
Output power	1 mW ±0.7%
Frequency	50 MHz
VSWR	1.05
RF connector	N female
<b>General data</b>	
Power supply	115 V +15/–22%, 47 Hz to 63 (440) Hz; 230 V +15/–22%, 47 Hz to 63 Hz, 13 VA
Dimensions (W × H × D)	219 mm × 103 mm × 350 mm
Weight	3.2 kg

## Ordering information

<b>Power Meter</b>	R&S®NRVS	1020.1809.02
<b>Options</b>		
Sensor Check Source	R&S®NRVS-B1	1029.2908.02
<b>Recommended extras</b>		
Rack adapter	R&S®ZZA-97	0827.4527.00
Transit case	R&S®UZ-24	1029.3379.02
Service Kit	R&S®NRVS-S1	1029.2708.02



Contents Overview

Chapter Overview

Type Index

R&amp;S Addresses





Contents Overview

Chapter Overview

Type Index

R&amp;S Addresses



## Dual-Channel Power Meter R&amp;S®NRVD

DC to 40 GHz

100 pW to 30 W

Power, level and voltage

measurements; attenuation and

reflection measurements:

precise, versatile, convenient

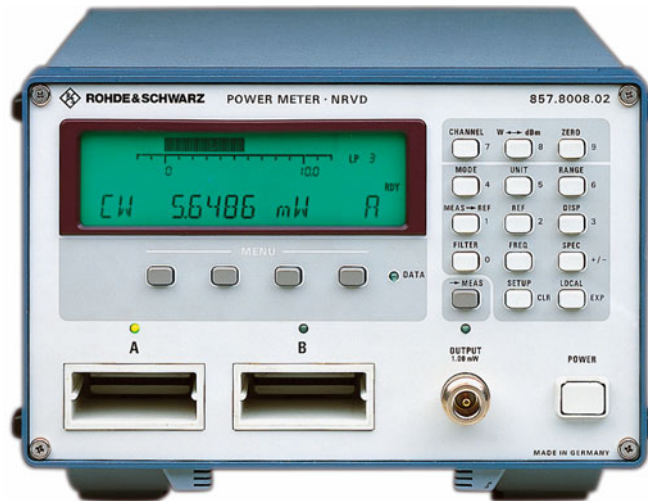

## Brief description

R&S®NRVD functions like two independent R&S®NRVS power meters in one enclosure performing simultaneous measurements and exchanging data with each other. The two channels can be set separately so that two completely different measurements can be carried out at the same time. The two measured values can also be related to each other for read-out of reflection coefficient, SWR or return loss, for instance.

## Main features

- ◆ Two independent channels performing simultaneous measurements
- ◆ LC display with variable backlighting
- ◆ IEC/IEEE-bus interface (optionally SCPI or compatible with URV5)
- ◆ 13 digital filters for noise suppression, automatic or manual filter selection
- ◆ Considering frequency response of external components (attenuators or direction couplers inserted before sensor)

- ◆ Storage of 20 complete instrument setups
- ◆ Input/output option with DC frequency input, analog outputs, trigger input, ready output
- ◆ Large variety of intelligent sensors: plug and play
- ◆ Rear connectors for sensors
- ◆ Sensor check source

## Characteristics

## Display

Measurement results are displayed with selectable resolution on a five-digit LCD with adjustable backlighting. The values measured in the two channels or one measured value plus an additional item of information are displayed.

The R&S®NRVD measures pulse-modulated RF signals like the R&S®NRVS. Additionally, the modulation depth of amplitude-modulated signals can be determined from the power variation. After entering the source matching, the expected uncertainty for thermocouple power sensors can be displayed.

## Measurement rate

See Power Sensors R&S®NRV-Zx, page 300.

## Sensor check source

It supplies a highly accurate, low-distortion 50 MHz signal of 1 mW (0 dBm) power for checking the sensors.

## Input/Output Option R&amp;S®NRVD-B2

Each measurement channel has an analog output with selectable scaling for connection of a recorder or for control purposes. Simple automatic test routines can be implemented with the aid of the trigger input and the ready output. Another input serves for taking up the frequency-proportional DC voltage from a sweep generator for tracking frequency-response correction.



Contents Overview

Chapter Overview

Type Index

R&amp;S Addresses







Contents Overview

Chapter Overview

Type Index

R&amp;S Addresses



## Dual-Channel Power Meter R&amp;S®NRVD

Specifications in brief,  
power sensors page 298, voltage probes page 311

You will find detailed and binding data on the enclosed CD  
(../DATASHEET/NRVD.pdf), or, for the latest updates, visit  
[www.rohde-schwarz.com](http://www.rohde-schwarz.com), search term: NRVD

<b>Measurement functions</b>	average power, pulse power, peak envelope power, AM, reflection, DC voltage (depending on sensor)
<b>Frequency and level range</b>	DC to 40 GHz, 100 pW to 30 W 9 kHz to 3 GHz, 200 mV to 1000 V (depending on sensor)
<b>Probes and sensors</b>	all R&S®NRV sensors and R&S®URV5 probes
<b>Display</b>	LCD for digits, units, menu-guided operation and analog display, adjustable backlighting
Display of results	single-channel (with optional display of correction frequency) or dualchannel
Absolute readout	W, dBm, V, dBmV, dBV
Relative readout R&S®NRVD	dB, difference, percent and ratio, relative to a stored reference value or to the second measurement channel; VSWR, reflection coefficient, return loss in dB, AM modulation depth
Analog display	automatic or with selectable scale
Digital display and resolution	max. 4½ digits, resolution selectable (0.1/0.01/0.001 dB)
Display filtering	averaging over 1 to 512 readings to reduce display noise; manual or automatic setting depending on measurement range and resolution
Display noise	see sensors from page 311/298
<b>Measurement rate</b>	see table on page 300
<b>Accuracy (without sensors)</b>	
18°C to 28°C	0.3% +1 digit
10°C to 40°C	0.8% +1 digit
0°C to 50°C	1.3% +1 digit
<b>Zero adjustment</b>	manual or via IEC/IEEE bus, duration approx. 4 s
<b>Frequency response correction</b>	sensor-specific calibration data taken into account; numerical entry of test frequency (keyboard or via IEC/IEEE bus) or by frequency-proportional DC voltage
<b>Attenuation compensation</b>	external attenuation or gain taken into account; data entry via keyboard or IEC/IEEE bus, range ±200 dB

<b>Entry of reference value</b>	measured value on keystroke or numerical entry via keypad or IEC/IEEE bus
<b>Reference impedance</b>	for conversion between voltage and power, automatic readout of reference impedance from sensor data memory or numerical entry via keyboard or IEC/IEEE bus (for RF probe)
<b>Remote control</b>	IEC625 (IEEE488), SCPI, control of all instrument functions
Interface functions	SH1, AH1, T6, L4, SR1, RL1, DC1, DT1, PP0, PP1
<b>Input/Output Option R&amp;S®NRVD-B2</b>	2 simultaneous DC voltage outputs, DC frequency input, trigger input (TTL, active low), ready output (TTL, active high)
DC frequency input, connector	BNC
Input voltage range	±12 V, linear with selectable scale
DC output, connector	BNC, $R_{out} = 1\text{ k}\Omega$ , EMF proportional to analog display
Left-/right-hand full-scale value	corresponding to 0/+3 V
Accuracy	±5 mV
Channels	1, 2
<b>Sensor check source</b>	
Output power	1 mW ±0.7%
Frequency	50 MHz
VSWR	≤1.03
RF connector	N female
<b>General data</b>	
Power supply	100/120/220 V ±10%, 230 V –6/+15%;
47 Hz to 400 Hz (25 VA)	
Dimensions (W × H × D)	219 mm × 147 mm × 350 mm
Weight	4.5 kg

## Ordering information

<b>Dual-Channel Power Meter</b>	R&S®NRVD	0857.8008.02
<b>Option</b>		
Input/Output Option	R&S®NRVD-B2	0857.8908.02
<b>Recommended extras</b>		
Rack adapter	R&S®ZZA-98	827.4533.00
Service Kit	R&S®NRVD-S1	1029.2808.02



Contents Overview

Chapter Overview

Type Index

R&amp;S Addresses





Contents Overview

Chapter Overview

Type Index

R&S Addresses



## Power Sensors R&S®NRV-Z

### Brief description

For all power measurements with instruments from the R&S®URV/R&S®NRV families, 15 power sensors in all cover the frequency range from DC to 40 GHz. Three classes of sensitivity allow direct measurement of any power between 100 pW and 30 W. A 75-Ω sensor is available for TV and video applications.

The calibration data memory integrated in the sensor contains all the relevant information. With the sensor plugged in, a fully calibrated meter is ready for measurements. The calibration of all sensors can be traced to the relevant standards of the Federal German Bureau of Standards.

For calculating the total measurement uncertainty of the source power delivered to Z<sub>0</sub> load the following factors have to be taken into account: mismatch uncertainty, calibration uncertainty, linearity error, meter noise, zero offset, temperature effect, pulse measurement uncertainty (peak power sensors only) and measurement uncertainty of basic unit.



*Calibration data for each sensor are stored in an EPROM in the sensor's connector*

### Overview of models

#### High-Sensitivity Sensors R&S®NRV-Z1/-Z3/-Z4/-Z6/-Z15

These sensors measure the true RMS power from about 100 pW to 10 μW and can be used in this level range for signals with harmonic contents, noisy or modulated signals. For sinewave signals, the measurement range extends to 20 mW (13 mW into 75 Ω).

#### Medium-Sensitivity Sensors R&S®NRV-Z2/-Z5

Based on diode detectors with 20 dB attenuator, these sensors provide true RMS power measurement in the range

from 10 nW to 1 mW and up to 500 mW for sinewave signals. Compared to thermocouple sensors, shorter measurement times can be attained with these sensors.

#### Thermocouple Power Sensors R&S®NRV-Z51 to -Z55

They measure the average power irrespective of the waveform and therefore are also suitable for spread spectrum, IS-95 CDMA and WCDMA measurements, irrespective of the peak-to-average power ratio of the waveform concerned. Being individually calibrated, these sensors feature an unrivalled linearity over the entire dynamic range.

#### Peak Power Sensors R&S®NRV-Z31 to -Z33

These sensors measure the peak envelope power (PEP) of modulated or pulsed signals. The TDMA models 04 of the sensors allow fast and precise measurement of the transmitter power of mobile stations in GSM 900/1800/1900 networks. Models 03 are suitable for measuring the sync pulse power of TV transmitters. Model .02 with a minimum pulse repetition frequency of 10 Hz is designed for general applications. Model .05 of R&S®NRV-Z32 enables measurement of the power peak value of mobile stations to NADC and PDC standard.

### Specifications in brief

Model	Frequency range	Power range, max. power	Max. SWR (reflection coefficient)	Zero offset (±)	Meter noise	Linearity uncertainty in dB	Calibration uncertainty in dB
R&S®NRV-Z1 N; 50 Ω	10 MHz to 18 GHz	200 pW to 20 mW	0.01 to 1 GHz: 1.06 (0.03)	100 pW	40 pW	0.03	0.07
		100 mW (AVG)	>1 to 2 GHz: 1.13 (0.06)				0.07
		100 mW (PK)	>2 to 4 GHz: 1.27 (0.12)				0.08
R&S®NRV-Z2 N; 50 Ω	10 MHz to 18 GHz	20 nW to 500 mW	0.01 to 4 GHz: 1.05 (0.024)	10 nW	4 nW	0.03	0.07
		2 W (AVG)	>4 to 8 GHz: 1.1 (0.048)				0.07
		10 W (PK)	>8 to 12.4 GHz: 1.15 (0.07)				0.07
			>12.4 to 18 GHz: 1.2 (0.09)				0.09 to 0.13



Contents Overview

Chapter Overview

Type Index

R&S Addresses





Contents Overview

Chapter Overview

Type Index

R&S Addresses



## Power Sensors R&S®NRV-Z

### Specifications in brief

Model	Frequency range Min. pulse width Min. PRF	Power range, max. power	Max. SWR (reflection coefficient)	Zero offset (±)	Meter noise	Linearity uncertainty in dB	Calibration uncertainty in dB
R&S®NRV-Z3 N; 75 Ω	1 MHz to 2.5 GHz	100 pW to 13 mW 70 mW (AVG) 70 mW (PK)	1 to 100 MHz: 1.11 (0.05) >0.1 to 1 GHz: 1.11 (0.05) >1 to 2.5 GHz: 1.2 (0.09)	40 pW	16 pW	0.03	0.06 0.07 0.07
R&S®NRV-Z4 N; 50 Ω	100 kHz to 6 GHz	100 pW to 20 mW 100 mW (AVG) 100 mW (PK)	0.1 to 100 MHz: 1.05 (0.024) >0.1 to 2 GHz: 1.1 (0.048) >2 to 4 GHz: 1.2 (0.09) >4 to 6 GHz: 1.35 (0.15)	50 pW	20 pW	0.03	0.05 to 0.06 0.06 0.06 0.07
R&S®NRV-Z5 N; 50 Ω	100 kHz to 6 GHz	10 nW to 500 mW 2 W (AVG), 10 W (PK)	100 kHz to 4 GHz: 1.05 (0.024) >4 to 6 GHz: 1.1 (0.048)	5 nW	2 nW	0.03	0.05 to 0.06 1.7 to 1.9
R&S®NRV-Z6 PC 3.5; 50 Ω	50 MHz to 26.5 GHz	400 pW to 20 mW 100 mW (AVG) 100 mW (PK)	50 MHz to 4 GHz: 1.15 (0.7) >4 to 18 GHz: 1.37 (0.157) >18 to 26.5 GHz: 1.37 to 0.157)	200 pW	80 pW	0.04	0.06 0.07 to 0.15 0.08 to 0.09
R&S®NRV-Z15 K; 50 Ω	50 MHz to 40 GHz	400 pW to 20 mW 100 mW (AVG) 100 mW (PK)	50 MHz to 4 GHz: 1.15 (0.7) >4 to 18 GHz: 1.37 (0.157) >18 to 40 GHz: 1.37 to 0.157)	200 pW	80 pW	0.04	0.05 to 0.06 0.07 to 0.15 0.08 to 0.1
R&S®NRV-Z31 N; 50 Ω	30 MHz to 6 GHz 2 μs (mod. 02/03), 200 μs (mod. 04) 10 Hz (mod. 02) 100 Hz (mod. 03/04)	1 μW to 20 mW 100 mW (AVG) 100 mW (PK)	0.03 to 0.1 GHz: 1.05 (0.024) >0.1 to 2 GHz: 1.1 (0.048) >2 to 4 GHz: 1.2 (0.09) >4 to 6 GHz: 1.35 (0.15)	30 nW	3 nW	included in calibration uncertainty	0.06 0.07 0.11 to 0.15 0.12 to 0.16
R&S®NRV-Z32 N; 50 Ω	30 MHz to 6 GHz 2 μs (mod. 05), 200 μs (mod. 04) 25 Hz (mod. 05) 100 Hz (mod. 04)	100 μW to 2 W 1 W (AVG) 8 W (PK, 1 μs)	0.03 to 2 GHz: 1.11 (0.052) >2 to 4 GHz: 1.11 (0.052) >4 to 6 GHz: 1.22 (0.099)	3 μW	0.3 μW	included in calibration uncertainty	0.08 to 0.10 0.13 to 0.25 0.18 to 0.27
R&S®NRV-Z33 N; 50 Ω	30 MHz to 6 GHz 2 μs (mod. 03), 200 μs (mod. 04) 100 Hz (mod. 03/04)	1 mW to 20 W 12 W to 18 W (AVG) 80 W (PK)	0.03 to 2 GHz: 1.11 (0.052) >2 to 4 GHz: 1.22 (0.099) >4 to 6 GHz: 1.22 (0.099)	30 μW	3 μW	included in calibration uncertainty	0.08 to 0.10 0.15 to 0.18 0.18 to 0.20
R&S®NRV-Z51 N; 50 Ω	DC to 18 GHz	1 μW to 100 mW 300 mW (AVG) 10 W (PK, 1 μs)	DC to 2 GHz: 1.1 (0.048) >2 to 12.4 GHz: 1.15 (0.07) >12.4 to 18 GHz: 1.2 (0.09)	60 nW	22 nW	0.02	0.05 0.05 to 0.07 0.09 to 0.12
R&S®NRV-Z52 PC 3.5; 50 Ω	DC to 26.5 GHz	1 μW to 100 mW 300 mW (AVG) 10 W (PK, 1 μs)	DC to 2 GHz: 1.1 (0.048) >2 to 12.4 GHz: 1.15 (0.07) >12.4 to 18 GHz: 1.2 (0.09) >18 to 26.5 GHz: 1.25 (0.11)	60 nW	22 nW	0.02	0.05 to 0.06 0.06 to 0.08 0.10 to 0.13 0.08 to 0.09
R&S®NRV-Z53 N; 50 Ω	DC to 18 GHz	100 μW to 10 W 12 W to 18 W (AVG) 1 kW (PK, 1 μs)	0.05 to 2 GHz: 1.11 (0.052) >2 to 8 GHz: 1.22 (0.099) >8 to 12.4 GHz: 1.27 (0.119) >12.4 to 18 GHz: 1.37 (0.157)	6 μW	2.2 μW	0.03 + 0.01 P/W	0.07 0.10 0.12 to 0.13 0.14 to 0.18
R&S®NRV-Z54 N; 50 Ω	DC to 18 GHz	300 μW to 30 W 24 W to 36 W (AVG) 1 kW (PK, 3 μs)	0.05 to 2 GHz: 1.11 (0.052) >2 to 8 GHz: 1.22 (0.099) >8 to 12.4 GHz: 1.27 (0.119) >12.4 to 18 GHz: 1.37 (0.157)	20 μW	7 μW	0.03 + 0.007 P/W	0.08 0.10 to 0.11 0.12 to 0.13 0.14 to 0.18
R&S®NRV-Z55 K; 50 Ω	DC to 40 GHz	1 μW to 100 mW 300 mW (AVG) 10 W (PK, 1 μs)	DC to 2 GHz: 1.1 (0.048) >2 to 12.4 GHz: 1.15 (0.07) >12.4 to 18 GHz: 1.2 (0.08) >18 to 26.5 GHz: 1.25 (0.11) >26.5 to 40 GHz: 1.30 (0.13)	60 nW	22 nW	0.02	0.05 0.06 to 0.08 0.10 to 0.13 0.08 to 0.09 0.10 to 0.11



Contents Overview

Chapter Overview

Type Index

R&S Addresses





Contents Overview

Chapter Overview

Type Index

R&amp;S Addresses



## Power Sensors R&amp;S®NRV-Z

Dimensions and weight	
R&S®NRV-Z1 to -Z15/-Z31/-Z51/-Z52	120 mm × 37 mm × 31 mm; 0.35 kg
R&S®NRV-Z32	190 mm × 37 mm × 31 mm; 0.42 kg
R&S®NRV-Z33/-Z53	240 mm × 54 mm × 60 mm; 0.53 kg
R&S®NRV-Z54	298 mm × 54 mm × 60 mm; 0.68 kg
Length of connecting cable	approx. 1.3 m; other lengths on request

## Ordering information

Peak Power Sensors		
50 Ω, 6 GHz, 20 mW		
Standard model	R&S®NRV-Z31	0857.9604.02
High-speed model	R&S®NRV-Z31	0857.9604.03
TDMA model	R&S®NRV-Z31	0857.9604.04
50 Ω, 6 GHz, 2 W		
TDMA model	R&S®NRV-Z32	1031.6807.04
General-purpose model	R&S®NRV-Z32	1031.6807.05
50 Ω, 6 GHz, 20 W		
High-speed model	R&S®NRV-Z33	1031.6507.03
TDMA model	R&S®NRV-Z33	1031.6507.04
Power Sensors		
20 mW, 50 Ω, 18 GHz	R&S®NRV-Z1	0828.3018.02
500 mW, 50 Ω, 18 GHz	R&S®NRV-Z2	0828.3218.02
13 mW, 75 Ω, 2.5 GHz	R&S®NRV-Z3	0828.3418.02
20 mW, 50 Ω, 6 GHz	R&S®NRV-Z4	0828.3618.02
500 mW, 50 Ω, 6 GHz	R&S®NRV-Z5	0828.3818.02
20 mW, 50 Ω, 26.5 GHz	R&S®NRV-Z6	0828.5010.03
20 mW, 50 Ω, 40 GHz	R&S®NRV-Z15	1081.2305.02
100 mW, 50 Ω, 18 GHz	R&S®NRV-Z51	0857.9004.02
100 mW, 50 Ω, 26.5 GHz	R&S®NRV-Z52	0857.9204.02
10 W, 50 Ω, 18 GHz	R&S®NRV-Z53	0858.0500.02
30 W, 50 Ω, 18 GHz	R&S®NRV-Z54	0858.0800.02
100 mW, 50 Ω, 40 GHz	R&S®NRV-Z55	1081.2005.02

## Measurement time in seconds (from trigger to output of first byte) depending on filter setting

Resolution	Filter number												
	0	1	2	3	4	5	6	7	8	9	10	11	12
R&S®NRV-Z1 to -Z15	0.045	0.05	0.06	0.08	0.15	0.27	0.49	0.95	1.85	3.6	7.2	14.5	28.5
R&S®NRV-Z31, mod. 02	1.04	1.04	1.05	1.07	1.13	1.24	1.44	1.84	2.7	4.3	7.5	14	27
R&S®NRV-Z31 to -Z33, mod. 03, 04	0.135	0.14	0.15	0.17	0.23	0.34	0.54	0.94	1.77	3.4	6.6	13	26
R&S®NRV-Z32, mod. 05	0.435	0.44	0.45	0.47	0.53	0.64	0.84	1.24	2.07	3.7	6.9	14	27
R&S®NRV-Z51 to -Z55	0.115	0.12	0.13	0.15	0.21	0.32	0.52	0.92	1.75	3.4	6.6	13	26
R&S®URV 5-Z2, -Z4, -Z7	0.065	0.07	0.08	0.1	0.2	0.38	0.72	1.45	2.8	5.5	11	22	44



Contents Overview

Chapter Overview

Type Index

R&amp;S Addresses





Contents Overview

Chapter Overview

Type Index

R&amp;S Addresses



## Power Reflection Meter R&S®NRT

200 kHz to 4 GHz

0.3 mW to 2000 W

Power and reflection measurements under operational conditions

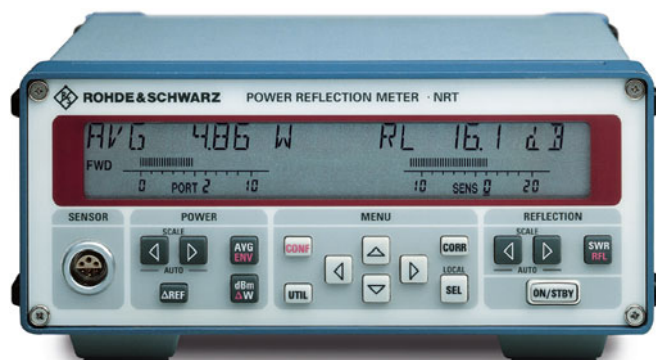

### Brief description

Directional power meters are used to measure power and reflection under operational conditions. Typical applications are in installation, maintenance and monitoring of transmitters, antennas and RF generators in industrial and medical fields. Power Reflection Meter R&S®NRT is the right choice: rugged, accurate and compact. Due to the large variety of measurement functions and high accuracy it is suitable for classic applications in mobile use as well as for use in research, development, production and quality management.

### Power Sensors R&S®NRT-Z43 and -Z44 for use in radiocommunications

The wide frequency range from 200 (400) MHz to 4 GHz covers all relevant frequency bands, the measurement method is compatible with all common analog and in particular digital modulation standards: GSM 900/1800/1900, DECT, PHS, NADC, PDC, DAB, DVB, IS-95-CDMA, WCDMA and many more.

### Power Sensors R&S®NAP-Z

The complete range of power sensors of the predecessor model R&S®NAP is available for the customary frequency ranges, e.g. shortwave, and can be connected via an option. The sensors cover all the main frequency bands, from the maritime radio frequencies in the range of 200 kHz through to the digital GSM900 network.

The power measurement range extends from 0.3 mW to 2 kW. The R&S®NAP sensors are able to measure the average power irrespective of the modulation mode and some of them even the peak envelope power (PEP). All R&S®NAP sensors up to 1 GHz have a directivity of at least 30 dB and thus allow very precise reflection and power measurements.

### Measurement directly on PC

The sensors of the R&S®NRT family are self-contained measuring instruments which are able to communicate with the basic unit or with a PC via a standard serial data interface. Interface Adapter R&S®NRT-Z3 allows connection to the serial RS-232-C standard interface of PCs (COMx), PC Card Interface Adapter R&S®NRT-Z4 operation at the PC card connector of laptops and notebooks. A program running under Windows (V-R&S®NRT) is available for operation of the sensor and display of the measurement results.



Direct power monitoring on PC

### Operation, measurement functions

Thanks to menu control, a manageable number of keys and a large display, operation of the R&S®NRT is extremely easy. Switchover between the main functions is made at a keystroke:

- ◆ Choice between average power, average burst power, peak envelope power (PEP) and peak-to-average power ratio (crest factor)
- ◆ Switchover between forward power and absorbed power
- ◆ Measurement of power differences in dB or %
- ◆ Choice between return loss, SWR or reflection coefficient in reflection measurements
- ◆ Acoustic SWR monitoring
- ◆ Indication of maximum and minimum values
- ◆ Quasi-analog bargraph display
- ◆ Choice between measurement at the source or at the load



Contents Overview

Chapter Overview

Type Index

R&amp;S Addresses



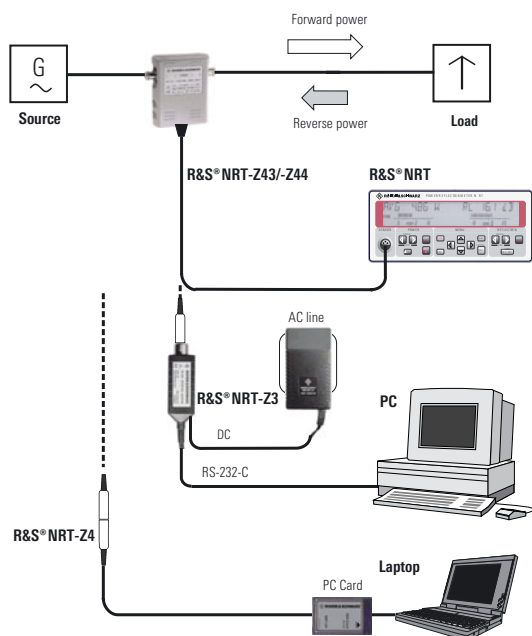

**Power and reflection measurement with R&S® NRT-Z43/-Z44: readout of results either on basic unit or directly on PC**

## Options

The R&S® NRT basic unit comes with an IEC-bus (IEEE488) and RS-232-C interface, both to SCPI standard. Three options allow the R&S® NRT to be adapted to different applications:

- ◆ Test input for connection of NAP sensors
- ◆ Two additional test inputs for R&S® NRT sensors for simultaneous monitoring of up to three testpoints (R&S® NRT-B2)
- ◆ Battery and built-in charger for mobile use (R&S® NRT-B3)

## Specifications in brief: power sensors

General data	R&S® NRT-Z43	R&S® NRT-Z44
Power measurement range <sup>1)</sup>	0.0007 W to 30 W (average)/75 W (peak)	0.003 W to 120 W (average)/300 W (peak)
Frequency range	400 MHz to 4 GHz	200 MHz to 4 GHz
SWR (referred to 50 Ω)	1.07 max. from 0.4 GHz to 3 GHz 1.12 max. from 3 GHz to 4 GHz	1.07 max. from 0.2 GHz to 3 GHz 1.12 max. from 3 GHz to 4 GHz
Insertion loss	0.06 dB max. from 0.4 GHz to 1.5 GHz 0.09 dB max. from 1.5 GHz to 4 GHz	0.06 dB max. from 0.2 GHz to 1.5 GHz 0.09 dB max. from 1.5 GHz to 4 GHz
Directivity	30 dB min. from 0.4 GHz to 3 GHz 26 dB min. from 3 GHz to 4 GHz	30 dB min. from 0.2 GHz to 3 GHz 26 dB min. from 3 GHz to 4 GHz
<b>Average power measurement <sup>2)</sup></b>		
Definition	mean value of carrier power, averaged over several modulation cycles (thermal equivalent, true rms value in case of voltage measurement)	
Power measurement range	0.007 W [0.0007] to 75 W (CW, FM, jM, FSK, GMSK or equivalent)	0.03 W [0.003] to 300 W (CW, FM, jM, FSK, GMSK or equivalent)
CF: peak-to-average power ratio (crest factor)	to 30 [3] W (CDMA, WCDMA, DAB, DVB) to 75 [7.5] W/CF (other modulation)	to 120 [12] W (CDMA, WCDMA, DAB, DVB) to 300 [30] W/CF (other modulation)
Modulation	for all kinds of analog and digital modulation; lowest frequency component of signal envelope should exceed 7 Hz for steady indication	
Measurement uncertainty at 18°C to 28°C	unmodulated RF (CW): 3.2% of rdg (0.14 dB)	unmodulated RF (CW): 3.2% of rdg (0.14 dB)
<b>Burst average power measurement <sup>2)</sup></b>		
Definition	average on-power of periodic carrier bursts, based on the measurement of average power under consideration of burst width t and repetition rate 1/T: burst average power = average power × T/t	
Power measurement range	0.007 [0.0007] W × $\frac{T}{t}$	0.03 [0.003] W × $\frac{T}{t}$
	up to specified upper limit of average power measurement	
Burst width (t)	0.2 μs to 150 ms	
Repetition rate (1/T)	7/s min.	
<b>Measurement of peak-to-average power ratio (crest factor)</b>		
Definition	ratio of peak envelope power to average power in dB (only with 1 → 2 forward direction)	
Power measurement range	see average power and peak envelope power specifications	
<b>Measurement of peak envelope power (PEP)</b>		
Definition	peak value of carrier power (only with 1 → 2 forward direction)	
Power measurement range	0.1 W (1)* to 75 W	0.4 W (4)* to 300 W
Burst signals (repetition rate min. 20/s)	(* lower measurement limit depending on modulation)	(* lower measurement limit depending on modulation)



Contents Overview

Chapter Overview

Type Index

R&S Addresses



Measurement of complementary cumulative distribution function (CCDF)	R&S®NRT-Z43		R&S®NRT-Z44			
Definition	probability in % of forward power envelope exceeding a given threshold (only with 1 → 2 forward direction)					
Measurement range	0% to 100%		0% to 100%			
Threshold level range	0.25 W to 75 W		1 W to 300 W			
<b>Reflection measurement <sup>2)</sup></b> (values in {} : 3 GHz to 4 GHz)						
Definition	measurement of load match in terms of SWR, return loss or reflection coefficient					
Reflection measurement range	0 dB to 23 {20} dB / 1.15 {1.22} to ∞ / 0.07 {0.10} to 1					
Return loss/SWR/reflection coefficient						
Min. forward power	0.007 [0.07] W (specs met from 0.05 [0.5] W)		0.03 [0.3] W (specs met from 0.2 [2] W)			
<b>General data</b>						
	R&S®NAP-Z3	R&S®NAP-Z4	R&S®NAP-Z5	R&S®NAP-Z6	R&S®NAP-Z7	R&S®NAP-Z8
Power measurement range <sup>1)</sup>	0.01 W to 35 W	0.03 W to 110 W	0.1 W to 350 W	0.3 W to 1100 W	0.05 W to 200 W	0.5 W to 2000 W
Frequency range	25 MHz to 1 GHz	25 MHz to 1 GHz	25 MHz to 1 GHz	25 MHz to 1 GHz	0.4 MHz to 80 MHz	0.2 MHz to 80 MHz
SWR (referred to 50 Ω)	1.03 max.	1.03 max.	1.03 max.	1.05 max.	1.03 max. (1.02 max. from 1.5 MHz to 30 MHz)	
Insertion loss						
up to 0.3 GHz	0.10 dB max.	0.08 dB max.	0.08 dB max.	0.05 dB max.	–	–
up to 0.5 GHz	0.25 dB max.	0.15 dB max.	0.15 dB max.	0.10 dB max.	–	–
total frequency range	0.75 dB max.	0.35 dB max.	0.20 dB max.	0.15 dB max.	0.015 dB max.	0.015 dB max.
Directivity	30 dB min. (30 MHz to 1 GHz), 26 dB min. (25 MHz to 30 MHz)			35 dB min. (1.5 MHz to 30 MHz)		
<b>Average power measurement</b>						
Measurement range	0.01 W to 35 W	0.03 W to 110 W	0.1 W to 350 W	0.3 W to 1100 W	0.05 W to 200 W	0.5 W to 2000 W
Measurement uncertainty at 20°C to 25°C	6% of reading	6% of reading	6% of reading	6% of reading	6 [4] % of reading (1.5 MHz to 30 MHz) value in brackets: sensor-specific calibration factors taken into account	
<b>Measurement of peak envelope power</b>						
Measurement range	not possible	not possible	not possible	not possible	0.5 W to 200 W	5 W to 2000 W
AM					30 Hz to 10 kHz	30 Hz to 10 kHz
Burst width t					20 μs min.	20 μs min.
Repetition rate 1/T					30/s min.	30/s min.
<b>Reflection measurement</b>						
Measurement range for return loss/SWR/reflection coefficient	0 dB to 23 dB / 1.15 to ∞ / 0.07 to 1 (30 MHz to 1 GHz)				0 dB to 28 dB/1.08 to ∞/0.04 to 1 (1.5 to 30 MHz)	
Minimum forward power	0.1 (0.6) W	0.3 (2) W	1 (6) W	3 (20) W	0.5 (10) W	5 (100) W
	specs met with power values in ( )					

General data	R&S®NAP-Z10 (model .02)	R&S®NAP-Z11 (model .02)
Power measurement range <sup>1)</sup>	0.005 W to 20 W	0.05 W to 200 W
Frequency range	35 MHz to 1 GHz	35 MHz to 1 GHz
SWR (referred to 50 Ω)	max. 1.03	max. 1.03
Insertion loss		
up to 0.3 GHz	0.10 dB max.	0.08 dB max.
up to 0.5 GHz	0.25 dB max.	0.15 dB max.
total frequency range	0.75 dB max.	0.20 dB max.
Directivity	30 dB min. from 40 MHz to 1 GHz 26 dB min. from 35 GHz to 40 GHz	
<b>Average power measurement</b>		
Measurement range	0.005 W to 20 W	0.05 W to 200 W
Measurement uncertainty at 20 to 25°C	6.5% of reading	6.5% of reading
<b>Measurement of peak envelope power</b>		
Measurement range	0.05 W to 20 W	0.5 W to 200 W
AM	50 Hz to 100 kHz	50 Hz to 100 kHz
Burst width t	min. 4,5 μs	min. 4,5 μs
Repetition rate 1/T	min. 50/s	min. 50/s
<b>Reflection measurement</b>		
Measurement range Return loss/SWR/Reflection coefficient	0 dB to 23 dB/1.15 to ∞/0.07 to 1 (40 MHz to 1 GHz)	
Minimum forward power	0.05 (0.35) W	0.5 (3.5) W
	specs met with power values in ( )	
Measurement time	equal to measurement time of selected power measurement function, shortest with average power measurement	



Contents Overview

Chapter Overview

Type Index

R&S Addresses





Contents Overview

Chapter Overview

Type Index

R&amp;S Addresses



## Specifications in brief: R&amp;S®NRT basic unit

You will find detailed and binding data on the enclosed CD (./DATASHEET/NRT.pdf), or, for the latest updates, visit [www.rohde-schwarz.com](http://www.rohde-schwarz.com), search term: NRT

Measurement functions	
Power	forward power and power absorbed by the load in W, dBm, dB or % (dB and % referred to measured value or reference value)
Power parameters <sup>3)</sup>	average, burst average, envelope peak, peak-to-average ratio (crest factor) and complementary cumulative distribution function (CCDF)
Reflection	SWR, return loss, reflection coefficient, reverse forward power ratio and reverse power
Frequency response correction	upon input of RF frequency, the stored correction factors of the power sensor being taken into account; for NAP sensors the R&S®NRT basic unit offers memory for 3 sets of calibration factors
Digital	simultaneous indication of power, reflection and frequency
Resolution	HIGH: 4½ digits (0.001 dB) LOW: 3½ digits (0.01 dB)
Analog	two 50-element bargraphs for indication of power and reflection with selectable or predefined scale-end values
Averaging	automatic, depending on selected resolution and sensor characteristics
Max/Min.	indication of current maximum, minimum or maximum value for the selected measurement functions
Remote control	IEC/IEEE bus
Serial interface	9-pin sub-D connector to EIA-232E
General data	
Power supply	
AC supply	100 to 240 V, 50 Hz to 60 Hz or 100 to 120 V, 400 Hz; 35 VA, max. 0.4 A
Battery	with option R&S®NRT-B3, operating time approx. 8 h with one R&S®NRT-Z power sensor and option R&S®NRT-B1; recharging within 2 hours in quick-charge mode
Dimensions	219 mm × 103 mm × 240 mm
Weight	3.5 kg with all options
Power Sensors R&S®NRT-Z43/-Z44	
Measurement channels	2 (for forward and reverse power)
Forward dir. 1 → 2	standard for all measurement functions
Forward dir. 2 → 1	only for measurement of average and burst average power (at low levels)
Measurement functions	forward power and reflection
Power parameters	average, burst average, envelope peak, peak-to-average ratio and complementary cumulative distribution function (CCDF)
Reflection	return loss, SWR, reflection coefficient, reverse power
Range selection	automatic
Video bandwidth	4 kHz, 200 kHz and "FULL" available for all power parameters except average power measurement
Frequency response correction	upon input of RF frequency, the stored correction factors of both measurement channels being taken into account
RF connectors	N (female) on both ends
Remote control	via serial RS-422 interface, 6-pin LEMOSA connector

General data	
Power supply	6.5 to 28 V, approx. 1.5 W
Length of extension cable	max. 500 m with 12 V supply voltage (via R&S®NRT-Z3, R&S®NRT-Z4 or line-operated R&S®NRT) max. 30 m with 7 V supply voltage (battery-operated R&S®NRT)
Dimensions (W × H × D)	120 mm × 95 mm × 39 mm
Weight	0.65 kg
Power measurement with R&S®NAP power sensors and option R&S®NRT-B1	
Measurement channels	2 identical channels (for forward and reverse power)
Range selection	automatic
Frequency response correction	with NAP-Z7 and NAP-Z8 under consideration of calibration factors
Zero adjustment	with RF level switched off, duration approx. 5 s
RF connectors	N male/N female (NAP-Z6: 7/16 male, 7/16 female)
Length of connecting cable	1.5 m

## Ordering information

<b>Power Reflection Meter</b>	R&S®NRT	1080.9506.02
<b>Power Sensors R&amp;S®NRT (incl. R&amp;S®NRT software)</b>		
30 (75) W, 0.4 GHz to 4 GHz	R&S®NRT-Z43	1081.2905.02
120 (300) W, 0.2 GHz to 4 GHz	R&S®NRT-Z44	1081.1309.02
<b>Power Sensors R&amp;S®NAP</b>		
35 W, 25 MHz to 1000 MHz	R&S®NAP-Z3	0392.6610.55
110 W, 25 MHz to 1000 MHz	R&S®NAP-Z4	0392.6910.55
350 W, 25 MHz to 1000 MHz	R&S®NAP-Z5	0392.7116.55
1100 W, 25 MHz to 1000 MHz	R&S®NAP-Z6	0392.7316.56
200 W, 0.4 MHz to 80 MHz	R&S®NAP-Z7	0350.8214.02
2000 W, 0.2 MHz to 80 MHz	R&S®NAP-Z8	0350.4619.02
20 W, 35 MHz to 1000 MHz	R&S®NAP-Z10	0858.0000.02
200 W, 35 MHz to 1000 MHz	R&S®NAP-Z11	0852.6707.02
<b>Options</b>		
Interface for NAP-Z Power Sensors	R&S®NRT-B1	1081.0902.02
2 rear inputs for		
R&S®NRT-Z Power Sensors	R&S®NRT-B2	1081.0702.02
Battery supply with built-in charger and NiMH battery	R&S®NRT-B3	1081.0502.02
<b>Recommended extras</b>		
NiMH Battery	R&S®NRT-Z1	1081.1209.02
Extension Cable		
for R&S®NRT-Z Power Sensors 10 m	R&S®NRT-Z2	1081.2505.10
for R&S®NRT-Z Power Sensors 30 m	R&S®NRT-Z2	1081.2505.30
for R&S®NAP-Z Power Sensors 25 m	R&S®NAP-Z2	0392.5813.02
RS-232-C Interface Adapter for R&S®NRT-Z Power Sensors including AC Power Supply	R&S®NRT-Z3	1081.2705.02
PC Card Interface Adapter for R&S®NRT-Z Power Sensors	R&S®NRT-Z4	1120.5005.02
Carrying Bag with Straps and Pocket of Accessories	R&S®ZZT-222	1001.0500.00
19" Rack Adapter	R&S®ZZA-97	0827.4527.00

1) Dependent on measurement function.

2) Values in [ ]: 2→1 forward direction (if different from 1→2 forward direction).

3) Sensor-dependent.



Contents Overview

Chapter Overview

Type Index

R&amp;S Addresses







Contents Overview

Chapter Overview

Type Index

R&amp;S Addresses



## Directional Power Meter R&amp;S®NAS

1 MHz to 1990 MHz

10 mW to 1200 W

Convenient and precise power and SWR measurements in the entire field of radiotelephony

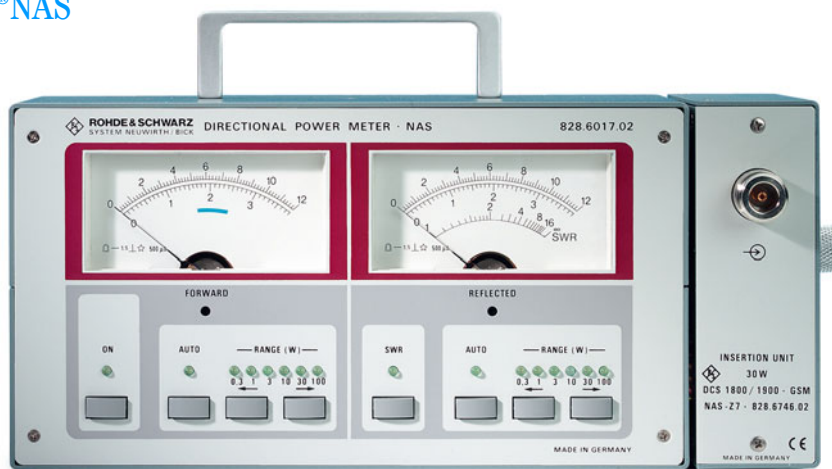

## Brief description

Directional Power Meter R&S®NAS is the ideal servicing unit wherever power and SWR of all kinds of radio equipment have to be measured. Insertion units for mobile radio make the R&S®NAS a versatile unit and an investment for the future.

## Main features

- ◆ Two moving-coil meters
- ◆ Autoranging
- ◆ Battery operation
- ◆ Automatic switchoff
- ◆ High EMI immunity
- ◆ Excellent price/performance ratio

## Operation

Operation of the R&S®NAS is extremely simple and reliable thanks to microprocessor control. Forward and reflected power or forward power and SWR are simultaneously indicated on two large meters. Indication of SWR does away with the cumbersome use of tables.

## Insertion units

Insertion units are either plugged to the side of the R&S®NAS or connected via a 1.5 m long cable for measurements at test points that are difficult to reach. Each insertion unit contains its individual calibration data which are read by the R&S®NAS and considered in the measurement results.

## GSM 900/1800/1900 applications

Insertion Units R&S®NAS-Z6 and -Z7 measure the peak envelope power (PEP) of the clocked signal with due consideration of the timing laid down in the GSM specifications. Therefore the insertion units are ideal too for measurements on mobile stations which according to definition are sending signals in only one of the eight timeslots. Transient overshoots of the signal bursts are eliminated by a signal-controlled circuit so that the forward and reflected power as well as the SWR can be correctly measured and indicated.

## Standard applications

The standard Insertion Unit R&S®NAS-Z5 with its wide frequency range is suitable for almost any application and practically covers all commercial analog RT services including air navigation.

## Shortwave applications

Insertion Units R&S®NAS-Z1 and -Z2 have been especially designed for the frequency range up to 30 MHz.

R&S®NAS-Z2 is for powers up to 1200 W for use in long-range shortwave communication systems.

## Terminated power measurements

For measurements on transmitters, a Termination R&S®NAZ 10 or R&S®NAZ 30 acting as a dummy antenna is connected to the output of the insertion unit.



Contents Overview

Chapter Overview

Type Index

R&amp;S Addresses





Contents Overview

Chapter Overview

Type Index

R&S Addresses



## Directional Power Meter R&S®NAS

### Specifications in brief: Insertion Units R&S®NAS-Z

Model	R&S®NAS-Z1	R&S®NAS-Z2	R&S®NAS-Z3	R&S®NAS-Z5	R&S®NAS-Z6	R&S®NAS-Z7
Frequency range	1 MHz to 30 MHz	1 MHz to 30 MHz	25 MHz to 200 MHz	70 MHz to 1000 MHz	890 MHz to 960 MHz <sup>1)</sup>	890 MHz to 960 MHz <sup>1)</sup> and 1710 to 1990 MHz
Power measurement range	0.01 W to 120 W	0.1 W to 1200 W	0.01 W to 120 W	0.01 W to 120 W	0.01 W to 120 W	0.01 W to 30 W <sup>6)</sup>
Accuracy (of rdg)	±4.5%	±6.5%	±5.5%	±6.5% <sup>2)</sup>	±5.5%	±6/8.5% (≤20 W) <sup>5)</sup> , ±7/9.5% (<30 W) <sup>5)</sup>
SWR	<1.07	<1.07	<1.07	<1.07 <sup>3)</sup>	<1.1	<1.15
Directivity	>30 dB	>30 dB	>30 dB	>30 dB <sup>4)</sup>	>26 dB	>26 dB
Connector, characteristic impedance	N female, 50 Ω					
Dimensions (W × H × D); weight	55 mm × 120 mm × 90 mm; 0.7 kg					

1) Useful frequency range: 100 MHz to 1000 MHz for R&S®NAS-Z6, 850 MHz to 2000 MHz for R&S®NAS-Z7 (with wider error tolerances).

2) 100 MHz to 1000 MHz; 75 MHz to 100 MHz: -11 to +5.5% of reading; 70 to 75 MHz: -15 to -5.5% of reading.

3) f < 500 MHz; at f ≥ 500 MHz: < 1.1.

4) f < 500 MHz; at f ≥ 500 MHz: > 26 dB.

5) Wider error tolerances are valid within a frequency range of 1880 MHz to 1990 MHz.

6) Up to 100 W with wider error tolerances.

### Specifications in brief: basic unit

Display	two moving-coil meters for forward and reflected power, plus SWR indication
Range selection	automatic or manual, separate for forward and reflected power
Accuracy (18°C to 28°C)	±1.5% of selected range + error of power sensor
Additional uncertainty at temperatures >28°C and <18°C	≤0.25% of rdg/°C
Automatic switchoff	approx. 1 h after last keystroke
<b>General data</b>	
Power supply	5 dry batteries IEC R20, service life >150 h (alkaline-manganese batteries)
Dimensions (W × H × D); weight	210 mm × 145 mm × 90 mm; 2 kg

### Ordering information

Directional Power Meter	R&S®NAS	0828.6017.02
Insertion Unit	R&S®NAS-Z1	0828.6317.02
	R&S®NAS-Z2	0828.6417.02
	R&S®NAS-Z3	0828.6517.02
	R&S®NAS-Z5	0828.6717.03
for GSM900	R&S®NAS-Z6	0828.6723.02
for GSM 900/1800/1900	R&S®NAS-Z7	0828.6746.02
<b>Recommended extras</b>		
Connecting Cable (1.5 m) for detached operation of insertion units	R&S®NAS-Z9	0828.6969.02
Carrying Bag	R&S®NAS-Z10	0828.6917.02

Termination	R&S®NAZ10	R&S®NAZ30
Power-handling capacity (for 1 min)	10 W (15 W)	30 W (50 W)
Frequency range	0 Hz to 2 GHz	0 Hz to 4 GHz
VSWR	≤1.15	≤1.1 to 2 GHz
Connector, impedance	N male, 50 Ω	N male, 50 Ω
Order number	1029.2408.02	1029.2508.02



Contents Overview

Chapter Overview

Type Index

R&S Addresses





Contents Overview

Chapter Overview

Type Index

R&amp;S Addresses



## Level Meter R&amp;S®URV35

DC to 3/40 GHz

200  $\mu$ V to 1000 V; 100 pW to 30 W

Power and voltage measurement with  
a unique analog/digital display

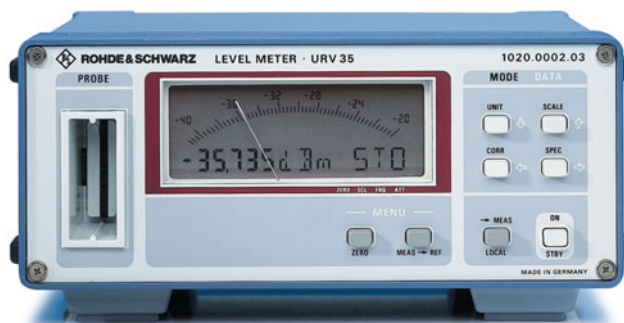

## Brief description

R&S®URV35 is a voltmeter and power meter for versatile applications in service and production as well as for precision measurements in RF and microwave labs. A large variety of probes and sensors allows voltage measurements up to 3 GHz and power measurements up to 40 GHz.

## Main features

- ◆ Compact, handy and mobile
- ◆ Voltmeter and power meter in one unit
- ◆ Rugged design
- ◆ Combined (true) analog and digital display
- ◆ Menu-guided operation
- ◆ AC-supply or battery operation

- ◆ Large choice of probes and sensors
- ◆ DC frequency input for tracking frequency-response correction
- ◆ Analog output for YT recorder
- ◆ RS-232-C interface
- ◆ Test generator for checking the probe or sensor (optional)

Specifications in brief,  
voltage probes page 311, power sensors page 298

You will find detailed and binding data on the enclosed CD (./DATASHEET/URV35.pdf), or, for the latest updates, visit [www.rohde-schwarz.com](http://www.rohde-schwarz.com), search term: URV35

Probes and sensors	all R&S®URV5 probes and R&S®NRV sensors
Display	backlight LCD, moving-coil meter with short response time
Absolute readout	dBm, dB $\mu$ V, V or W
Relative readout	dB, referred to stored reference value
Resolution of digital display	4½ digits: 19999 steps; 0.001 dB 3½ digits: 1999 steps; 0.01 dB
Analog display	steps of 1-2.5-5 for V, W and dB, 5 (10) dB for dBm and dB $\mu$ V with windows of 10 (20) dB
Entry of scaling	left- and right-hand scale limits
Display filtering	level-dependent digital averaging filter
Accuracy (18°C to 28°C)	
Digital display	±0.02 dB ±1 digit
Moving-coil meter	1.5% of full scale
Zero adjustment	via interface or manually, approx. 4 s
Hold function	for displayed measurement result
Measurement rate	5 readouts/s in manual mode
Frequency-response correction (selectable)	sensor-specific calibration data taken into account
Attenuation compensation (selectable)	external attenuation or gain taken into account, range ±199.99 dB
Entry of reference value	measured value on keystroke, or value entered via interface or keypad
Reference impedance	50 $\Omega$ /75 $\Omega$ , automatic/selectable
<b>Interfaces</b>	
Remote control	serial interface (V.24, RS-232-C)
DC frequency input	BNC, $R_{in} = 9 \text{ M}\Omega$
Input voltage range	±12 V, linear with selectable scale

DC voltage output	BNC, $R_{out} = 1 \text{ k}\Omega$ , EMF proportional to pointer deflection
Left-/right-hand scale limit	corresponding to 0/+3 V
Additional settling time	250 ms
Accuracy	±5 mV

**General data**

Model .02 power supply	
Battery, standard	5 × 1.5 V alkaline-manganese LR20
Operating time	125 h
Rechargeable battery, retrofittable	5 × 1.2 V NiCd IEC KR35/62
Operating/charging time	60 h/24 h
AC supply with	
R&S®UZ-35, European version	230 V ±10%, 47 to 63 Hz
R&S®UZ-35, US version	120 V ±10%, 57 to 63 Hz
Model .03 (AC supply)	115 V +15%/-22%, 47 to 440 Hz 230 V +15%/-22%, 47 to 63 Hz (switch-selectable); 6 VA
Dimensions (W × H × D)	220 mm × 100 mm × 240 mm
Weight model .02	3.1 kg/2.3 kg with/without batteries
Weight model .03	2.4 kg

## Ordering information

**Level Meter**

battery-operated	R&S®URV35	1020.0002.02
AC-supply model	R&S®URV35	1020.0002.03
<b>Options</b>		
Sensor Check Source	R&S®NRVS-B1	1029.2908.02
Power Supply/Charger (for model .02) <sup>1)</sup>	R&S®UZ-35	1020.1709.02
Power Supply/Charger (for model .02) <sup>2)</sup>	R&S®UZ-35	1020.1709.04
Service Kit	R&S®URV35-S1	1029.2608.02

1) European power supply.

2) US power supply.



Contents Overview

Chapter Overview

Type Index

R&amp;S Addresses



## Millivoltmeter R&amp;S®URV5

DC, 9 kHz to 3/26.5 GHz

200  $\mu$ V to 1000 V

Voltage, level, power measurements; trend indication



## Brief description

Millivoltmeter R&S®URV5 is a broadband voltage, level and power meter of high accuracy and sensitivity. It is suitable both for manual operation and for use in systems. A wide choice of individually calibrated probes and sensors allows R&S®URV5 to be used for a great variety of measurements:

- ◆ With RF probe and DC probe for no-load AC and DC voltage measurements
- ◆ Voltage (and power) measurements in coaxial 50  $\Omega$  and 75  $\Omega$  systems using low-reflection and low-loss insertion units
- ◆ Power measurements up to 26.5 GHz using Power Sensors R&S®NRV-Z1 to -Z6

## Main features

- ◆ Two test inputs
- ◆ High accuracy through  $\mu$ P-controlled error correction:  $\pm 1\%$
- ◆ Dynamic range >94 dB
- ◆ IEC/IEEE-bus interface
- ◆ Readout in all standard units with selectable reference impedance; relative measurements
- ◆ Optional DC output
- ◆ PEP measurement

## Specifications in brief, voltage probes page 311, power sensors page 298

You will find detailed and binding data on the enclosed CD (./DATASHEET/URV5.pdf), or, for the latest updates, visit [www.rohde-schwarz.com](http://www.rohde-schwarz.com), search term: URV5

Probes and sensors	all R&S®URV5 probes and R&S®NRV sensors, except R&S®NRV-Z3x and R&S®NRV-Z5x, -Z15					
Test channels	2 (A and B)					
Absolute measurement	A, B					
Relative measurement	A/REF <sub>A</sub> , B/REF <sub>B</sub> , A/B, B/A					
Absolute readout	V, W, dBm, dBV					
Relative readout	$\Delta$ V, $\Delta$ W, $\Delta$ %, $\Delta$ dB, X/REF					
Resolution	0.01% or 0.01 dB					
Accuracy of voltage readout in V (18°C to 28°C)	$\pm 0.15\%$ of rdg per channel					
Filter	to reduce display noise in 6 steps (F0 to F5), selectable					
Zero adjustment	via keyboard or remote control					
Measurement rate (manual)	approx. 1 measurement/s with filter F0, up to 30 measurements/s with filter F5					
Measurement time (IEC/IEEE bus)	approx. 0.05 s with filter F5, up to 20 s with filter F0					
PEP measurement						
Pulse width	approx. 200 $\mu$ s to CW					
Min. pulse repetition frequency						
Filter	F0	F1	F2	F3	F4	F5
$f_{\min}/\text{Hz}$	0.05	0.25	1	5	25	100

Frequency-response correction (selectable)	sensor-specific frequency response after entry of test frequency
Attenuation compensation (selectable)	one attenuation value per channel can be entered ( $-199.99$ dB to $+199.99$ dB)
Reference value for relative measurements	one value per channel

## Optional DC Output R&amp;S®URV5-B2

Output voltage range (EMKF)	$-1.999$ V to $+1.999$ V, $R_{\text{out}} = 1$ k $\Omega$
Resolution; error	1 mV (10 digit); $\pm 2$ mV

## General data

Remote control	IEC625-1 (IEEE 488) for control of all instrument functions
Power supply	100/120/220/240 V $\pm 10\%$ , 47 Hz to 63 Hz, 400 Hz, 30 VA
Dimensions (W $\times$ H $\times$ D)	241 mm $\times$ 110 mm $\times$ 340 mm
Weight	4.4 kg

## Ordering information

Millivoltmeter	R&S®URV5	0394.8010.02
Options		
DC Output	R&S®URV5-B2	0079.0631.00
Service Kit for Calibration	R&S®UZ-8	0394.9968.02



Contents Overview

Chapter Overview

Type Index

R&amp;S Addresses



## Millivoltmeter R&amp;S®URV55

DC to 3/40 GHz

200  $\mu$ V to 1000 V

100 pW to 30 W

RF/DC voltage, level and power

measurements

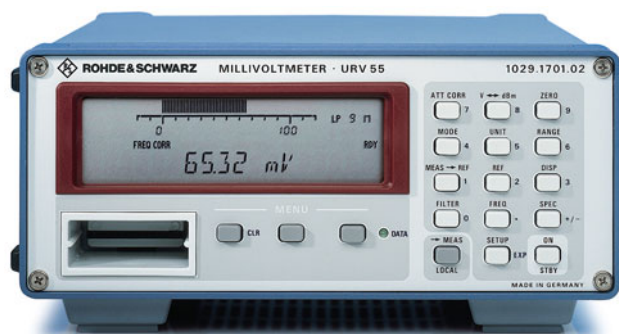

## Brief description

Millivoltmeter R&S®URV55 is suitable for voltage measurements up to 3 GHz as well as for power and level measurements up to 40 GHz. Thanks to probes with calibration data memory and temperature sensors, which make adjustments by the user superfluous, R&S®URV55 provides at all times high-precision measurements free of operator's errors.

## Main features

- ◆ Voltage, level and power measurements
- ◆ Large choice of intelligent probes and sensors (R&S®URV5-Z, R&S®NRV-Z)
- ◆ IEC/IEEE-bus interface
- ◆ DC frequency input for tracking frequency-response correction
- ◆ Analog output for YT recorder
- ◆ Storage of 20 complete instrument setups
- ◆ 13 digital filters for noise suppression, automatic or manual filter selection
- ◆ Sensor check source (optional)

## Measuring heads

The range of measuring heads includes high-impedance probes with plug-on dividers and adapters (R&S®URV5-Z7, -Z1) as well as insertion units for voltage measurements on coaxial lines (R&S®URV5-Z2, -Z4). All power sensors of the R&S®NRV-Z series can be used without any restrictions.

## Measurement time in seconds (from trigger to output of first byte) depending on filter setting

Resolution	Filter number												
	0	1	2	3	4	5	6	7	8	9	10	11	12
R&S®NRV-Z1 to -Z15	0.045	0.05	0.06	0.08	0.15	0.27	0.49	0.95	1.85	3.6	7.2	14.5	28.5
R&S®NRV-Z31, mod. 02	1.04	1.04	1.05	1.07	1.13	1.24	1.44	1.84	2.7	4.3	7.5	14	27
R&S®NRV-Z31 to -Z33, mod. 03, 04	0.135	0.14	0.15	0.17	0.23	0.34	0.54	0.94	1.77	3.4	6.6	13	26
R&S®NRV-Z32, mod. 05	0.435	0.44	0.45	0.47	0.53	0.64	0.84	1.24	2.07	3.7	6.9	14	27
R&S®NRV-Z51 to -Z55	0.115	0.12	0.13	0.15	0.21	0.32	0.52	0.92	1.75	3.4	6.6	13	26
R&S®URV 5-Z2, -Z4, -Z7	0.065	0.07	0.08	0.1	0.2	0.38	0.72	1.45	2.8	5.5	11	22	44



Contents Overview

Chapter Overview

Type Index

R&amp;S Addresses





Contents Overview

Chapter Overview

Type Index

R&amp;S Addresses



## Millivoltmeter R&amp;S®URV55

Specifications in brief,  
voltage probes page 311, power sensors page 298

You will find detailed and binding data on the enclosed CD  
(../DATASHEET/URV55.pdf), or, for the latest updates, visit  
[www.rohde-schwarz.com](http://www.rohde-schwarz.com), search term: URV55

<b>Measurement functions</b>	average power, pulse power, peak envelope power, AM, reflection, DC voltage (depending on sensor)
<b>Frequency and level range</b>	DC to 40 GHz, 100 pW to 30 W 9 kHz to 3 GHz, 200 mV to 1000 V (depending on sensor)
<b>Probes and sensors</b>	all R&S®NRV sensors and R&S®URV5 probes
<b>Display</b>	LCD for digits, units, menu-guided operation and analog display, adjustable backlighting
Display of results	single-channel (with optional display of correction frequency) or dualchannel
Absolute readout	W, dBm, V, dBmV
Relative readout	dB, %W or %V relative to a stored reference value
Analog display	automatic or with selectable scale
Digital display and resolution	max. 4½ digits, resolution selectable (0.1/0.01/0.001 dB)
Display filtering	averaging over 1 to 512 readings to reduce display noise; manual or automatic setting depending on measurement range and resolution
Display noise	see sensors from page 311/298
<b>Measurement rate</b>	see table on previous page
<b>Accuracy (without sensor)</b>	
18°C to 28°C	±0.02 dB ±1 digit
10°C to 40°C	±0.04 dB ±1 digit
0°C to 50°C	±0.06 dB ±1 digit
<b>Zero adjustment</b>	manual or via IEC/IEEE bus, duration approx. 4 s
<b>Frequency response correction</b>	sensor-specific calibration data taken into account; numerical entry of test frequency (keyboard or via IEC/IEEE bus) or by frequency-proportional DC voltage

Attenuation compensation	external attenuation or gain taken into account; data entry via keyboard or IEC/IEEE bus, range ±200 dB
Entry of reference value	measured value on keystroke or numerical entry via keypad or IEC/IEEE bus
Reference impedance	for conversion between voltage and power, automatic readout of reference impedance from sensor data memory or numerical entry via keyboard or IEC/IEEE bus (for RF probe)
<b>Remote control</b>	IEC625 (IEEE488), control of all instrument functions
<b>DC frequency input</b>	
Connector	BNC
Input voltage range	±12 V, linear with selectable scale
<b>DC output</b>	
Connector	BNC, $R_{out} = 1 \text{ k}\Omega$ , EMF proportional to analog display
Left-/right-hand full-scale value	corresponding to 0/+3 V
Accuracy	±5 mV
Channels	1, 2
<b>Sensor check source</b>	option R&S®NRVS-B1
Output power	1 mW ±0.7%
Frequency	50 MHz
VSWR	1.05
RF connector	N female
<b>General data</b>	
Power supply	115 V +15/-22% (-15%) 47 Hz to 63 (440) Hz 230 V +15/-22%, 47 Hz to 63 Hz, 13 VA
Dimensions (W × H × D)	219 mm × 103 mm × 350 mm
Weight	3.2 kg

## Ordering information

<b>Millivoltmeter</b>	R&S®URV55	1029.1701.02
<b>Option</b>		
Sensor Check Source	R&S®NRVS-B1	1029.2908.02
<b>Recommended extras</b>		
Rack adapter	R&S®ZZA-97	827.4527.00
Transit case for R&S®URV55, sensors and accessories	R&S®UZ-24	1029.3379.02
Service Kit	R&S®NRVS-S1	1029.2708.02



Contents Overview

Chapter Overview

Type Index

R&amp;S Addresses





Contents Overview

Chapter Overview

Type Index

R&amp;S Addresses



## Probes and Insertion Units R&amp;S®URV5-Z1/Z2/Z4/Z7/Z9 for voltage and level measurement



RF Probe R&amp;S®URV5-Z7



DC Probe R&amp;S®URV5-Z1

**Brief description**

R&S®URV5-Z probes and insertion units are indispensable tools for RF and microwave labs, test departments and service. They cover the frequency range from 9 kHz to 3 GHz and thus fill the gap between low-frequency voltage measurement at one end and microwave power measurement at the other end.

All corrections of the rectifier such as linearization, temperature compensation or frequency-response correction are made numerically. Each probe or insertion unit has a built-in calibration data memory with its individual data which are continuously read by the meter.

All AC probes read out the RMS value for unmodulated sinewave voltages.

**RF Probe R&S®URV5-Z7**

A versatile tool for measuring high-frequency voltages. Thanks to its low input capacitance of 2.5 pF ideal for practically no-load measurements on non-coaxial circuits up to about 500 MHz (with accessories up to 1 GHz). Measurement range with plug-on dividers 1000 V (input capacitance 0.5 pF).

**Accessory Set R&S®URV-Z6**

- ◆ Plug-on divider 20 dB and 40 dB for extending the measurement range and reducing the input capacitance to 100 V/1 pF or 1000 V/0.5 pF
- ◆ BNC adapter for level measurements on coaxial 50 Ω lines (see also Insertion Units R&S®URV5-Z2, -Z4)

**Adapters R&S®URV-Z50 (50 Ω)**

With integrated termination for power measurements on matched sources.

**DC Probe R&S®URV5-Z1**

Due to its low input capacitance ideal for DC voltage measurements on high-frequency modules.

**Insertion Units R&S®URV5-Z2 (50 Ω), R&S®URV5-Z4 (50 Ω)**

Insertion units are used for non-interrupting level measurements between source and load and for power measurements with wide dynamic range. They are made up of a short, reflection-free and low-loss line section with voltage tap and rectifier in the middle of the line.

With a well-matched load, the transmitted power  $P$  can be calculated for the measured voltage  $V_{\text{rms}}$  and the characteristic impedance  $Z_0$  according to the formula  $P = V_{\text{rms}}^2 / Z_0$ .



Contents Overview

Chapter Overview

Type Index

R&amp;S Addresses





Contents Overview

Chapter Overview

Type Index

R&S Addresses



## Specifications in brief

The indicated measurement uncertainties are valid in the temperature range 18°C to 28°C. Influences of the basic unit, meter noise, zero error, mismatch and temperature effects (beyond the indicated range) must also be taken into account.

Model	Frequency range Impedance	Voltage measurement range	Power measurement range	Max. VSWR (reflection coefficient)		Measurement uncertainty in dB (% of voltage)		RF connector
		Max. load	Level meas. range					
RF Probe R&S®URV5-Z7	20 kHz to 500 MHz 2.5 pF/80 kΩ	200 μV to 10 V 15 V (RMS) 22 V (PK) 400 V (DC)	1 nW to 2 W -60/+33 dBm	-	-	0.07 to 1.1	(0.8 to 12)	BNC female/ female <sup>1)</sup>
with 20 dB divider (R&S®URV-Z6)	1 to 500 MHz 1 pF/1 MΩ	2 mV to 100 V 150 V (RMS) 220 V (PK) 1000 V (DC)	100 nW to 20 W -40/+43 dBm	-	-	1.1 to 1.9	(12 to 20)	BNC female/ female <sup>1)</sup>
with 40 dB divider (R&S®URV-Z6)	0.5 to 500 MHz 0.5 pF/10 MΩ	20 mV to 1000 V 1050 V (RMS) 1500 V (PK) 1000 V (DC)	10 μW to 20 W -20/+43 dBm	-	-	0.63 to 1.9	(7.3 to 20)	BNC female/ female <sup>1)</sup>
with 50-Ω Adapter R&S®URV-Z50	20 kHz to 1 GHz 50 Ω	200 μV to 10 V 10 V (RMS) 22 V (PK)	1 nW to 2 W -60/+33 dBm	20 to 50 kHz >0.05 to 50 MHz >50 to 100 MHz >100 to 500 MHz >500 to 700 MHz >0.7 to 1 GHz	1.03 (0.015) 1.03 (0.015) 1.06 (0.030) 1.11 (0.050) 1.22 (0.10) 1.44 (0.18)	0.90 0.12 to 0.20 0.20 0.30 to 0.63 1.0 to 1.4 1.0 to 1.4	(10) (1.3 to 2.3) (2.3) (3.3 to 7.3) (11 to 18) (11 to 18)	BNC female (male)
DC Probe R&S®URV5-Z1	3 pF/9 MΩ	1 mV to 100 V 400 V (PK)	-	-	-	0.013 dB 0.030 dB	(0.15%) <sup>2)</sup> (0.35%) <sup>3)</sup>	BNC male
10 V Insertion Unit R&S®URV5-Z2	9 kHz to 3 GHz 50 Ω	200 μV to 10 V 15 V (RMS) 22 V (PK) 50 V (DC)	1 nW to 2 W -60/+33 dBm	9 kHz to 20 kHz >20 kHz to 50 kHz >50 kHz to 200 MHz >200 MHz to 500 MHz >500 MHz to 1 GHz >1.0 GHz to 2.0 GHz >2.0 GHz to 3.0 GHz	1.04 (0.02) 1.04 (0.02) 1.04 (0.02) 1.10 (0.048) 1.22 (0.10) 1.35 (0.15) 1.35 (0.15)	0.20 to 0.35 0.17 to 0.20 0.13 to 0.17 0.20 to 0.25 0.25 to 0.30 0.30 to 0.50 0.40 to 0.75	(2.3 to 4) (2.0 to 2.3) (1.5 to 2.0) (2.3 to 2.8) (2.8 to 3.4) (3.4 to 5.6) (4.5 to 8.3)	N female/male
100 V Insertion Unit R&S®URV5-Z4	100 kHz to 3 GHz 50 Ω	2 mV to 100 V 150 V (RMS) 220 V (PK) 1000 V (DC)	100 nW to 200 W -40/+53 dBm	100 kHz to 200 kHz >200 kHz to 500 kHz >0.5 MHz to 3 MHz >3 MHz to 200 MHz >200 MHz to 500 MHz >0.5 GHz to 1 GHz >1 GHz to 2 GHz >2 GHz to 3 GHz	1.04 (0.02) 1.04 (0.02) 1.04 (0.02) 1.04 (0.02) 1.04 (0.02) 1.07 (0.035) 1.07 (0.035) 1.10 (0.048)	0.50 to 1.50 0.25 to 0.60 0.13 to 0.20 0.13 0.17 to 0.20 0.20 to 0.25 0.30 to 0.50 0.45 to 1.05	(5.6 to 16) (2.8 to 6.7) (1.5 to 2.3) (1.5) (2.0 to 2.3) (2.3 to 2.8) (3.4 to 5.6) (5.0 to 11.4)	N female/male

## Ordering information

<b>DC Probe</b> with ground cable, clip tip and BNC adapter	R&S®URV5-Z1	0395.0512.02
<b>10 V Insertion Unit</b> (50 Ω, 3 GHz)	R&S®URV5-Z2	0395.1019.02
<b>100-V Insertion Unit</b> (50 Ω, 3 GHz)	R&S®URV5-Z4	0395.1619.02
RF Probe with case, ground cable, ground sleeve and tape, hook and sol- der tip	R&S®URV5-Z7	0395.2615.02
<b>Accessory Set for RF Probe</b> Plug-on divider 20 dB and 40 dB, BNC adapter 50 Ω, reducing sleeve for divid- er, ground sleeves and ground tape	R&S®URV-Z6	0292.5364.02
<b>50 Ω Terminating Adapter</b> BNC female connector, with adapter to BNC male	R&S®URV-Z50	0394.9816.50

1) With BNC adapter (R&S®URV-Z6); maximum power is limited by power loss of the adapter.

2) 1 mV to 100 V.

3) 100 V to 400 V.



Contents Overview

Chapter Overview

Type Index

R&S Addresses





## RMS Voltmeter R&amp;S®URE2, RMS/Peak Voltmeter R&amp;S®URE3

R&amp;S®URE2: DC, 10 Hz to 25 MHz

R&amp;S®URE3: DC, 20 mHz to 30 MHz

R&amp;S®URE2 and R&amp;S®URE3:

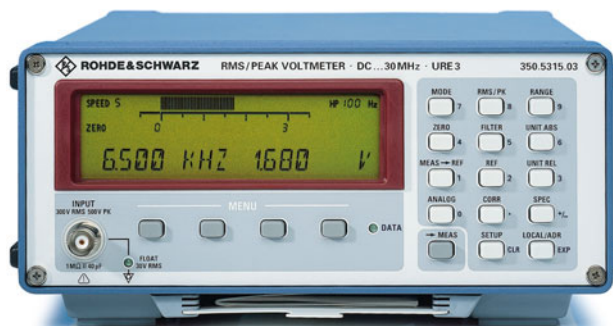
50  $\mu$ V to 300 V (AC); 0 V to 300 V (DC)RMS/Peak Voltmeter  
R&S®URE3

## Brief description

R&S®URE2 is a broadband RMS voltmeter featuring extremely high accuracy and speed. A patented rectifier circuit allows measurement of signals with a crest factor of up to 7 and frequencies of up to 25 MHz. RMS/Peak Voltmeter R&S®URE3 further enhances the range of applications due to its greater frequency range and higher accuracy, built-in frequency counter and additional peak-responding rectifier.

## Fields of application

- ◆ Level measurements in audio range
- ◆ Interference measurements on switch-mode power supplies
- ◆ Measurement of extremely fast dialing signals and detection of simultaneously transmitted supply voltages in radiotelephony
- ◆ Automatic quality control of audio and video tapes
- ◆ High-frequency measurements in digital magnetic storage and optical data storage
- ◆ Peak weighting in video measurements (sync signals)
- ◆ Secondary calibration standard

## Main features

- ◆ True RMS weighting for AC and AC + DC
- ◆ More than 30 measurements/s
- ◆ 4½-digit display and analog display with selectable scale
- ◆ Very high measurement accuracy
- ◆ Highpass and lowpass filters
- ◆ Relative measurement, max./min.
- ◆ Convenient menu-guided operation
- ◆ Use of commercial probes, taking into account their division factor in the displayed result
- ◆ IEC bus (IEEE488)

## Additional features of R&amp;S®URE3

- ◆ Peak-value measurement (positive, negative, peak-to-peak) without tilts and overshoots
- ◆ Fast RMS measurement even of very low-frequency signals
- ◆ Frequency measurement up to 30 MHz
- ◆ Ultrahigh measurement accuracy through automatic frequency response correction
- ◆ In/out option: dual-channel analog output, ready output, trigger input, TTL frequency counter input

## Characteristics

## Measurement accuracy

A patented rectifier circuit with microprocessor-controlled autocalibration makes for the outstanding measurement characteristics of R&S®URE2 and R&S®URE3. In order to further enhance the accuracy, correction factors are determined for each instrument and measurement range and stored in a nonvolatile memory.

A zero function allows noise voltages and the inherent noise to be compensated for, the measurement accuracy being thus increased in particular at low levels.

The measured frequency value is used by R&S®URE3 for an internal frequency response correction. This method increases the accuracy mainly at the higher frequencies. Distortion-free measurement of signals is ensured by:

- ◆ high input impedance
- ◆ low input capacitance
- ◆ highpass and lowpass filters that can be switched in to suppress hum or high-frequency noise voltages



Contents Overview

Chapter Overview

Type Index

R&S Addresses



## Specifications in brief

### RMS Voltmeter R&S®URE2

<b>Measurement functions</b>	RMS value, DC voltage
<b>Range selection</b>	automatic or manual
<b>Input/impedance</b>	BNC connector, floating/1 MΩ    40 pF
<b>Display</b>	LCD, 4½-digit readout, digital and analog in V, W, dBV, dBm, dBμV or dBu; difference, deviation in % or dB and ratio to a reference value
<b>Remote control</b>	to IEC625-2
<b>RMS measurement</b>	
Voltage measurement range	50 mV to 300 V
Ranges	1 mV to 300 V, 10 dB steps
Maximum reading	3800 or 12000 counts
Frequency range AC coupling	10 Hz to 25 MHz
Frequency range AC + DC	DC, 10 Hz to 25 MHz
Selectable lowpass filters	20 kHz, 100 kHz Butterworth (3 dB cutoff freq., 40 dB/decade)
Selectable highpass filters	10 Hz, 100 Hz, 1 kHz (lower meas. limit, AC component in AC + DC)
Time of triggered measurement	32 ms to 1.3 s (selectable; shortest meas. time with 1 kHz highpass only)
Maximum crest factor (S)	7 for nominal range
Measurement uncertainty for non-sinusoidal voltages (spectral components up to 25 MHz)	S <5: <1%, S <7: <3% (for S <3: included in basic error)
<b>DC voltage measurement</b>	general data same as R&S®URE3
<b>DC voltage measurement</b>	see R&S®URE3
<b>General data</b>	see R&S®URE3

### RMS/Peak Voltmeter R&S®URE3

<b>Measurement functions</b>	RMS/peak value, DC voltage, frequency
<b>Range selection</b>	automatic or manual
<b>Input</b>	BNC connector, either floating or grounded, switch-selectable
<b>Input impedance</b>	1 MΩ    40 pF
<b>Display</b>	backlit LCD, 4½-digit level and 5-digit frequency indication, digital and analog in V, W, dBV, dBm, dBmV, dBu or Hz; difference, deviation in % or dB and ratio to a reference value
<b>In/out option</b>	two simultaneous analog outputs (level and frequency), frequency input, trigger input, ready output
<b>Remote control</b>	IEC625-2 (IEEE488.2)
<b>RMS measurement</b>	
Voltage measurement range	50 mV to 300 V
Ranges	1 mV to 300 V, 10 dB steps
Maximum reading	3800 or 12000 counts
Frequency range AC coupling	0.02/10/100/1000 Hz to 30 MHz
Frequency range AC + DC	same as AC coupling, plus DC compon.
Selectable lowpass filters	same as R&S®URE2, plus 1 MHz Bessel
Selectable highpass filters	same as R&S®URE2
Time of triggered measurement	32 ms to 60 s (selectable; shortest meas. time with 1 kHz highpass only)
Maximum crest factor (S)	7 for nominal range
Measurement uncertainty for non-sinusoidal voltages	same as R&S®URE2
<b>Peak measurement</b>	
Voltage measurement range	0.1 mV to 500 V
Ranges and resolution	3 mV to 1000 V, 10 dB steps
Maximum reading	1200 or 3800 counts
Frequency range AC coupling	10/100/1000 Hz to 10 MHz
Frequency range AC + DC	DC, 0.02 Hz to 10 MHz

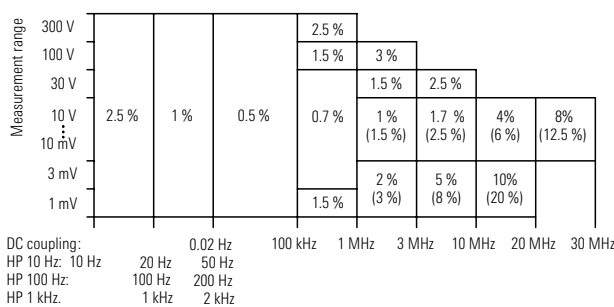

**Accuracy of RMS measurement ( $T_{amb} = 23 \pm 5^\circ\text{C}$ ), plus 10 counts for DC coupling (inherent noise taken into account by zero functions); values in parentheses without frequency response correction (R&S®URE3 only)**

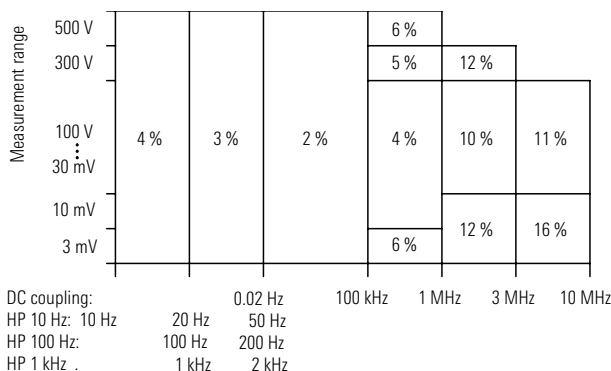

**Accuracy of peak measurement ( $T_{amb} = 23 \pm 5^\circ\text{C}$ ), sinewave signal, R&S®URE3 only)**

Selectable highpass/lowpass filters	same as RMS measurement
Time of triggered measurement	65 ms to 60 s (selectable; shortest measurement time with 1 kHz highpass or DC coupling only)
<b>Frequency measurement</b>	
Frequency range	0.02 Hz to 30 MHz
Display	5 digits
Time of triggered measurement	75 ms to 60 s (selectable)
Sensitivity	min. 10 dB below nominal range
<b>DC voltage measurement</b>	
Voltage measurement range	0 V to ±300 V
Ranges	10 mV to 1000 V, 20 dB steps
Maximum reading	12000 counts
Time of triggered measurement	32 ms to 60 s (selectable)
Accuracy	±(0.1% of rdg + 10 counts)
<b>General data</b>	
Power supply	100/120/240 V ±10%, 230 V -10%/+6%, 47 Hz to 440 Hz (25 VA)
Dimensions (W × H × D)	219 mm × 103 mm × 350 mm
Weight	4.5 kg

## Ordering information

<b>RMS Voltmeter</b>	R&S®URE2	0350.5315.02
<b>RMS/Peak Voltmeter</b>	R&S®URE3	0350.5315.03
<b>Input/Output Option</b>	R&S®URE3-B2	0351.1513.02



Contents Overview

Chapter Overview

Type Index

R&S Addresses





Contents Overview

Chapter Overview

Type Index

R&S Addresses



*"System integration with the aid of software and engineering efforts will be given more emphasis than ever before and the development of powerful and convenient system solutions take on importance."*

## Contents of chapter 8

Designation	Type	Description	Page
The future lies with system		Rohde & Schwarz system philosophy; service for systems	316
Production Test Systems	R&S®TS7110	Contents, test strategies	319
	R&S®TS7100, R&S®TS7180	Shielded RF test fixture	322
	R&S® CompactTSVP	Production Test Systems for Mobile Phones	322
	R&S®E-Line	Open Test Platform	327
Type-Approval Systems for Mobile Radio	R&S®TS895x	Extreme Temperature Tester	329
	R&S®TS8960	Introduction, overview	330
	R&S®TS8965	RF Test System Family for GSM/GPRS/EDGE/3G Mobiles	331
Coverage Measurement Systems	R&S®TS9955H	RF Test System for <i>Bluetooth</i> ® Qualification and Compliance Test Systems	334
	R&S®TS9951, R&S®TS9958	RF Test System for <i>Bluetooth</i> ® Pre-Qualification	335
	R&S®TS9953	Introduction, overview	336
	R&S®TS9954	High-Performance Coverage Measurement System	338
	R&S®UMTS PN-Scanner	Portable Coverage Measurement System (GSM, DAB)	339
	R&S®TSMU	GSM Test Transmitter System	348
EMC Test Systems		Evaluation Software Roseval	350
		Drive test equipment for network planning, design, installation, optimization, quality assurance and service	351
		Radio Network Analyzer	353
	R&S®TS9970	Overview	355
	R&S®TS9975	RF Performance Test System	356
	R&S®TS9976	EMI Test System	358
	R&S®TS9980, TS9981, TS9986,	Emission Test System	359
	R&S®TS998xM	EMS Test Systems	361
	R&S®TS9994	EUT Monitoring System	366
	R&S®TS-EMF	EMS Test System	367
	R&S®EMS-K1	EMS Test System	367
R&S®EMON-K1	Portable System for EMF Measurements	368	
R&S®EMC32, R&S®EMC32E+	EMS Software	370	
	CAN-Bus Monitoring	372	
	EMC Measurement Software, EMI Measurement Software	80, 82	



Contents Overview

Chapter Overview

Type Index

R&S Addresses





Contents Overview

Chapter Overview

Type Index

R&S Addresses



## The future lies with systems

Customer-specific solutions are implemented to an increasing extent by integrating measuring instruments and specially developed devices into overall systems. This is proven by the valuable experience made with turnkey EMC test centers, type-approval test systems for mobile phones of digital radio networks, mobile test systems for coverage measurements and mobile phone production lines.

## System applications

In numerous branches of industry measurements and tests often have to be carried out repeatedly on a series of DUTs, e.g. in:

- ◆ Incoming inspection: component or module tests
- ◆ Production: automatic alignment
- ◆ Quality assurance: testing at the various stages of production and final testing
- ◆ Research&development: series measurements on prototypes
- ◆ Service: long-time measurements (such as temperature) at defined test intervals

The quantity of devices under test required to make investments and software development worthwhile depends on the complexity of the measurement task. The necessary expenditure may even be justified for a few DUTs if a measurement is to be continuously repeated, e.g. at many different frequencies (intermodulation measurement of antenna amplifiers), or if a parameter is to be monitored as a function of time (long-term drift).

## Project handling by Rohde & Schwarz

A high-performance measurement system requires extensive development and design efforts. The choice of the right instruments and components as well as their careful installation make for the high performance and availability of a system.

System design at Rohde&Schwarz ensures full utilization of a large variety of measuring instruments of advanced technology and highest precision both of Rohde&Schwarz and other make. System responsibility lies always with Rohde&Schwarz, irrespective of the origin of the measuring equipment and individual system components.

Rohde&Schwarz has experienced and optimally trained staff to implement a project from initial planning through to the operational system.

## Our range of test systems

- ◆ Production test systems, board testers
- ◆ Type-approval test systems for mobile phones
- ◆ Coverage measurement systems for all modern radio networks
- ◆ EMC test systems and test centers

### Production test systems, board testers – a strong concept

A development and production chain is only as strong as its weakest links which used to be highly complex measurement systems and time-consuming final testing. Market launch of the products was thus held up. Today, production test systems and type-approval systems from Rohde&Schwarz can be used wherever electronic equipment is produced. Efficient solutions in this field range from precompliance test equipment through to complete production lines.



Contents Overview

Chapter Overview

Type Index

R&S Addresses



[Contents Overview](#)[Chapter Overview](#)[Type Index](#)[R&S Addresses](#)

The unique modular hardware and software concept of Rohde&Schwarz allows a large variety of test combinations with respect to alignment, RF test, optical check, board test, etc.

Our production test systems are tailored to the needs of the customers and provide overall solutions: measurements with DUT adaptation also in RF range via test prods; with conveyor belts; networking within user-specific computer network; logistics; consulting and advice in the selection of suitable tests for optimization of measurement times and test depth.

#### **Type-approval test systems for mobile phones of analog and digital radio networks**

Test systems from Rohde&Schwarz, especially for type-approval testing, are at the leading edge in their field. Our customers are benefiting from this high innovation potential. Specialists at Rohde&Schwarz have implemented well in-time the latest requirements for type-approval measurements in the appropriate test systems and were able to use ultramodern measuring equipment off our production. This synergy of available equipment and new system applications brings about optimum results. Thus it is for instance possible to achieve maximum test depth while ensuring the highest degree of ergonomics and operational reliability. And another great advantage is self-calibration. This means a whole bundle of benefits which the customer can utilize to make his products fit both for the future and present-day market.

#### **Coverage measurement systems for all modern radio networks**

Test systems from Rohde&Schwarz are not only used where electronics is produced but also where it is made to "work": in mobile radio networks for instance. Our range of mobile coverage measurement systems ensures full monitoring of analog and digital radio networks as well as smooth and best possible operation.

#### **EMC test systems and test centers**

Rohde&Schwarz supplies complete EMC test systems covering all aspects of this complex field. The manufacturer need no longer combine individual instruments – systems will do it. Whole EMC test chambers? No problem for Rohde&Schwarz: after handing over the turnkey system, all your staff trained by us has to do is to switch on the DUT and the test will be carried out fully automatically. This is to the benefit of test houses as well as manufacturers performing comprehensive EMI and EMS measurements themselves. The test systems from Rohde&Schwarz check for full compliance with all relevant standards.

#### **Future-oriented design**

Measurement and test systems from Rohde&Schwarz feature extremely flexible hardware and software concepts allowing adaptation to modified requirements any time.

#### **Support**

Test stations from Rohde&Schwarz are powerful instruments for increasing productivity in automated production. Rohde&Schwarz products include a complete service package, which allows the full performance of the system to be utilized from the very first day. This package includes training, application support, maintenance, fixture design, 24-hours spare parts service and a telephone hotline.

#### **References**

Measurement and test systems from Rohde&Schwarz are used to success all over the world: tailored to the needs of the customers, the test systems can be found at renowned industrial companies, test houses and government institutes – the impressive list of references can be supplied on request.

[Contents Overview](#)[Chapter Overview](#)[Type Index](#)[R&S Addresses](#)



## Service for systems

### First-hand service

Rohde&Schwarz systems combine the latest achievements in hardware and software with the knowhow and experience gained over many decades. According to the Rohde&Schwarz system philosophy, the high level of competence does not stop with system development but is maintained during the operational life of the systems in terms of the services offered.

Hotline support, continuous updating of system software, fast replacement and repair of equipment and modules in case of a fault are essential prerequisites for high availability of an operational system.

Rohde&Schwarz offers complete packages and solutions for servicing the systems. The service concept is of modular structure and consists of unit blocks providing a whole series of services for hardware and software.

### Services available

#### During warranty period

- ◆ Enhanced warranty service
  - Problem report service
  - Hotline service
  - Access to a pool of spare modules
- ◆ Calibration service

#### After warranty period

- ◆ After warranty service
  - Problem report service
  - Hotline service
  - Access to a pool of spare modules
- ◆ Software service
- ◆ Calibration service

### Service products

#### Enhanced warranty service

The enhanced warranty service supplements the standard warranty services of Rohde&Schwarz to satisfy already during the warranty period the high demands placed on system availability and offers a service time of eight hours and defined response time.

- ◆ Database-supported information system with direct customer access
- ◆ Hotline service
- ◆ Access to a pool of spare modules
- ◆ On-site repair, if necessary
- ◆ Escalation procedure

#### After warranty service

The after warranty service contains all the unit blocks of the enhanced warranty service plus the following:

- ◆ Repair of faults
- ◆ Supply of software updates

#### Calibration service

The calibration service assures you that the parameters of your system will be checked at regular intervals and corrected if necessary.

- ◆ Calibration by an accredited calibration laboratory in line with EN ISO/IEC 17025
  - ◆ Calibration at specified calibration intervals in line with DIN EN ISO 9001
  - ◆ Traceability of calibration to national or international standards
  - ◆ Calibration reports and certificates
  - ◆ On-site calibration possible

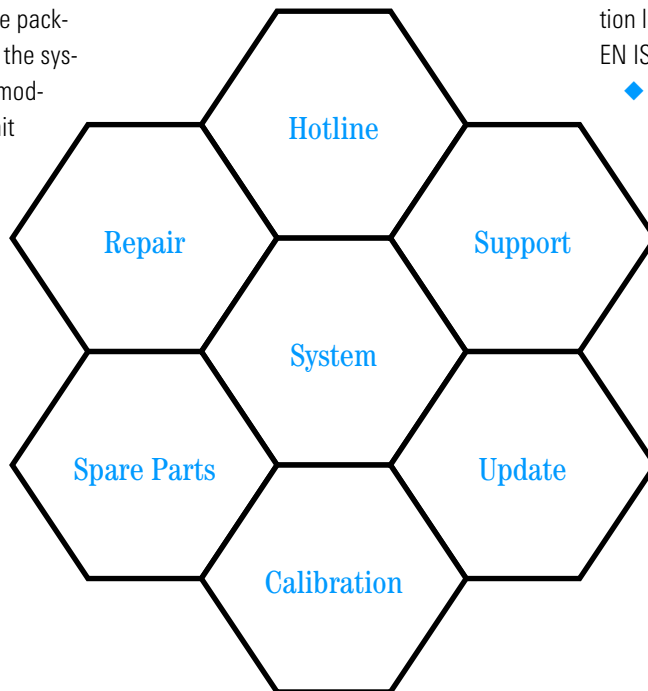



Contents Overview

Chapter Overview

Type Index

R&S Addresses



## Production Test Systems – Contents

Designation	Type	Description	Page
Production Test Systems	R&S®TS 7110 R&S®TS 7100 R&S®TS 7180	Scalable solutions from low-cost standard system to turnkey production system	341
Open Test Platform	R&S® CompactTSVP	Automotive & Communication Test Solutions	327
Extreme Temperature Tester	R&S®E-Line	Temperature tests on wireless components in a shielded environment	329

### Quality is measurable and testable

#### Quality management

Quality management is one of the central aspects of modern electronics production. Whatever the size of the company, the quality of the products depends on the electronic components functioning perfectly. The introduction of lean production methods has placed new and greater demands on automatic testing techniques.

#### Economy

#### Product quality, product liability

Today, excellent product quality is not only important in giving the edge in international competition but also saves cost. Our test systems help to eliminate defects early in production, thus preventing the high costs involved in the removal of defects in the final stages of production or after delivery to the customer.

In-depth testing is possible due to the wide range of precise measuring facilities provided by the workstations and test stations from Rohde&Schwarz, so faults can be detected early in production and their cause removed immediately.

### Start small – upgrade later

Test stations from Rohde&Schwarz are more than simply autonomous testers – they have specifically been designed for integration into development, production and service. Fixtures and programs can be exchanged directly between the testers. The systems can thus be used to maximum effect: all test stations can be utilized optimally at all times; if the unit under test is large, subsequent upgrading to larger systems is no problem; fixtures can be adopted for servicing at any time.

Due to the modular design of the Rohde&Schwarz test stations, investment decisions can be made to satisfy the requirements of today, and, at the same time, options be left open for expanding capacity or testing new products as well as for incorporating future test strategies or supplementary test facilities at a later date. Investments, costs of adaptation and running costs of the test stations can be optimized for different products and production methods.

#### Low follow-up costs

Budget-priced fixture sets can be offered thanks to a standardized fixture interface. Thus costs of adaptation are low, which is of major importance for products manufactured in small quantities only. The reliable and easy-to-service concept ensures

high availability, so running costs are reduced to a minimum.

### Electrical in-circuit test

#### Strategy

The electrical in-circuit test for a board checks all connections and the individual components independent of their environment.

This tried-and-tested method is an extremely reliable means of detecting and diagnosing the majority of typical manufacturing defects, such as shorts, opens, soldering and insertion defects. The influence of neighbouring components can be eliminated to a large extent, and a high degree of precision achieved, by means of 2-, 3-, 4- or 6-wire measurements, guarding and in-phase quadrature measurements. The measured values are stabilized, even under unfavourable conditions, by averaging and autodelay technique. The depth of testing is far superior to that of conventional prescreeners.

#### The electrical in-circuit test checks the following:

- ◆ Contact
- ◆ Shorts and opens
- ◆ Resistances, inductances and capacitances
- ◆ Impedances by magnitude and phase
- ◆ Diodes, Zener diodes, LEDs
- ◆ Transistors
- ◆ Multipole components such as potentiometers, relays, operational amplifiers, optocouplers



Contents Overview

Chapter Overview

Type Index

R&S Addresses



[Contents Overview](#)[Chapter Overview](#)[Type Index](#)[R&S Addresses](#)

## Production Test Systems – Test strategies

### Analog functional test

#### Strategy

Defined analog input signals are applied to the unit under test and the output signals are measured. This test checks all functions of the UUT and the interaction of its components.

#### Procedure

Rohde&Schwarz test stations provide all standard signals and measurement functions via appropriate stimulus and measurement modules. The signals are accessible either via very short paths at special fixed pins, or via the signal bus and the switch module at any pin.

The measurement equipment can be extended by adding CompactPXI and PXI modules.

The modules are equipped to trigger and synchronize (PXI trigger) with each other, the UUT, or external instruments. External IEC/IEEE-bus instruments can be connected to the test stations.

### Digital functional test

#### Strategy

The digital functional test checks all functions of a digital circuit as close as possible to operating conditions.

It covers all technologies from SSI to VLSI, microprocessors, ASICs and SMDs. Digital input patterns are applied, and the output signals are measured and compared with the reference patterns.

Due to the varying complexity – from simple to complex VLSI boards – and the widely differing timing requirements, the user is given the opportunity of choosing the most economical of the various testing procedures available. The type of fixture can thus also be varied via the connectors of the UUT, the bed-of-nails (including 2-stage fixture), or probe.

#### Procedure

Dynamic functional test: Digital patterns (vectors) are applied to the connections of the UUT in realtime mode and with a high clock rate; the response is then measured and compared with the reference values.

Static functional test: Digital patterns are created and analyzed via computer. The result may lead to branching. Timing is not accurately determined.

Interface test: Optimized tests are available for different interfaces (RS-232-C, LAN, SPI).

### Combinational test

The combinational test unifies various test strategies in a single tester with one program and one fixture, eliminating the handling time for separate testers. The user can select a combination which is specially tailored to his needs. This concept allows the peculiarities of customer-specific requirements to be taken into account, for instance the production environment, production quality, test strategy, complexity of UUT and special factors such as stipulated or impermissible test procedures, inaccessible nodes or varnished boards.

[Contents Overview](#)[Chapter Overview](#)[Type Index](#)[R&S Addresses](#)





Contents Overview

Chapter Overview

Type Index

R&S Addresses



## Mobile radio – a dynamic market

**The mobile radio market is undergoing dynamic changes and characterized by rapidly increasing production volumes, extremely short product cycles and a variety of mobile radio standards**

Special design tools and chip sets today simplify mobile radio development, which has resulted in many new manufacturers entering this market and offering attractively priced products of their own. This leads to increasingly fierce competition.

### Important developments on the mobile phone market

- ◆ Reduction of time to volume
- ◆ Reduction of production costs
- ◆ Re-usable test solutions for new products and new mobile radio standards
- ◆ Outsourcing to contract manufacturers
- ◆ New mobile radio manufacturers
- ◆ Use of reference designs from different chip set manufacturers
- ◆ Large local markets, e.g. China
- ◆ Test solutions from global manufacturers used as standard worldwide
- ◆ Global projects involving development teams and production plants around the world

### Demands on production test solutions

- ◆ Minimization of costs per mobile radio unit, i.e. high throughput
- ◆ Standardized, easily adaptable solutions
- ◆ Production at any location around the world
- ◆ Easy integration of a company's own core competences
- ◆ Local support on a global scale



- ◆ Continuous development and upgrading to include new mobile radio standards
- ◆ Constant optimization, updating and further development of test platform
- ◆ Ready-to-use solutions for different reference designs
- ◆ Global project management

### From the standard system to the turnkey solution

Our regional support and system integration centers will be glad to assist you in selecting and configuring a system that best suits your application and also integrate the system into your production line. Rohde&Schwarz offers you a complete spectrum of solutions and services for mobile phone production testing, thus minimizing time-to-volume and test costs while providing comprehensive test coverage.

Because of our many years of experience in mobile phone production testing – including with a variety of reference designs from chip set manufacturers – Rohde&Schwarz can offer optimized solutions that cover the entire spectrum from adjustment up to final testing.

### To keep production running

Our regional system support and integration centers also provide system maintenance, repair and calibration as well as training of operating personnel. Maintenance contracts can be tailored to your specific requirements. Our experts assist you in optimizing new processes and also follow you when your production is relocated.



Contents Overview

Chapter Overview

Type Index

R&S Addresses





Contents Overview

Chapter Overview

Type Index

R&S Addresses



## Shielded RF Test Fixture R&S®TS7110



**Test fixture for modules and devices with a radio interface**

### Brief description

The R&S®TS7110 is a shielded test fixture for devices under test (DUTs) that have a radio interface, e.g. mobile phones, personal digital assistants (PDAs), remote keyless entry, cordless phones, and other small devices. The DUTs can operate on the basis of diverse radio standards such as GSM, WCDMA (UMTS), Bluetooth™\*, WLAN or Home RF.

The test fixture was designed for the R&S®TS7100 (cPCI) and R&S®TS7180 (PC-based) production test systems. However, owing to its standardized USB interface and modular design, it can also be used in combination with other test systems. A DLL interface is provided on the software end to control the individual components. The test fixture is primarily used in production, but also in service, repair and quality assurance.

### Main features

- ◆ Comprehensive concept for function tests (board and final tests as well user interface testing)
- ◆ RF- and audio-compliant setup of the test chamber
- ◆ Modular design
- ◆ Exchangeability of the DUT mount
- ◆ Upgradeability for new product versions
- ◆ Control via standardized USB interface
- ◆ Easy manual operation due to pneumatic support
- ◆ Status displays for user information
- ◆ Separate operating program for debugging or manual operation



*The Shielded RF Test Fixture R&S®TS7110 with customer-specific configuration*

### Design and function

The semi-automatic Shielded RF Test Fixture R&S®TS7110 consists of a base and a hinged top with pneumatic support for easier opening and closing. The top contains a universal mount for the hold-down pieces that are used to position DUTs as well as other test fixtures for tasks that need to be carried out from the top of the DUT.

The base integrates the lower part of the RF chamber with the swapout unit including DUT mount. The test system interface is also housed here, containing the fixture control as well as additional built-ins, signal conditioning and level converters for communicating with the DUT. Mechanically standardized interfaces make it easy to exchange the swapout unit for testing other devices or models with similar testing tasks.

### Shielded test chamber

When RF modules are tested, external sources of interference (nearby base stations, adjacent test systems, etc) must always be taken into account.

To sufficiently suppress these signals, the test fixture is shielded against high-frequency interference. Pneumatic lines are routed through special wall feedthroughs, electrical signals through RF feedthroughs or sub-D connectors with filters. RF and audio absorbers can also be installed to prevent interference due to reflections in the test fixture.

Universal antenna couplers are provided for testing wireless interfaces in the RF range. They are available for all common frequency bands as used, for example, with 2G and 3G mobile phones, network adapters, WLAN, or Bluetooth.



Contents Overview

Chapter Overview

Type Index

R&S Addresses



## Shielded RF Test Fixture R&S®TS7110

### Applications

The fully modular concept of the RF test fixture allows a wide variety of components for almost any task such as the following to be integrated:

- ◆ Electrical testing of printed board assemblies on one or both sides
- ◆ RF tests via antenna couplers that can be integrated
- ◆ Audio tests using the audio set
- ◆ Keyboard tests with pneumatic fingers
- ◆ Tests of displays with CCD cameras
- ◆ Tests of built-in cameras with illuminated test patterns
- ◆ Testing of interfaces and components such as memory cards, etc

The elevated cover provides sufficient room for integrating CCD cameras.

Making a significant number of project-specific adaptations is always necessary since manufacturers have highly diverse test requirements and the layouts of DUTs can differ widely from one to the next.

This affects not only the DUT mount but also the position and scope of mechanical, electrical and optical components.

### Control

The test fixture control is integrated completely in the generic test software library (GTSL) by Rohde & Schwarz. For more information, refer to the data sheets for the Production Test Platforms

R&S®TS7100 (PD 0757.5737) and R&S®TS7180 (PD 0757.7469).

The test fixture can also be controlled via a DLL and the operator panel.

Either a Rohde & Schwarz integration center, an authorized systems house or the individual user can implement this customer-specific application. The modular concept allows users to combine or modify components that have been adapted to operate together.

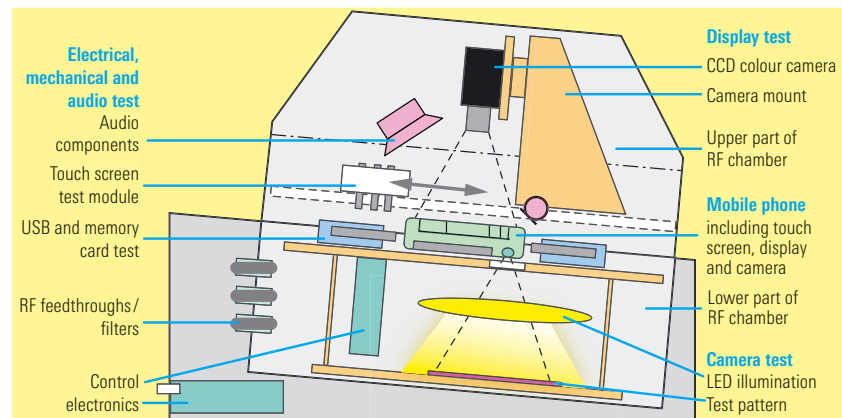

**Setup of the test fixture for final tests including display and camera tests**

**Operator panel and online help**



Contents Overview

Chapter Overview

Type Index

R&S Addresses



## Shielded RF Test Fixture R&S®TS7110

### Specifications

#### Basic unit

Dimensions	
Test fixture (W x D)	41 cm x 60 cm
Height (closed)	36 cm, with camera 44 cm
Height (open)	60 cm
DUT max. (W x D)	13 cm x 22 cm
Height (with acoustic installation kit)	5 cm
Height (w/o acoustic installation kit)	14 cm
Weight	
Without options	14 kg
With typical options (absorber, fixture interface card, acoustic installation kit, antenna)	19 kg
Temperature ranges	
Operating temperature range	+10°C to +40°C
Storage temperature range	-20°C to +60°C
Relative humidity	
In operation	90% r.h. at +10°C to +30°C
In storage	75% r.h. at +30°C to +40°C 90% r.h. at +60°C
Required resources	
	compressed-air connection, AC supply voltage (see Fixture interface card)
Connectors	
In the test fixture housing (base unit)	
Pneumatics: hose diameter	6 mm
Compressed air	0.4 Mpa to 0.7 Mpa filtered 5 µm, oiled/non-oiled for max. 6 magnetic valves
Pneumatics block	
Line feedthrough (W x H)	4.5 cm x 3 cm
Connection board (W x H)	25 cm x 10.5 cm (usable)
Ground connection	thread bolt M5 x 15 and pushbutton connection
Connection board in the RF housing	
RF	2x SMA – SMA connector
Pneumatics	8x Schott screw connection for hose connection (3 mm internal diameter)
Audio	9-contact, sub-D, filtered
Data	15-contact, sub-D, filtered
Power + unused connectors	25-contact, sub-D, filtered
RF shielding	
	without absorber    with absorber. (option)
450 MHz to 600 MHz	>65 dB    >75 dB
800 MHz to 1000 MHz	>60 dB    >75 dB
1700 MHz to 2000 MHz	>55 dB    >65 dB
2000 MHz to 2500 MHz	>45 dB    >65 dB
AF shielding	
200 Hz to 400 Hz	>12 dB
400 Hz to 1000 Hz	>16 dB
1000 Hz to 4000 Hz	>23 dB

#### Fixture interface card (optional)

Interface to test system	
Power supply (external power supply unit)	$V_{in} = 100 \text{ V AC to } 240 \text{ V AC, } 1.5 \text{ A, } 50 \text{ Hz to } 60 \text{ Hz, } V_{out} = 24 \text{ V DC, } 3 \text{ A}$ via R&S®TS-PRL1 from R&S®TS7000 series
Interface to test system	
Hardware	1x USB or R&S®TS-PRL1 (R&S®TS7100) interface board on exterior housing 2x BNC for audio 1x sub-D each for DUT power supply and control (RS-232-C) GTSL (R&S®TS7100, R&S®TS7180)
Software	
Internal interfaces to fixture control and DUT	
Digital inputs	4 or 8 high active, max. 24 V DC, $V > 4 \text{ V high}$
Digital outputs	8x open collector, max. 300 mA, 30 V
Audio input	1:2 multiplexer
Amplifier to artificial mouth	-70 dB to +5 dB, $V_{in} \text{ max. } 5 \text{ V (} V_{rms} \text{), } P_{out} \text{ max. } 2 \text{ W into } 8 \Omega$
Amplifier to DUT	-34 dB to 0 dB $V_{in} \text{ max. } 5 \text{ V (} V_{rms} \text{), } V_{out} \text{ max. } 5 \text{ V (} V_{rms} \text{)}$
Audio output	2 microphone amplifiers from artificial ear or buzzer
Amplifier from DUT	3:1 multiplexer 0 dB to +40 dB, 5 V bias differential input -12 dB to +28 dB, $V_{in} \text{ max. } 5 \text{ V (} V_{rms} \text{), } V_{out} \text{ max. } 5 \text{ V (} V_{rms} \text{)}$
Relays	8 or 12 SPST, max. 500 mA, 30 V, can be connected to DMM from DUT power supply
DUT control RS-232-C	via level converter, max. 250 kbps Rx/D, Tx/D, RTS, CTS, GND, voltage adjustable between 3.0 V and 3.6 V
USB	full speed, high speed (special filters/fiber optic cables required)

#### Antenna coupler (optional)

Type 1	e.g. GSM, WCDMA
Frequency ranges	770 MHz to 1000 MHz 1700 MHz to 2200 MHz
Coupling factors	8 dB to 25 dB, depending on frequency and DUT
Connector	SMA
Type 2	e.g. Bluetooth
Frequency ranges	2400 MHz to 2550 MHz 1700 MHz to 2200 MHz
Coupling factors	20 dB to 30 dB, depending on frequency and DUT
Connector	SMA
Type 3	e.g. WLAN
Frequencies	2.4 GHz 5.2 GHz 5.75 GHz
Connector	SMA

#### Acoustic installation kit (optional)

Components	
Artificial mouth	
Frequency range	250 Hz to 4 kHz
Artificial ear	
Frequency range	200 Hz to 4 kHz



Contents Overview

Chapter Overview

Type Index

R&S Addresses





Contents Overview

Chapter Overview

Type Index

R&S Addresses



## Shielded RF Test Fixture R&S®TS7110

### Ordering information

Example packages *)	Type, order number	Package A Basic model	Package B Automatic module test	Package C Automatic final test I	Package D Automatic final test II	WU
<b>Application</b>		Test of devices or modules that require an RF chamber – Manual connection of the DUT  e.g. R&D, service**)	Automatic test of electronic modules with – Automatic contact  e.g. for production**)	Automatic test of devices with – Automatic contact – Radio interface – Audio interface  e.g. for production**)	Automatic test of devices with – Automatic contact – Radio interface – Audio interface – Display (colour)  e.g. for production**)	R&S®TS-F1A
<b>Included components</b>		– Control – Universal exchangeable plate  <b>Option packages</b> – A: Acoustic set Image processing components ***): – B: Monochrome – C: Colour	– Control – Exchangeable plate kit – Pneumatic set for swapout unit and hold-down piece – Hold-down plate  <b>Option packages</b> – A: Acoustic set Image processing components ***): – B: Monochrome – C: Colour	– Control – Exchangeable plate kit – Acoustic set – Antenna coupler – Pneumatic set for swapout unit and hold-down piece – Hold-down plate – Absorber  <b>Option packages</b> Image processing components ***): – B: Monochrome – C: Colour	– Control – Exchangeable plate kit – Acoustic set – Antenna coupler – Pneumatic set for swapout unit and hold-down piece – Elevated cover – Hold-down plate – Camera mount – Cable+filter for colour camera***) – Keyboard test – Absorber	X * R&S®TS-7110-C1 = working units for installing and testing the options in the R&S®TS-F1A
<b>Base unit</b> Housing with – Basic pneumatic equipment such as pressure regulator and closing device – Status display RF chamber with – Pneumatic feedthroughs and 3 filter connectors – Mounts for swapout units below and hold-down plate above	<b>R&amp;S®TS-F1A</b> 1152.6007.02					4
<b>Control Card for R&amp;S®TS-F1A</b> – RS-232-C, R&S TSVP interface – USB interface (1.1 and 2.0, slow speed) – Audio interface	<b>R&amp;S®TS-F111</b> 1152.6307.02	✓	✓	✓	✓	3
<b>External 24 V AC Power Supply</b>	<b>R&amp;S®TS-PS24</b> 1152.6459.02	✓	✓	✓	✓	–
<b>Cable Set for Connection to R&amp;S®TS7180</b>	<b>R&amp;S®TS-F1C1</b> 1152.4904.02	☺	☺	☺	☺	–
<b>Absorber Set for Base Unit R&amp;S®TS-F1A</b>	<b>R&amp;S®TS-F1B</b> 1152.6107.02	☺	☺	✓	✓	4
<b>Swapout Unit (kit)</b> with 96-contact VG connector (female) or <b>Mounted Swapout Unit</b> + self-adhesive pad	<b>R&amp;S®TS-F1P1</b> 1152.6207.02	–	✓	✓	✓	**)
	<b>R&amp;S®TS-F1P1UN</b> 1165.1673.02	✓	–	–	–	1
<b>Pneumatic Set, 4x</b> Valves, hoses, couplers+hardware or	<b>R&amp;S®TS-F1PNE4</b> 1165.1680.02	☺	✓	✓	☺	**)
<b>Pneumatic Set, 8x</b> (2x R&S®TS-F1PNE4, 4 connecting pieces)	<b>R&amp;S®TS-F1PNE8</b> 1165.1696.02	☺	☺	☺	✓	**)



Contents Overview

Chapter Overview

Type Index

R&S Addresses



## Shielded RF Test Fixture R&S®TS7110

Example packages *)	Type, order number	Package A Basic model	Package B Automatic module test	Package C Automatic final test I	Package D Automatic final test II	WU
<b>Hold-Down Plate</b> for customer-specific configuration or	<b>R&amp;S®TS-F1P2</b> 1165.1709.02	☺	✓	✓	✓	**)
<b>Assembly Set</b> for acoustic set und DUT hold-down piece	<b>R&amp;S®TS-F1MA1</b> 1165.1715.02	☺ (for option package A/B/C)	–	–	–	1
<b>GSM Antenna Coupler</b>	<b>R&amp;S®TS-F1N1</b> 1152.6259.02	☺	☺	✓	✓	1
<b>Bluetooth Antenna</b> (without assembly material)	<b>CMU-Z12</b> 1150.1043.02	☺	☺	☺	☺	**)
<b>WLAN Antenna</b> (without assembly material)	<b>TW-614/S</b> 1153.4008.00	☺	☺	☺	☺	**)
<b>Acoustic Set</b>	<b>R&amp;S®TS-F1A1</b> 1152.6407.02	J (for option package A)	J (for option package A)	✓	✓	1
<b>Video Lowpass Filter</b>	<b>R&amp;S®TS-FI-LPV</b> 1165.1721.02	B: ☺, C: ☺☺ (for option package B/C)	B: ☺, C: ☺☺ (zu Optionspaket B/C)	B: ☺, C: ☺☺ (for option package B/C)	✓✓	1
<b>Cable Set</b> for BW camera (BAS)	<b>R&amp;S®TS-FC-BAS</b> 1165.1738.02	☺ (for option package B)	☺ (for option package B)	☺ (for option package B)	–	1
<b>Cable Set</b> for colour camera (S video, Y/C)	<b>R&amp;S®TS-FC-YC</b> 1165.1521.02	☺ (for option package C)	☺ (for option package C)	☺ (for option package C)	✓	1
<b>Camera Mount</b> for Hold-Down Plate R&S®TS F1P2	<b>R&amp;S®TS-F1P2MC</b> 1145.6486.12	–	☺ (for option package B/C)	☺ (for option package B/C)	✓	1
<b>Camera Mount</b> for Assembly Set R&S®TS F1MA1	<b>R&amp;S®TS-F1MC1</b> 1145.6486.02	☺ (for option package B/C)	–	–	–	1
<b>Cover</b> for camera installation	<b>R&amp;S®TS-FCBV</b> 1145.6470.02	☺ (for option package B/C)	☺ (for option package B/C)	☺ (for option package B/C)	✓	1
<b>Absorber Set</b> for R&S TS-FCBV	<b>R&amp;S®TS-F1D</b> 1165.1444.02	☺ (for option package B/C)	☺ (for option package B/C)	☺ (for option package B/C)	✓	2
<b>Assembly and Test</b> of the Shielded RF Test Fixture R&S®TS7110 (1x R&S®TS-7110C1 = 1 working unit)	<b>R&amp;S®TS-7110C1</b> 1156.3054.10	Example of package A: requires 8x R&S®TS-7110C1	Example of package B: requires 8x R&S®TS-7110C1	Example of package C: requires 14x R&S®TS-7110C1	Example of package D: requires 20x R&S®TS-7110C1	
<b>Adaptations</b> By the user or as a project together with the Rohde & Schwarz Production Test Department						
<b>Modification of Base Unit R&amp;S®TS-F1A</b>	<b>R&amp;S®TS-F1AMOD</b> 1165.1480.xx					
<b>Modification of swapout unit +hold-down piece</b>	<b>R&amp;S®TS-F1ADAB</b> 1145.6286.xx					

### Examples of typical configurations

- 1) Other configurations on request.
- 2) Customer-specific adaptation by the user or implementation via Rohde & Schwarz.
- 3) Camera, frame grabber and cable for frame grabber not included.

We reserve the right to make design changes corresponding to advances in technology.

For further information, visit [www.hf-adapter.rohde-schwarz.com](http://www.hf-adapter.rohde-schwarz.com).



Contents Overview

Chapter Overview

Type Index

R&S Addresses



## Open Test Platform R&S® CompactTSVP



### Automotive & Communication

#### Test Solutions

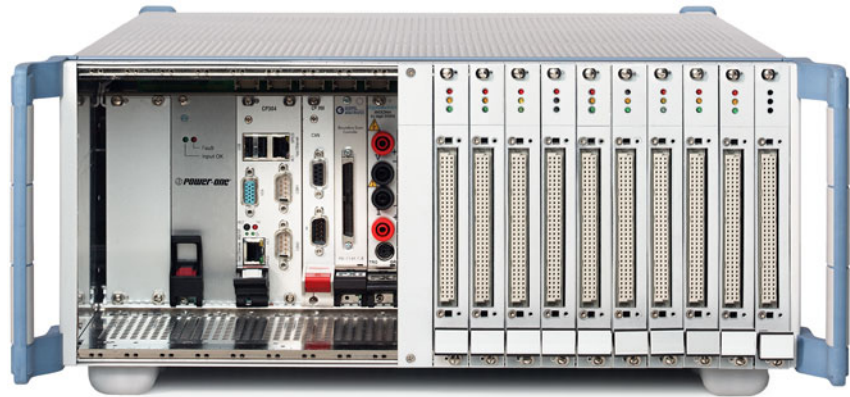

#### Brief description

The R&S®TSVP (Test System Versatile Platform) technology represents a whole family of products developed for high-performance ATE applications. The chassis comprises a mechanical frame, digital backplanes and bridges (if applicable), analog backplane, mains switching and filtering, power supply and diagnostic extensions.

#### Main features

- ◆ CompactPCI backplane conforming to PICMG 2.0 Rev. 3.0 specification
- ◆ Rear I/O support for easy system cabling (IEEE 1101.11-1998)
- ◆ Supports two 47-pin connector redundant power supplies
- ◆ Front plug-in power supply unit for easy maintenance
- ◆ Supports 14 peripheral slots for versatile instrumentation
- ◆ Sophisticated analog measurement bus subsystem
- ◆ Common diagnostic features for all instrumentation modules
- ◆ Internal analog and trigger bus providing PXI functionalities
- ◆ Easy expandable ATE switching
- ◆ Cost-effective peripheral control for switching units via CAN

- ◆ Based on industrial standards
- ◆ Test and measurement modules with floating inputs available
- ◆ Comprehensive driver support including soft front panels

#### Test and Measurement Platform R&S® CompactTSVP

The industrial chassis for modular instrumentation includes one power supply and is prepared to accommodate an additional power supply, which allows parallel operation or DUT-specific supply. The new generation system platform is based on industrial standards and extended by the high-accuracy R&S®TSVP analog bus.

The CompactPCI/PXI backplane provides 14 peripheral slots with additional CAN serial control lines. An external CAN port for the R&S®PowerTSVP control is included.

#### Switching Application Platform R&S® PowerTSVP

The R&S®PowerTSVP is an industrial chassis frame for complex and modular switching applications, a new generation system platform based on industrial standards and extended by the high-accuracy R&S®TSVP analog bus.

It is controlled by the R&S®TS-PCA3 CompactTSVP or various CAN interfaces available for PCs and notebooks.

#### R&S® CompactTSVP Measurement Modules

You can choose from various modules suitable for industrial use in research, development and production. Designed for ATE applications (automated test equipment), the modules provide common features, such as analog bus access for seamless signal routing, diagnostics, soft front panels and high-performance driver software.

#### Analog Source and Measurement Module R&S®TS-PSAM

The R&S®TS-PSAM module contains a discharge circuit, a floating, programmable source and a fast measurement unit. DUT signals can be retrieved from the analog bus of the R&S®CompactTSVP by means of relays. The trigger logic of the measurement unit is linked to the PXI trigger lines. Two 4-channel relay multiplexers are available in addition.



Contents Overview

Chapter Overview

Type Index

R&S Addresses





Contents Overview

Chapter Overview

Type Index

R&S Addresses



## Open Test Platform R&S® CompactTSVP

### In-Circuit Test (ICT) Extension Module R&S® TS-PICT

The ICT extension module comprises an AC stimulus and a special current measurement unit for guarded impedance measurements in conjunction with the R&S® TS-PSAM module.

### Digital Functional Test Module R&S® TS-PDFT

The R&S® TS-PDFT is a digital function test module with a high number of dynamic digital I/O channels as well as automotive communication interfaces. The innovative technology and versatile functionality provide excellent suitability for automotive and high-performance T&M applications.

### Arbitrary Waveform and Function Generator Module R&S® TS-PFG

The R&S® TS-PFG is a two-channel, floating and arbitrary waveform generator with a CompactPCI interface. Its innovative technology and high functionality makes it ideal for automotive applications. The module is used wherever one-channel or multichannel analog output signals are to be stimulated.

### Analyzer and Data Acquisition Module R&S® TS-PAM

The R&S® TS-PAM is a two-channel simultaneous waveform analyzer with CompactPCI interface.

Both conversion paths can be operated with a 4-channel multiplexer. The programmable measurement range and scan operation permit a variety of signal configurations to be measured. Comprehensive trigger capabilities and differential inputs enable flexible data acquisition particularly in R&D labs, quality assurance and product re-verification in production.

### R&S® CompactTSVP and R&S® PowerTSVP Switching Modules

Designed for the CAN bus as a cost-effective control interface, the R&S® TSVP switching modules provide signal interconnection from the DUTs to the modular instrumentation units. The modules provide common features such as analog bus access, diagnostics, soft front panels and high-performance driver software.

### Switching Matrix Module R&S® TS-PMB

The matrix module B allows test points or test devices to be interconnected either locally or via the analog measurement bus. The module can be used in the R&S® CompactTSVP and the R&S® PowerTSVP. The built-in self-test capability makes it possible to check the module within the system.

### Power Switching Module R&S® TS-PSM1

The R&S® TS-PSM1 is a power switching module controlled by the CAN bus. Its innovative technology and versatile functionality make it ideal for automotive and high current switching applications in power management and test load paradigms. For measuring high currents, shunts are integrated on-board. It is used wherever high voltage or currents have to be switched or distributed.

## Ordering information

### Open Test Platform R&S® CompactTSVP and R&S® PowerTSVP

Chassis		
Test and Measurement Platform	R&S® TS-PCA3	1152.2518.02
Switching Application Platform	R&S® TS-PWA3	1157.8043.02
Modules		
Analog Source and Measurement Module	R&S® TS-PSAM <sup>1)</sup>	1142.9503.02
In-Circuit Test (ICT) Extension Module	R&S® TS-PICT <sup>1)</sup>	1158.0000.02
Digital Functional Test Module	R&S® TS-PDFT	1143.0080.02
Arbitrary Waveform and Function Generator Module	R&S® TS-PFG <sup>1)</sup>	1158.0052.02
Analyzer and Data Acquisition Module	R&S® TS-PAM <sup>1)</sup>	1158.0100.02
Switching Matrix Module	R&S® TS-PMB	1143.0039.02
Power Switching Module	R&S® TS-PSM1	1143.0139.02

<sup>1)</sup> Including R&S® TS-PDC isolated DC-supply module.



Contents Overview

Chapter Overview

Type Index

R&S Addresses







Contents Overview

Chapter Overview

Type Index

R&S Addresses



## Extreme Temperature Tester R&S®E-Line

**Temperature tests on wireless components in a shielded environment**

### Brief description

The Extreme Temperature Tester R&S®E-Line is a measurement environment for wireless RF devices (e.g. mobile phones, *Bluetooth* devices, and remote keyless entry systems).

The R&S®E-Line combines a shielded environment with a temperature-controlled chamber. Used as a test sequencer, the R&S®TSVP allows several devices to be measured in the same test run.

The R&S®E-Line is software-controlled and handles all communication with the measurement system (e.g. a production test system from Rohde&Schwarz).



### Main features

- ◆ Test of different DUTs and/or standards (e.g. GSM, WCDMA, *Bluetooth*) in the same test run
- ◆ Up to 12 DUTs
- ◆ Cost reduction of up to 80% compared to discrete solution (equipment and test time)
- ◆ Temperature range  $-40^{\circ}\text{C}$  to  $+80^{\circ}\text{C}$  (according to automotive component standards)
- ◆ Runs with any existing test system (e.g. production/conformance/QA test systems from Rohde&Schwarz)
- ◆ System software based on TestStand

### Specifications

Electrical data	
Frequency range	0.5 GHz to 3 GHz
Shielding effectiveness	>60 dB
RF connectors	N type
Temperature	
Temperature range	$-40^{\circ}\text{C}$ to $+80^{\circ}\text{C}$
Temperature change rate	3.5°C/min, typ.

General information	
Height	2 m
Width	19" rack
Position of DUT panel	1 m above floor
Test volume	>150 l
6 HU for other devices are provided inside of the shielded part	
R&S®E-Line is mounted on ESD wheels	
General feedthroughs within the system	RS-232-C, VGA, Ethernet, mouse and keyboard, mains, air inlet
Mains supply	380 V AC, 3 phase



Contents Overview

Chapter Overview

Type Index

R&S Addresses





Contents Overview

Chapter Overview

Type Index

R&S Addresses



## Type-Approval Systems for Mobile Radio



A complete range of systems for compliance tests to GSM, WCDMA, and *Bluetooth*® standards

### International benchmark for mobile radio test technology

Before being allowed onto the market, each and every mobile phone has to undergo a comprehensive series of checks which is referred to as the full compliance test (FTA). Rohde & Schwarz is the most important provider of system simulators of this kind for the world's most successful digital mobile radio systems.

### System solutions for all significant mobile radio systems

We provide a whole range of integrated systems and components for full compliance tests on mobiles. The approach we offer is technically innovative, practice-oriented and gives optimal performance and user-friendliness.

Type	Designation	Applications	Page
R&S®TS8950G	RF Test System for GSM/GPRS/EDGE Mobiles	Reliable RF testing all the way from development to conformance testing	331
R&S®TS8950W	RF Test System for WCDMA Mobiles		331
R&S®TS8960	<i>Bluetooth</i> ® Qualification and Compliance Test Systems	Full compliant to <i>Bluetooth</i> ® RF test specification	334
R&S®TS8965	RF Test System	Ideal test solution for RF pre-qualification and quality assurance in the development process	335

### We set the standards – you enjoy the benefits

With our compliance systems, you are ensured a high level of standard conformity and result reproducibility. This is why they have been accepted as standard test tools by test houses and accredited testing organizations all over the world. Mobile radio manufacturers know that equipment that has been developed using our systems will have no problems with official acceptance tests. You can be sure of the successful outcome of approval procedures without any bother.

### Future-proof thanks to high flexibility

The most striking features of the test systems from Rohde & Schwarz are the highly flexible hardware and software concepts which can be adapted to any changes in standards and any new technical requirements. Service packages tailored to your individual requirements secure your investment in equipment and keep your equipment at the leading edge of technology.



Contents Overview

Chapter Overview

Type Index

R&S Addresses





Contents Overview

Chapter Overview

Type Index

R&S Addresses



## RF Test System Family R&S®TS895x

**Reliable RF testing all the way  
from development to conformance  
testing**

### R&S®TS8950G

for GSM/GPRS/EDGE mobiles

R&S®TS8950W for 3G mobiles

R&S®TS8955G/R&S®TS8955W

for prequalification



### Brief description

The R&S®TS8950G/TS8950W are designed to perform RF tests of the transmitter and receiver of GSM/WCDMA mobile phones. These tests cover, for instance, measurements of the output spectrum produced by the mobile to evaluate the signal quality and to check possible interference with other services. For the receiver tests, interfering signals are added and signal propagation conditions are simulated using a fading simulator. In this case, the R&S®TS8950G/TS8950W measure the receiver sensitivity to these disturbances by calculating the information loss (BER, BLER, FER). The test functionality of the R&S®TS8950G/TS8950W is implemented as test methods. Each test method provides a generic test application and is fully configurable. Test cases are described by parameter sets. This provides significant benefits:

- ◆ Easy variation of test parameters for testing above and below the pre-defined test limits
- ◆ Fast definition of new tests (for development)
- ◆ Consistency between development tests and conformance tests
- ◆ Clearer view on the real performance of the mobile phone

### Main features

- ◆ TS8950G for RF tests according to 3GPP TS51.010-1, section 12, 13, 14, 21 and 22
- ◆ TS8950W for RF tests according to 3GPP TS34.121, section 5, 6 and 7
- ◆ Freely configurable RF test methods for R&D
- ◆ Supports GSM Ph2/Ph2+, GPRS, EDGE and AMR
- ◆ Supports WCDMA
- ◆ Open interfaces for easy integration into individual lab concept
- ◆ Control of custom equipment

### Applications

#### Development of GSM mobile phones

Each of these test packages includes a fully configurable test method and example parameter sets. All parameters can be freely varied through the graphical user interface. The measurement results can be analyzed either with the R&S®TS8950 control center or with other customer-specific software tools.

#### Conformance testing of GSM mobiles

Together with the test methods, the parameter sets for the relevant test cases to 3GPP TS51.010-1 and 3GPP TS34.121 are supplied as write-protected, frozen files. All test cases will be validated by independent test houses.



Contents Overview

Chapter Overview

Type Index

R&S Addresses





Contents Overview

Chapter Overview

Type Index

R&S Addresses



## RF Test System Family R&S® TS 895x

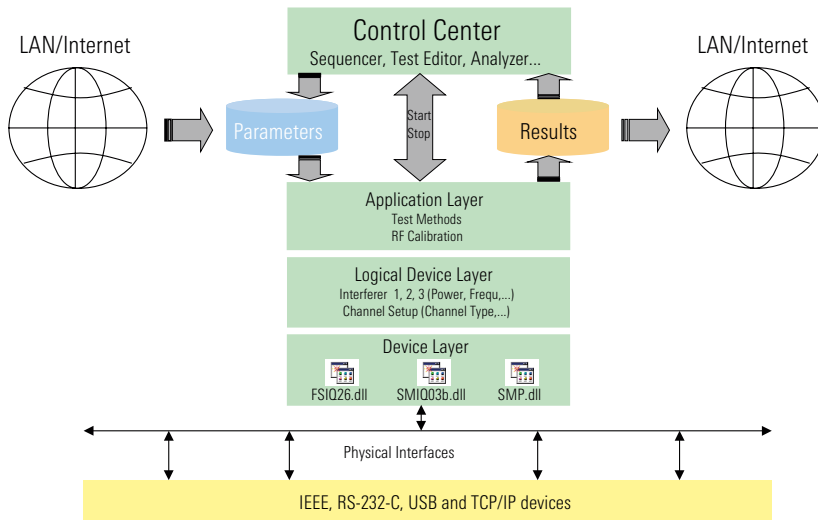

*R&S® TS 8950 software structure*

### Platform concept

The R&S® TS 8950G/TS 8950W test system has been developed as a true platform to cover the full range of mobile phone RF tests. The test philosophy of the R&S® TS 8950G/TS 8950W is to have one core system for all extension levels. This core system ensures measurement accuracy and provides appropriate interfaces at the hardware and software level, allowing user friendly system configuration. The R&S® TS 8950G/TS 8950W is available with different extension levels:

### Receiver performance test systems R&S® TS 8955G/TS 8955W

The lowest extension level of the includes a Radio Communication Tester R&S® CMU 200 as the signalling unit and BER tester, with one or more signal generators to produce interfering signals and with a baseband fading simulator. The purpose of this minimum configuration is to evaluate the performance of a mobile receiver. If more detailed protocol functionality is required, a Universal Protocol Tester R&S® CRTU-G for GSM can be installed instead of the R&S® CMU 200.

### Basic RX/TX test system

This system is equipped with the basic RF equipment including a vector signal analyzer. The signalling unit in the basic RX/TX test system is either a R&S® CMU 200 (R&S® TS 8955) or a R&S® CRTU-G (R&S® TS 8950) protocol tester.

### Full-performance RF test systems R&S® TS 8950G/R&S® TS 8950W

The full system with R&S® CRTU-G protocol tester and band-specific signal conditioning units (ASCUs) for each GSM band is the solution for conformance testing. It allows full comparison with measurement results obtained by means of one of the low-extension versions.



Contents Overview

Chapter Overview

Type Index

R&S Addresses



[Contents Overview](#)[Chapter Overview](#)[Type Index](#)[R&S Addresses](#)

## RF Test System Family R&S®TS895x

### Customizing the system configuration

The R&S®TS8950 control center RS-PASS allows flexible device handling: Instruments can be easily integrated into the system or removed from it without downtime. The instruments' capabilities are abstracted in a logical device layer, making the system widely independent of the individual instruments.

### Custom control/analysis

The test methods in the R&S®TS8950G/TS8950W are single executable files. This allows also the use of other software tools for system control, so that existing lab automation software can be extended to control the R&S®TS8950G/TS8950W. Parameter files and result files can be accessed from anywhere within the company network so that test design and analysis can be performed offline allowing optimum utilization of human and test resources.

### Access to the signal path

The R&S®TS8950 switch unit provides access to both transmit and receive signal paths. Multiple RF connectors at the rear of the switch unit allow the introduction of customer-specific signal conditioning elements whenever required.

### Further Characteristics

#### RF Path Calibration

The signals within the R&S®TS8950G/TS8950W systems are routed through a signal switching and conditioning unit. So no manual changes of the measurement setup, which can cause unpredictable path losses and phase shifts, are required. The switch unit has been optimized for reliability and accuracy. All signal paths used by the test applications are automatically calibrated for frequency-dependent losses. This includes connectors and different DUT (device under test) cables. The fixed internal cabling makes the switch unit insensitive to phase shifts. The R&S®TS8950 system monitors the performance of the RF paths to ensure optimum consistency and reproducibility of measurement results, which leads to a maximum confidence level.

#### Temperature monitoring

To further increase the information obtained by the tests executed, it is possible to monitor and record the temperature of the test site and the DUT with up to 3 PT100 probes.

### Extensions/upgradability

The R&S®TS8950G/TS8950W is designed for RF testing of GSM/GPRS/EDGE/3G mobiles operating in the GSM 850/900/1800 or GSM 1900 frequency band and three WCDMA bands (FDDI, FDDII and FDDIII). Extensions for other frequencies are easily possible. The R&S®TS8950GW is a combined test system for GSM and WCDMA.

[Contents Overview](#)[Chapter Overview](#)[Type Index](#)[R&S Addresses](#)



Contents Overview

Chapter Overview

Type Index

R&S Addresses



## Bluetooth Qualification and Conformance Test Systems R&S®TS8960



### Conformance Test System for Bluetooth RF Qualification, validated by Bluetooth SIG

#### Brief description

R&S®TS8960 is a qualification measurement system that is based on the *Bluetooth* Core Specification 1.2 and the *Bluetooth* RF Test Specification 1.2 which contains the obligatory RF measurements for the qualification of *Bluetooth* devices. The system can be used for conformance testing as well as for testing during the development phase and quality assurance process. For this purpose, the parameters of the test cases can be changed in a wide range.

Besides the test cases, the system offers a sophisticated software for RF path compensation. The wanted and interfering signals as well as the signal from the EUT are combined or split, attenuated or amplified, filtered and switched in a signal switching and conditioning unit (SSCU).

In addition to path compensation, the system offers a selftest. During this test, the main functions of the system devices are checked to ensure specification-conformant execution of the test cases. During the execution of the application programs (selftest, path compensation and test cases) a detailed test report is generated. The automatically generated test reports with measurement diagrams are suitable for submittal to the BQB (Bluetooth Qualification Body) to obtain qualification for the *Bluetooth* device under test.



The system is controlled via a graphical user interface. The software platform is LINUX (version 7.3), the graphical user interface is based on the Qt Library.

- ◆ Comprehensive selftests and high measurement accuracy due to automatic path compensation
- ◆ Additional options: remote control of climatic chamber, etc.

#### Main features

- ◆ All test cases to *Bluetooth* RF Test Specification v1.2 implemented as automatic test routines (for qualification)
- ◆ All test cases executable with variable parameters (for development and optimization)
- ◆ Additional test cases (free receiver, search sensitivity)
- ◆ Signalling unit for "Signalling" test mode upgradeable to protocol tester (R&S®PTW60) for *Bluetooth*® signalling tests according to test specification 1.1

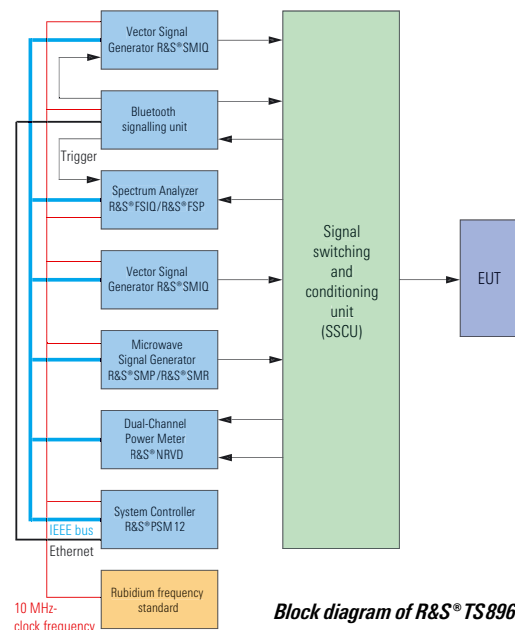

Contents Overview

Chapter Overview

Type Index

R&S Addresses





Contents Overview

Chapter Overview

Type Index

R&S Addresses



## RF Test Systems R&S®TS8965

**Ideal test solution for RF pre-qualification and quality assurance in the development process**



### Brief description

The R&S®TS8965 offers an ideal test solution for RF pre-qualification and quality assurance in the development process. The RF test system is adapted to the *Bluetooth*® Core Specification 1.2 and the *Bluetooth*® RF test specification 1.2, which defines the RF measurements for the qualification of *Bluetooth*® devices.

In the basic version the R&S®TS8965 is able to support 8 test cases, i.e. 7 transmitter and 1 receiver test cases. By adding further software and hardware options the R&S®TS8965B can be upgraded to a pre-qualification RF test system that supports all 15 RF test cases (non-compliant) of the above mentioned test specification plus the spurious emissions test case of test specification 1.1.

### Main features

- ◆ Cost-efficient RF test system for *Bluetooth*® RF development and verification
- ◆ Performs all in-band transmitter test cases and maximum input level receiver test case in basic version (non-compliant)
- ◆ Extendable to the full set of 15 + 1 test cases, i.e. 5 test cases by software upgrade and 3 test cases by hardware and software upgrade (non-compliant)
- ◆ The R&S®TS8965 can be upgraded to the full qualification *Bluetooth*® RF Test System R&S®TS8960
- ◆ Contains standard test instruments, which can as well be used outside the *Bluetooth*® RF Test System R&S®TS8965
- ◆ Contains the Rohde&Schwarz signaling unit, which can be upgraded to the *Bluetooth*® Protocol Tester R&S®PTW60

- ◆ Uses same well tried software platform and user-friendly GUI as the *Bluetooth*® RF Test System R&S®TS8960
- ◆ Creation of own test scenarios by variation of parameters
- ◆ Automatic generation of detailed test reports
- ◆ Built-in self-test ensures reliability of test results
- ◆ Static calibration tables guarantee defined measurement results

### Hardware Components

- ◆ System Controller (R&S®PSL3)
- ◆ *Bluetooth* Signaling Unit R&S®PTW60
- ◆ Spectrum Analyzer R&S®FSP
- ◆ Signal Conditioning Unit R&S®SCU-BT
- ◆ RF Signal Generator R&S®SMIQ03B
- ◆ Microwave Signal Generator R&S®SMR20 or Signal Generator R&S®SML01
- ◆ Power Meter R&S®NRVD



Contents Overview

Chapter Overview

Type Index

R&S Addresses





Contents Overview

Chapter Overview

Type Index

R&S Addresses



## Coverage Measurement Systems (Mobile Radio or DAB) – Overview



### Successful know-how transfer: innovative ideas for coverage measurements

In the field of radio coverage measurements too, the name of Rohde&Schwarz has over the years become worldwide synonymous with top quality. As the only manufacturer of a complete range of high-performance and practice-oriented system solutions, Rohde&Schwarz is setting standards in this field.

### Customer satisfaction is your capital – and your dividends

Our systems are unrivalled regarding fast and high-precision field-strength measurements wherever the location may be, detailed analysis of the receiving conditions for digital radio signals and absolute reliability of the measured data, e.g. through compliance with the Lee criterion. They thus create the basis for interference-free network operation as well as for the economic success of your network. Only a satisfied customer will be a faithful customer too. Therefore your aim should be lasting customer satisfaction which will pay out dividends over and over again.

### The optimized network – minimum investment returning maximum performance

Whether in densely built-up areas or in the mountains: the patented interference measurement equipment of Rohde&Schwarz will show you how many base stations are in fact required and where it is best to install them. You benefit two-fold: low investment costs in the network installation phase and maximum reliability in the operational phase. Your customers will appreciate it.

### Digital mobile radio systems – a new challenge to measurement technology

Multipath reflection, scatter, diffraction and interference mean a new challenge to every operator in the digital radio network business. Digital mobile radio systems are far more complex than their analog counterparts. Field-strength measurements alone often prove to be inadequate to evaluate the radio coverage in difficult areas. The unique, patented interference measurement system from Rohde&Schwarz analyzes the multipath propaga-

tion of a signal as well as noise or co-channel and adjacent-channel interference – and it detects extraneous signals. There is no potential interference factor whatsoever that is not taken into account. This means that with the measuring systems from Rohde&Schwarz you are always on the safe side and optimally equipped for future digital communication.

### Reliable planning through practice-oriented measurement

The dilemma in this context is that only practical experience will furnish useful data about the functioning of a network. This knowledge is required early in the planning phase to optimize the network prior to its commissioning. The solution is in operational measurements using test transmitters. The point of the Rohde&Schwarz solution is that our test transmitters are not only suitable for calibrating the planning software, but can be switched to signalling mode. This allows testing under realistic conditions with exactly the same signals that are later used by the network.



Contents Overview

Chapter Overview

Type Index

R&S Addresses







Contents Overview

Chapter Overview

Type Index

R&S Addresses



## Coverage Measurement Systems (Mobile Radio or DAB) – Overview

This stage will show whether the theoretically determined transmitter sites are suitable and the realistic receiving conditions are sound. It's no longer a matter of hope ("will it run smoothly?"). You can put your radio network installed with the aid of Rohde&Schwarz test equipment into operation and be sure that you provide the customer with a fully developed and tested infrastructure.

### From a single source

Efforts involved in building up a radio network are enormous: carrying out market

research, procuring the licence, ensuring financing, planning the sites, determining the mobile radio method, choosing the service and sales partners, setting up the administration network, installing the network, testing, optimizing and maintaining it. Therefore it is good to have reliable partners providing competent support in important areas of the implementation and ensuring that the project remains calculable both in time and in money. To live up to all this we supply a complete range of ideally matched measuring systems and components embedded in a consistent software environ-

ment. Whether you decide for budget-priced portable test mobile systems or fully equipped test vehicles, whether you wish to make field-strength measurements or signalling measurements – the solutions offered by us are technically innovative, proven in practice and feature maximum performance and ease of use. Numerous network operators – including all providers of full-coverage digital radio networks in Germany – rely on Rohde&Schwarz systems. Our range of cost-optimized network measurement tools certainly includes the right solution for your specific requirements.

### Overview of systems

Type	Designation	Description	Application	Page
R&S®TS9955	High-Performance Coverage Measurement System	High-performance measurement system for all coverage measurements; basic model for CW measurements; can be upgraded for signalling and interference measurements, Measurement Software R&S®ROMES	Field-strength measurement Signalling measurement Interference measurement Network optimization, quality monitoring Network planning and installation	338
R&S®TS9951 Outdoor	Portable Coverage Measurement System	Compact case system with 1 to 4 test mobiles for network-specific measurements as well as network comparison measurements	Signalling measurement Network optimization, quality monitoring Network installation	339
R&S®TS9951 Indoor	Handheld Coverage Measurement System	Special solutions for signalling measurements with 1 or 2 test mobiles	Signalling measurement Network optimization, quality monitoring Network installation	339
R&S®TS9958 ROGER	GSM Interference Analyzer	Quick and easy detection of CO and adjacent channel interferences for mobile applications	Network optimization Quality monitoring	345
R&S®TS9953	Test Transmitter System	System for emitting network-specific digital or CW signals	Signalling measurement Interference measurement Network planning and installation	348
R&S®TS9954 ROSEVAL	Evaluation Software	Evaluation software for all Rohde&Schwarz coverage measurement systems	Field-strength measurement Signalling measurement Data analysis Network optimization Network planning and installation	350
R&S®UMTS PN-Scanner	Drive Test Equipment	PN scanner is embedded in the modular software R&S®ROMES 3. It consists of a dedicated driver, which has to be installed in the basic R&S®ROMES 3 software	Network planning, design Installation, optimization Quality assurance Service	351
R&S®TSMU	Radio Network Analyzer	UMTS PN Scanner Compact System (R&S®TSMU + R&S®TSMU-K1)	UMTS interference analysis and network scanning on 3GPP networks	353



Contents Overview

Chapter Overview

Type Index

R&S Addresses





Contents Overview

Chapter Overview

Type Index

R&amp;S Addresses



## Coverage Measurement System R&S®TS9955 (Mobile Radio or DAB/DVB)

**Highly accurate and fast coverage measurements in mobile radio or DAB/DVB networks**



### Brief description

R&S®TS9955 is a high-performance system for measurements carried out in the planning, installation, optimization and quality monitoring of mobile radio or DAB networks. This system is not only suitable for high-precision and fast field-strength measurements, but in an upgraded configuration (see following pages) also for a comprehensive interference analysis which in this unique form is offered by Rohde&Schwarz only.

R&S®TS9955 means an investment in a highly efficient equipment providing extremely fast and reliable measurements. In its basic configuration for field-strength measurements, the system is able to measure four GSM900 channels simultaneously at a speed of up to 90 km/h (63 mph) and with the Lee criterion being adhered to, i.e. a distance of a few centimeters between the measurements. Preparing field-strength profiles and detecting any field-strength gaps is thus speeded up considerably so that accurate data required for calibrating the planning tools are quickly available.

### Main features

- ◆ Measurement of field strength; up to four GSM channels at a time at speeds of up to 90 km/h and the LEE criterion being complied with
- ◆ Frequency hopping over 124 channels
- ◆ All filters required for GSM900/1800/1900 and analog systems or DAB
- ◆ Integrated test mobiles for various standards
- ◆ Acquisition of RxQual, RxLev and layer-3 information via test mobile in GSM 900/1800/1900 and GPRS networks
- ◆ Acquisition of signalling data for other mobile communication standards such as ETACS and CDMA
- ◆ Collection of positioning data via GPS (Global Positioning System)
- ◆ Removable hard disk for easy data handling (PC card)
- ◆ Realtime graphics
- ◆ Ten user-definable event keys, various system events with freely definable thresholds
- ◆ User-friendly measurement software for controlling all system components
- ◆ Comprehensive evaluation software

### System configuration

The complete measurement equipment can be accommodated in a car. The system installed in the car mainly consists of test receiver, navigation systems, test mobiles, process controller and software. The core of the system is the powerful Test Receiver R&S®ESVD (R&S®ESVB for DAB, DVB-T and CDMA) which is not only extremely fast but also provides maximum level accuracy and frequency stability. Unlike conventional controllers, the robust Coverage Analyzer R&S®PCSP features excellent electromagnetic shielding so that it is absolutely neutral to the highly sensitive measuring equipment.

### Software

Measurement Software R&S®ROMES integrates and administrates all system components and is ideally supplemented by the Software Package R&S®TS9954 ROSEVAL (see page 350) for drafting and evaluating the test tours.



Contents Overview

Chapter Overview

Type Index

R&amp;S Addresses





Contents Overview

Chapter Overview

Type Index

R&S Addresses



## Coverage Measurement System R&S®TS9951 (Mobile Radio or DAB)

**Compact case system with 1 to 4 test mobiles for network-specific measurements and network comparison measurements**



### Brief description

**Out and about with compact systems**  
System R&S®TS9951 is a budget-priced compact solution for network-specific quality parameter measurements during network installation, but mainly for quality monitoring during regular network operations. Through the integration of the main system components in a robust transit case, the systems are ready for use at any time and easy to transport.

They can optionally be fitted with GSM900/1800/1900 test mobiles, as well as ETACS or CDMA test mobiles.

### Simultaneous measurement of different networks to save time

R&S®TS9951 with up to four (maximum of three GSM) test mobiles allow mobiles of different standards to be used at the same time to carry out simultaneous measurements on several networks available at a site, or various antenna models or antenna positions on the vehicle to be tested. The

test mobiles can readily be exchanged in no time. This flexibility is a great advantage in particular for service enterprises that have to carry out measurements on different networks on behalf of their customers often under an enormous pressure of time.

### The right system for every application

#### Different requirements call for different solution

- ◆ R&S®TS9951 for outdoor application with one to four test mobiles for measurements in operational network or for use in conjunction with Test Transmitter System R&S®TS 9953 (GSM technology)
- ◆ R&S®TS9951 for indoor measurements

### Main features

- ◆ Compact case system with built-in GPS receiver and with IBM-compatible laptop
- ◆ Test mobiles available for GSM900/1800/1900 CDMA or ETACS
- ◆ One, two, three or four test mobiles
- ◆ Test mobiles (level table storable)
- ◆ Basic measurement in passive idle mode – no call setup required
- ◆ Camp mode for determining the cell boundaries

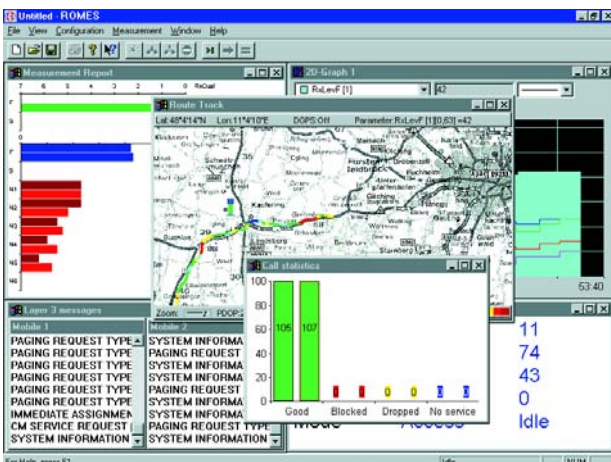

Coverage Measurement Software R&S®ROMES



Contents Overview

Chapter Overview

Type Index

R&S Addresses





Contents Overview

Chapter Overview

Type Index

R&S Addresses



## Coverage Measurement System R&S®TS9951 (Mobile Radio or DAB)

- ◆ Recording of signalling and analysis of OSI layer-3 information
- ◆ Realtime graphical display of test report
- ◆ Realtime alphanumeric display for presenting signalling information
- ◆ Realtime presentation of selected parameters on overlaid road maps
- ◆ Automatic or manual measurement mode
- ◆ Outdoor positioning with the aid of GPS navigation
- ◆ GSM Network Quality Analysis (NQA) Software running under Excel 5.0 or 8.0 for statistical evaluation of network availability, quality of connection, time required for call setup, call hold time, etc
- ◆ DC (12 V) or AC supply
- ◆ Indoor navigation modes

### System configuration

The systems use the intelligence of the radio telephones, i.e. they automatically find the operating frequencies of the radio service. The measurements are not only carried out in the dedicated mode, but also in the RxQual idle mode of the mobile. The great advantage of these systems is that quality measurements can be made in conjunction with a digital test transmitter such as the R&S®TS9953 (see page 348) so that a full-featured base station is not required.

The test mobiles used are modified by adding vital measurement functions. They also allow measurements on cell boundaries to be readily performed (camp mode). Moreover, the mobiles can be calibrated for high measuring accuracy. The built-in GPS receiver can be supplemented by a Travelpilot or sensor system to handle situations in which GPS reception via satellite is not possible, for instance in road tunnels.

### Software

R&S®TS9951 not only features an extraordinary hardware but also a very special software providing far more than the usual capabilities. In addition to the display of standard parameters such as RxQual, RxLev or SSI, this system also allows graphical processing of data and presentation on overlaid road maps.



R&S®TS9951 for indoor measurements

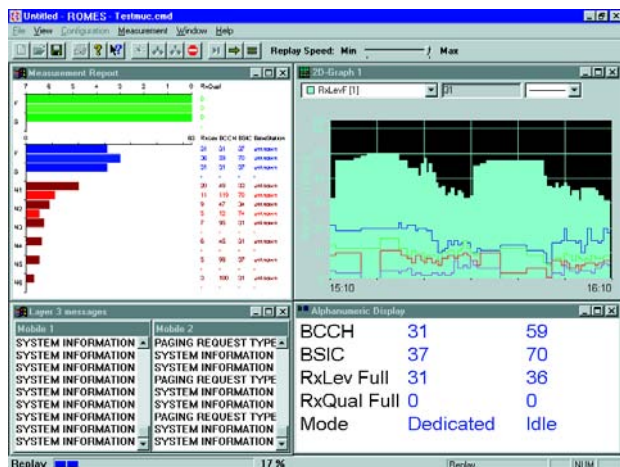

Four typical windows in replay mode

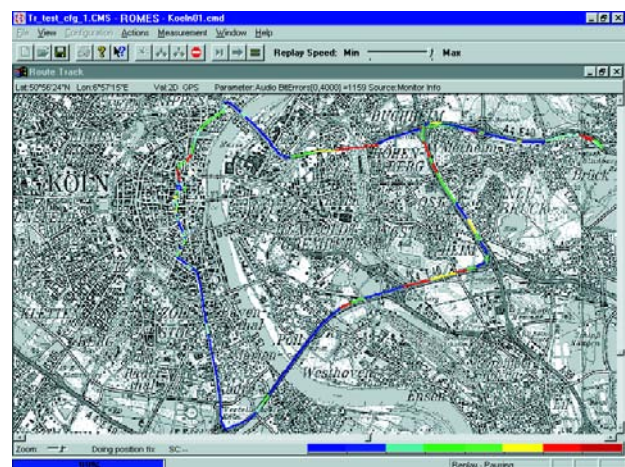

Full-screen display of Route Track window with a complete DAB test tour



Contents Overview

Chapter Overview

Type Index

R&S Addresses





Contents Overview

Chapter Overview

Type Index

R&S Addresses



## Test Platform for Mobile Phone Production R&S®TS7100/R&S®TS7180

**Scalable solutions from low-cost standard system to turnkey production system**

*Test System R&S®TS7180*



### Brief description

The R&S®TS7180 and R&S®TS7100 systems are flexible solutions for mobile phone production tests. The low-cost version R&S®TS7180 satisfies the requirements of most mobile phone production tests. The R&S®TS7100 test platform incorporates a powerful CompactPCI/PXI frame for the integration of a wide variety of additional test and switching modules. This is ideal for contract manufacturers, as it enables them to quickly and flexibly respond to widely differing customer requirements.

The systems can be used immediately or modified and extended to customer requirements. Constructed from standard components, they can be reproduced quickly and at low cost. They are easy to operate and can be smoothly integrated into any production environment.

### Main features

- ◆ Versatile applications
  - For all common mobile radio standards
  - For mass production and service
  - For all production steps including PCB tests, functional tests, RF adjustment and final tests covering RF, acoustic, keypad and display functions
  - Multiprotocol and multiband tests with Radio Communication Tester R&S®CMU200
- ◆ Scalable solutions
  - Comprehensive modular test library for immediate use or easy customization
  - Easy upgrade to 3rd generation mobile radios
- Scalable from low-cost platform R&S®TS7180 using industrial PC to modular system platform R&S®TS7100 using CompactPCI/PXI
- ◆ Cost-effective solution
  - Low-cost solution R&S®TS7180 with industrial PC
  - Maximum throughput owing to extremely short measurement times of R&S®CMU200 and real parallel testing using two independent IEC/IEEE bus systems
  - Easy upgrading for upcoming mobile radio standards
  - Test of several mobile radio standards with one R&S®CMU200
  - All hardware and software components based on industry standards



Contents Overview

Chapter Overview

Type Index

R&S Addresses





## Test Platform for Mobile Phone Production R&S®TS7100/R&S®TS7180

### Putting mobile phones through their paces

The R&S®TS7180 and R&S®TS7100 systems are equally suitable for functional tests on boards, RF calibration of mobile phones or final tests. Each function can be assigned test parameters under menu control. Sub-sequences can also be generated. This hierarchical structure makes it possible to set up even comprehensive test sequences conveniently and with high transparency. Each test step can be assigned result parameters and comparison operations for the conditional execution of actions, thus enabling program branching. At the end of each test run, a test report can automatically be generated from the results, or results can be stored in a database.

### Low-cost Production Test System R&S®TS7180

The R&S®TS7180 is a low-cost test system for the mass production of mobile phones. It supports all common mobile radio standards such as GSM, GPRS, CDMA (IS95), TDMA (IS 136), AMPS, cdma2000 and WCDMA as well as tests on terminals with *Bluetooth* capability.

The two-channel version is capable of simultaneously testing two mobile phones. It essentially comprises two Radio Communication Testers R&S®CMU200, two special power supplies and two fixtures. The system is controlled by an industrial PC. The highly compact two-channel system is accommodated in a rack of only 23 HU, thus allowing room for expansions.

Alternatively, a low-profile rack is available. With a height of only 80 cm (13 HU), the complete system can be placed under

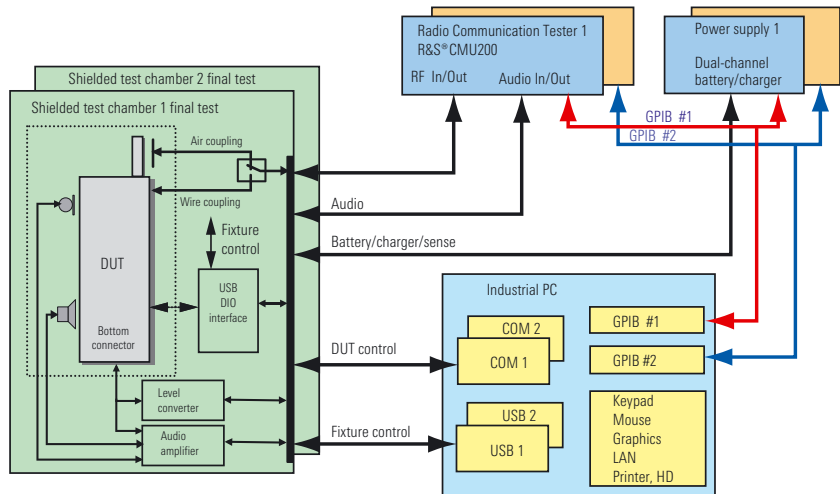

**Block diagram R&S®TS7180**

the conveyor belt of a production line. It is therefore ideal for subsequent use in fully automatic inline systems.

For manual operation, an extra fixture kit is available that can be extended on a modular basis from a simple PCB test fixture to a complete shielded test fixture for final testing including antenna and acoustic tests. The manual fixture can be used both with the R&S®TS7180 and the R&S®TS7100.

Complete, ready-to-run test sequences make test program generation easy even for users without any programming expertise. The sequences are made up of function calls from the different generic test software libraries (GTSL) and can easily be modified and adapted using the TestStand editor.

GTSL supports all common mobile radio standards and is continually being expanded. User libraries can be added, for example to drive additional devices or the DUT. GTSL also supports all functions relevant in a production test environment

including signal switching, fixture control and RF path compensation. Debugging, data storage and logging are performed by the TestStand test executive from National Instruments. The GTSL software and the TestStand test executive run on both systems.

### R&S®TS7100 is the ideal platform for complex test requirements

The R&S®TS7100 test system uses a CompactPCI/PXI frame with an embedded controller (PC) instead of the industrial PC employed by the R&S®TS7180. The remaining hardware components and the system software are identical. The CompactPCI/PXI frame allows for extra functionality by installing additional plug-in boards such as relay modules for path switching, AF generator, AF analyzer, A/B interface (e.g. for cordless telephones), digital multimeter, frame grabber for display tests, etc. The system can thus be adapted to complex test requirements and sequences quickly and flexibly.





## Test Platform for Mobile Phone Production R&S®TS7100/R&S®TS7180

### R&S®TS7100 features

- ◆ Software-compatible with R&S®TS7180
- ◆ PCB test with expanded AF, DC and digital testing requirements
- ◆ Simultaneous or multiplexed testing of several DUTs (modules) on one panel
- ◆ Multichannel systems comprising 4 channels for example, with 2 channels multiplexed in each case, for minimizing DUT handling times
- ◆ Control and test of additional interfaces
- ◆ Efficient selftest concept

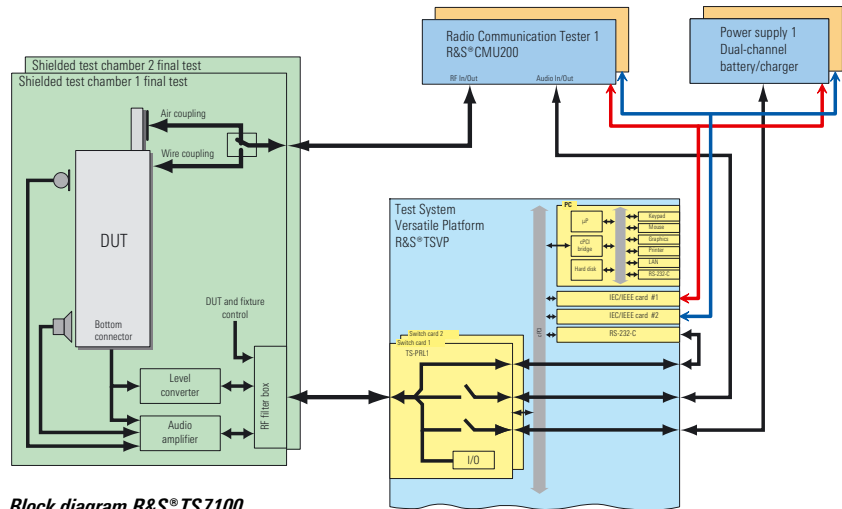

Block diagram R&S®TS7100

### CompactPCI/PXI – a compact and flexible standard

The R&S®TS7100 test system incorporates the CompactPCI/PXI system platform R&S®TSVP (Test System Versatile Platform) with a maximum configuration of 31 slots. Within a single unit of 4 HU, this platform accommodates the system controller, relay modules, digital inputs and outputs and test modules in cases where these are not yet provided by the radio communication tester. The universal module R&S®TSPRL1, which offers relay, power relay and digital I/O functionality on a single module, already provides all basic functions required for mobile phone testing, including fixture control. Further measurement functions such as digital multimeters or relay matrix boards can be implemented as required.

The unique wiring concept of the R&S®TSVP makes it possible to route and switch all signals of the various test and stimulus modules entirely within the R&S®TSVP. Thus all signals can be tapped directly at the fixture interface, which allows simpler fixture and interface design. The PXI system architecture, now an industry standard, was developed

from CompactPCI especially for industrial T&M applications. It sets a new standard in flexibility and compactness. A large number of very different PXI modules are already available on the market. CompactPCI boards can also be used.

### Parallel test configuration

As in the case of the R&S®TS7180, parallel testing of two mobile phones requires all components (R&S®CMU200, power supply, plug-in boards) to be provided in a dual configuration. The IEC/IEEE bus must also be provided in duplicate to achieve optimal performance. Duplicating the CompactPCI/PXI platform is not necessary due to its high performance. The IEC/IEEE bus devices and the plug-in boards are therefore driven simultaneously in multitasking mode by an embedded system controller under WindowsNT/2000.

### Test system software

The software for the R&S®TS7100 and R&S®TS7180 test systems was designed with easy system operation and speedy

test program generation in mind. The user need not have expertise in IEC/IEEE bus programming. C programming and compiling at the test sequence level are also not required. The software is of modular design and comprises a test sequence controller and a comprehensive test case library for mobile phones of different standards.

### A wealth of functionality for production testing

The TestStand test executive from National Instruments is used for test sequence control. This software package combines setup and measurement functions to form an executable test sequence and adds all other functions important for the manufacturing process:

- ◆ User administration
- ◆ Execution of several test sequences in multithreading or parallel mode
- ◆ Collection and storage of results
- ◆ Report generation



## Test Platform for Mobile Phone Production R&S®TS7100/R&S®TS7180

### Open system architecture for flexible extension

In addition to the large number of libraries supplied with the test system, the customer can create libraries of his own that include typical GTSL features such as multithreading or RF path compensation. For this purpose, example source code for the LabWindows/CVI design environment from National Instruments is provided. Typical applications include DUT control in special test modes, special adjustment routines and the integration of additional system components.

### Test programs and fixtures

For mobile phone testing, Rohde&Schwarz also develops test programs and custom test and adjustment functions and supplies test fixtures. Depending on requirements, the fixtures incorporate built-in shielding for acoustic and RF measurements and a mechanical actuator for the keypad test. For RF tests, the fixtures are equipped with special antennas and an RF connection to the test system.

Because of our many years of experience in mobile phone production testing – including with a variety of reference designs from chip set manufacturers – Rohde&Schwarz can offer optimized solutions that cover the entire spectrum from adjustment up to final testing.

#### Fixture features

- ◆ RF and acoustic shielding
- ◆ Exchangeable DUT mount
- ◆ Simple DUT interfacing
- ◆ USB control, i.e. no extra interface cards needed in PC (only for Windows2000)

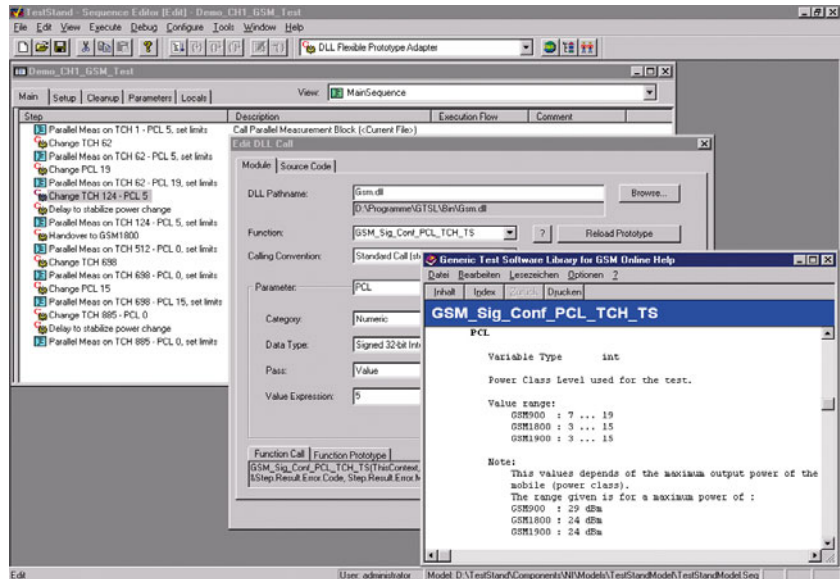

Sequence editor

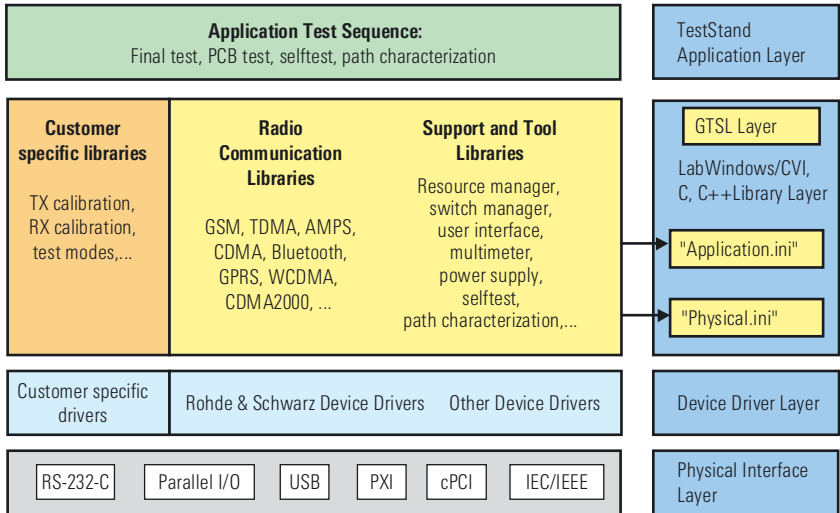

Block diagram GTSL architecture

Customer specific software + Generic Software

- ◆ Fixture interface for R&S®TS7180 and R&S®TS7100
- ◆ Status display for operating personnel
- ◆ Suitable for any RF tests on DUTs
- ◆ Spring contacts
- ◆ Pneumatic control for closing the cover
- ◆ Built-in RF antenna
- ◆ Built-in artificial ear and mouth
- ◆ Pneumatic key actuation
- ◆ Unused feedthroughs for additional signals





Contents Overview

Chapter Overview

Type Index

R&S Addresses



## GSM Interference Analyzer R&S®TS9958 ROGER

**Quick and easy detection of CO and adjacent channel interferences for mobile applications**



### Brief description

The GSM Interference Analyzer R&S®TS9958 is a highly practical solution for co-channel interference measurements that are mobile and fully automatic, making the way for simple analysis.

R&S®ROGER consists of:

- ◆ Test Receiver R&S®TS55-RX
- ◆ up to four test mobiles of different make
- ◆ a GPS receiver
- ◆ a process controller equipped with A/D converter card and signal-processing card

Test Receiver R&S®TS55-RX is accommodated in the controller, making R&S®ROGER a highly compact, lightweight unit. The system uses Coverage Measurement Software R&S®ROMES3, affording a state-of-the-art operating concept and the repeated use of position data sources and mobile-phone linkups. Using an indoor module, the software even allows interference detection inside buildings. R&S®ROGER can optionally be fitted with a position trigger so that it can carry out classic measurement of coverage in addition to interference. In particular the option of extending the system by up to eight additional mobiles of differ-

ent standards (GSM 900/1800, CDMA, GPRS) allows space- and cost-saving performance of different tasks with a single unit.

### Main features

- ◆ Fully automatic measurements, no manual control necessary
- ◆ Mobile measurement detects interferences everywhere
- ◆ Easy and simple evaluation of the real source of interference
- ◆ For all GSM/GPRS networks with hopping or non-hopping channels
- ◆ Not only experts can make reliable mobile C/I measurements
- ◆ Quick and reliable graphical evaluation
- ◆ A MUST for GPRS networks due to high data transmission rates
- ◆ Drastic reduction of all measurement costs
- ◆ Significant improvement of fast and reliable results
- ◆ Real interferer identification within seconds

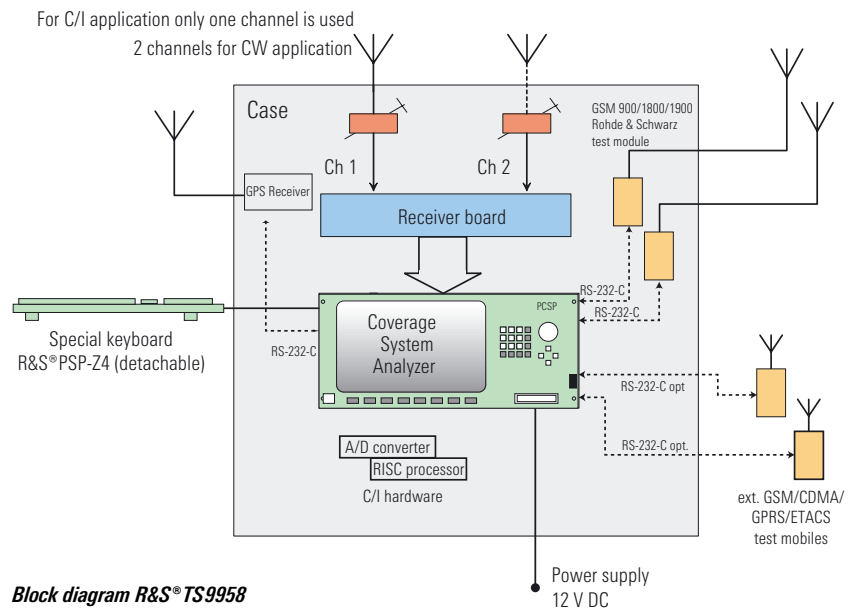

Contents Overview

Chapter Overview

Type Index

R&S Addresses





Contents Overview

Chapter Overview

Type Index

R&S Addresses



## GSM Interference Analyzer R&S®TS9958 ROGER

### How R&S®ROGER works

Just a short configuration of R&S®ROGER, and the test can start. The test run is automatically controlled by up to four mobile phones, doing away with any manual control. High vehicle speeds are no problem for R&S®ROGER either. Interference measurement is performed in three steps:

- ◆ detection of interference
- ◆ measurement of interfered/interfering signals
- ◆ assignment of these signals to base stations

The signals found can be assigned to the emitting base stations already during the test tour or afterwards on a conventional PC.

### Signal display

There are signal displays for two test modes: for C0 (BCCH) and Cx (TCH) measurements. From the disturbed composite signal, R&S®ROGER filters out frequency-correction bursts (FCCHs) for the identification of C0 carriers and displays them. The time axis is structured in lines comparable to a TV frame, arranged such that neighbouring FCCHs of an M51 frame (51 TDMA frames) come vertically one below the other. Because of the idle burst at the end of each M51 frame, a staircase pattern is obtained for each detected C0 carrier. So the graphical presentation of the C0 channel of the serving cell (SC) reveals a staircase with the FCCHs of the SC itself and further patterns in the case of C0 interference. In the analysis window for adjacent channels or TCH channels of the SC, each staircase pattern indicates the presence of C0 interference.

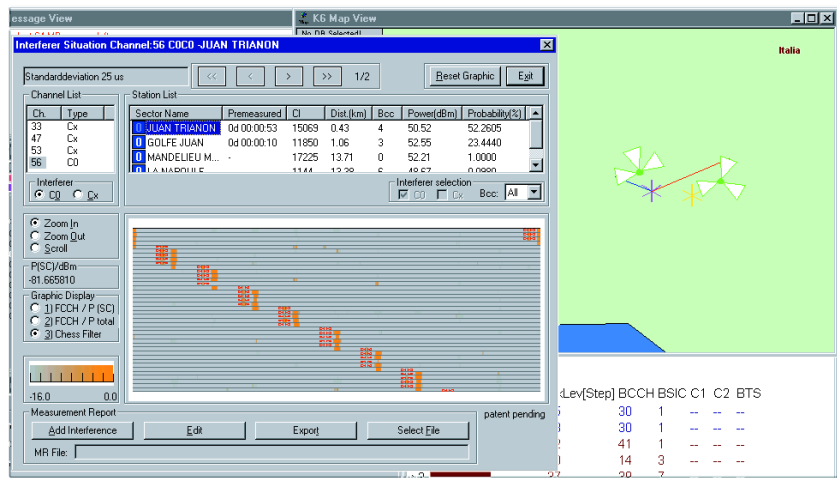

R&S®PCSD-K6 Evaluation Display (here BCCH (C0) with interference from another BCCH (C0))

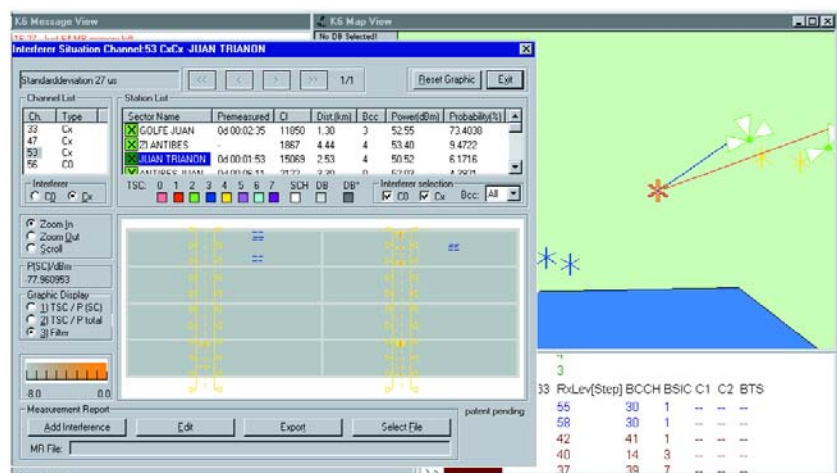

R&S®PCSD-K6 Evaluation Display (here TCH (Cx) with interference from another TCH (Cx))

In Cx measurement, the composite signal is analyzed in greater detail. Synchronization as well as dummy-burst and training sequences are filtered and visualized grouped according to timeslots. The measured sequences of different base stations are shown in time grids corresponding to two vertical stripes in the Cx display. Different base stations are represented by stripes at different positions along the x axis. Interference can be iden-

tified immediately: from any further stripes displayed next to the two SC stripes. In mobile measurements, the selected signals fluctuate due to fading, reflection and other external influences, resulting in a variety of signal patterns. R&S®ROGER therefore processes interference signals for graphical representation, as the human eye can analyze complex patterns with high reliability.



Contents Overview

Chapter Overview

Type Index

R&S Addresses





Contents Overview

Chapter Overview

Type Index

R&S Addresses



## GSM Interference Analyzer R&S®TS9958 ROGER

### Fast identification of base stations

To trace interference back to the emitting base station, a feature characteristic of each BTS is used: the expected arrival times of specific signals at the measuring instrument. The times are determined from the measurement position, the expected sending time and the site of the BTS. When a BTS is selected, the expected arrival time is superimposed on the displayed sequences in the form of a template. If this matches a signal measured, the latter can be assigned to the selected BTS. In the case of Cx measurements, the number of possible base stations is reduced by a factor of eight to

those whose base-station colour code and training-sequence code are identical. The selected BTS is additionally shown on a map, allowing comparison of the propagation conditions of server and interferer.

### Power measurement

In the interference charts, the power values are colour-coded, allowing a basic evaluation of interference. For purposes of optimization, the measurement system provides the dynamic C/I value for each base station after the SC and interference signals have been selected. The measured and averaged power values can be visualized and if necessary modified.

Modification enables evaluation of the range of interference obtained with mobile measurements. The results of power analysis are stored in a file, and a test report of the analyzed interference signals is generated. The latter may serve as a basis for network modifications.

## Specifications in brief

Controller	
Processor	AMD K6, 300 MHz minimum
RAM	32 Mbyte (standard), with PSP-B2 expandible to 64 Mbyte 512 kbyte cache
Hard disk	1.6 Gbyte minimum
Disk drive	1.44 Mbyte, 3½"
Operating system	MS Windows 98/2000/XP
Test & measurement software	LabWindows/CVI
Display	
R&S®PSP2	none
R&S®PSP7	LCD colour, 8.4", screen anti-glare
Resolution with integrated LCD for external monitors	VGA standard: 640 × 480 pixels 1280 × 1024, 1024 × 768, 800 × 600, 640 × 480 pixels, 2 Mbyte video memory
Interfaces	
Internal	ISA, 3 × 16 bits
External	
IEC/IEEE	IEEE488.2, compatible with NI TNT
Serial	2 × RS-232-C
Printer	Centronics LPT1 (ECP, EPP)
PCMCIA	release 2.0, type III, connector
Keyboard, mouse	5-contact DIN, 5-contact PS/2
Interference measurements	
Detection and analysis of C0 and Cx interferences	GSM 900, GSM (DCS) 1800 and GSM (PCS) 1900 networks on the C0 (BCCH), Cx (TCH) and optionally on adjacent channel of the Serving Cell (SC)
Trigger on interferences	automatically or manually based on 1 to 4 GSM test mobiles

Displayed dynamic range		
Type of interference	Total <sup>1)</sup>	compared to SC <sup>2)</sup>
C0 – C0	–16 dB to 0 dB	–13 dB to 3 dB
Cx – C0	–16 dB to 0 dB	–13 dB to 3 dB
Adj – C0	–8 dB to 0 dB	–8 dB to 8 dB
C0 – Cx	–8 dB to 0 dB	–10 dB to 6 dB
Cx – Cx	–8 dB to 0 dB	–10 dB to 6 dB
Adj – Cx	–8 dB to 0 dB	–8 dB to 8 dB

1) Compared to the total power in the underlying time slot.

2) Compared to an average power level of the SC, measured directly before and after the actual interference.

General data	
Rated temperature range	+5 °C to +45 °C
Operating temperature range	0 °C to +50 °C
AC supply	100 V to 120 V ±10%, 50 Hz to 400 Hz 220 V to 240 V ±10%, 50 Hz to 60 Hz
DC supply	DC, 12 V
Max. power consumption	300 W typ. (12 V DC/25 A)
Dimensions (W × H × D)	500 mm × 200 mm × 800 mm
Weight	19.8 kg

## Ordering information

<b>GSM Interference Analyzer R&amp;S®ROGER</b>	R&S®TS9958	1132.2506.02
Options		
Additional, external GSM/GPRS Test Mobiles	on request	



Contents Overview

Chapter Overview

Type Index

R&S Addresses





Contents Overview

Chapter Overview

Type Index

R&S Addresses



## GSM Test Transmitter System R&S®TS9953

**Ideal positioning of base transceiver stations in frequency and network planning**



### Brief description

#### Planning of base transceiver stations

Complex frequency planning tools are used to ensure optimum positioning of a base transceiver station (BTS). The efforts involved, especially for tasks such as obtaining permissions, rental agreements etc, are very high. The GSM network operator therefore needs to be sure that the site calculated is suitable for the BTS installation.

#### Test Transmitter System R&S®TS9953 fulfils all requirements

- ◆ Unmodulated transmitter:  
CW data obtained by means of a test receiver serve as a feedback and for the calibration of frequency planning systems
- ◆ Modulated transmitter:  
For measurement tasks in network optimization, a BCCH bit sequence is transmitted by the system as a modulation signal for synchronization with a GSM test mobile. RxLev and RxQual are measured using suitable test mobiles (R&S®TS95XMO, R&S®TS95MMx).

A GSM antenna with appropriate alignment and downtilt is set up on a stable tripod (4 m) or a robust, small mast (5.4 m) on the site determined for a BTS. The

antenna is fed by a 20 W amplifier via an RF cable.

The amplifier is equipped with a GMSK modulator connected ahead of the built-in RF oscillator. A BCCH test sequence stored in the transmitter supplies the modulation signal. The test transmitter simulates a BTS on the downlink.

If the theoretically determined site proves to be unsuitable for a BTS, the test team can simply choose an alternative site since the R&S®TS9953 system is so easy to set up. The data measured on the new site can subsequently be confirmed by the frequency planning department.

### Main features

- ◆ Modular transmitter system
- ◆ RF amplifier, CW transmitter (generator, amplifier), GSM test transmitter (modulator, generator, amplifier)
- ◆ Three convenient RF power classes: 2 W, 20 W, 50 W (on request)
- ◆ 2 W GSM test transmitter as exciter for subsequent booster
- ◆ Extremely easy selection of frequency and output power
- ◆ Built-in display for forward and reflected power, and VSWR
- ◆ Rugged cabinet design suitable for transportation

- ◆ Comprehensive useful accessories (weather protection, tripods, antennas, cables, power meter, emergency power supply)

### R&S®TS-TX9 and R&S®TS-TX18

For handling measurement tasks within buildings or microcell structures Rohde & Schwarz has developed two very compact test transmitters with 2 W output power. They can be operated via built-in batteries or an external power supply unit. These mini-transmitters are also fitted with a built-in GMSK modulator/oscillator. A suitable BCCH sequence can be loaded via the serial interface. 2 W GMSK transmitters come in two models:

- ◆ R&S®TS-TX9 for GSM900, GSM-R, GSM-E
- ◆ R&S®TS-TX18 for GSM 1800



Mini-transmitter  
R&S®TS-TX

A control circuit monitors the set RF power and battery voltage. If a constant RF level cannot be ensured by the supply



Contents Overview

Chapter Overview

Type Index

R&S Addresses



## GSM Test Transmitter System R&S®TS9953

voltage, the test transmitter is switched off to prevent erroneous measurements. The 2 W GSMK Transmitter R&S®TS-TX9/ R&S®TS-TX18 can also be used as an exciter for subsequent RF boosters.

### R&S®TS9953 for UMTS/WCDMA

To find out about the real propagation conditions in future UMTS/WCDMA networks, a 20 W RF amplifier is available that is ideally suited for the next genera-

tion of mobile radio networks because of its wide frequency band (800 MHz to 2700 MHz). This amplifier can be driven by a generator with WCDMA capability (e.g. R&S®SME03E, R&S®SMIQ) and then supplies a signal that can be measured with conventional coverage measurement systems (e.g. R&S®TS9955).

A suitable converter for the frequency band expansion is available for the Test Receivers R&S®ESVD/ESVB.

### BCCH Editing Software R&S®TS53-K1

The R&S®TS53-K1 software allows easy generation of individual BCCH bit sequences. R&S®TS53-K1 runs under Windows 9x, NT or 2000 /XP on a PC, laptop or notebook and can be used for all R&S®TS9953 systems.

The sequence is loaded to the modulators via a serial interface.

## Specifications

<b>Frequency range</b>	
R&S®TS-AMPG	935.2 MHz to 959.8 MHz / channels 1 to 124
R&S®TS-AMPD	1805.2 MHz to 1879.8 MHz / channels 512 to 885
R&S®TS-TX9	921 MHz to 959.8 MHz (incl. GSM-R and GSM-E)
R&S®TS-TX18	1805.2 MHz to 1879.8 MHz / channels 512 to 885
Channel spacing	200 kHz
CW mode	unmodulated carrier
GMSK modulation mode	BCCH sequence max. 8 Mbit
<b>Frequency settings</b>	
R&S®TS-AMPG, R&S®TS-AMPD	by means of decade switches
R&S®TS-TX9, R&S®TS-TX18	via softkeys, indication on LCD
<b>Frequency stability</b>	
in operating temperature range	±0.1 ppm
short-term	±5.0 × 10 <sup>-10</sup> /s
long-term	±2.0 × 10 <sup>-9</sup> /day ±0.5 × 10 <sup>-6</sup> /year after 30 days of operation
<b>Output power</b>	
R&S®TS-AMPG, R&S®TS-AMPD	43 dBm; ± 1 dB (for 1 dB compression)
R&S®TS-TX9, R&S®TS-TX18	33 dBm; ± 1 dB (for 1 dB compression)
Harmonics suppression	>50 dBc
Nonharmonics suppression	>50 dBc
Overload switchoff	automatic
Service connector for data transfer	9-pin sub-D male
<b>RF connector</b>	
R&S®TS-AMPG, R&S®TS-AMPD, R&S®TS-UMTS	N female for input/output
R&S®TS-TX9, R&S®TS-TX18	SMA connector
<b>UMTS amplifier</b>	
R&S®TS-UMTS	800 MHz to 2700 MHz
Output power	20 W (25 W typ.)
Gain	40 dB (min. ±1.2 dB)
VSWR input	1.8 (max.)

## General data

Operating temperature range R&S®TS-AMPG, R&S®TS-AMPD, R&S®TS-UMTS R&S®TS-TX9, R&S®TS-TX18	-10°C to +40°C +5°C to +45°C
Power supply R&S®TS-AMPG, R&S®TS-AMPD, R&S®TS-UMTS R&S®TS-TX9, R&S®TS-TX18	230 V AC (47 Hz to 63 Hz) or 110 V AC 7.2 V battery
Cabinet R&S®TS-UMTS R&S®TS-AMPG, R&S®TS-AMPD R&S®TS-TX9, R&S®TS-TX18	19"/2 HU/300 mm depth 19"/3 HU/460 mm depth
Dimensions in mm (W × H × D)	84 × 260 × 35
Weight	approx. 700 g

## Ordering information

<b>R&amp;S®TS9953 System</b>		
GSM900 Generator Amplifier with internal GMSK Modulator	R&S®TS-AMPG	1070.5689.05
GSM1800 Generator Amplifier with internal GMSK Modulator	R&S®TS-AMPD	1072.1051.05
GSM900 Transmitter with internal GMSK Modulator	R&S®TS-TX9	1090.8460.02
GSM1800 Transmitter with internal GMSK Modulator	R&S®TS-TX18	1090.8477.02
Editor Software for generation of BCCH bit sequences on a PC	R&S®TS53-K1	1117.5714.02
UMTS Amplifier	R&S®TS-UMTS	1148.1804.02
<b>Accessories</b>		
Transportation Case, plastic cover for weather protection	R&S®TS-SUIT	1070.5908.04
Transportation Case	R&S®TS-SUIT	1070.5908.02
Transmitting Antenna for GSM900	R&S®HF065D1	4044.1508.02
Transmitting Antenna for GSM1800	R&S®HF065E1	4043.8509.02
Tripod, 4 m	R&S®TS-MAST	1070.5708.02
Portable Mast, 5.4 m	R&S®TS-MAST	1070.5708.04
7 m Antenna Cable	R&S®TS-CABL	1070.5714.02
Emergency Power Supply	R&S®TS-AGGR	1070.5737.02



Contents Overview

Chapter Overview

Type Index

R&S Addresses



## Evaluation Software R&S® ROSEVAL

**High-performance evaluation software for field-strength analysis**

### Brief description

The high-performance Evaluation Software R&S®TS9954 "ROSEVAL" (Rohde & Schwarz evaluation software) is an excellent tool for analyzing all measurement data from data collection systems (Systems R&S®TS9951 or R&S®TS9955) by means of different methods.

With the aid of this software the user can ensure high network quality during the installation, optimization, service and maintenance of his network. As a Windows application it can easily be handled and installed on a standard PC. The concept is modular and adaptable to the most familiar digital networks like GSM, ETACS, CDMA.

As a subunit the well-known GIS software MAPINFO is used for geographical evaluations. The full power of this embedded software is open for designing new customer-specific layers.

### Main features

- ◆ Generation of structured meta files
- ◆ Highly effective evaluation through the use of filtered and selected data
- ◆ Efficient file management of measurement data (central server)

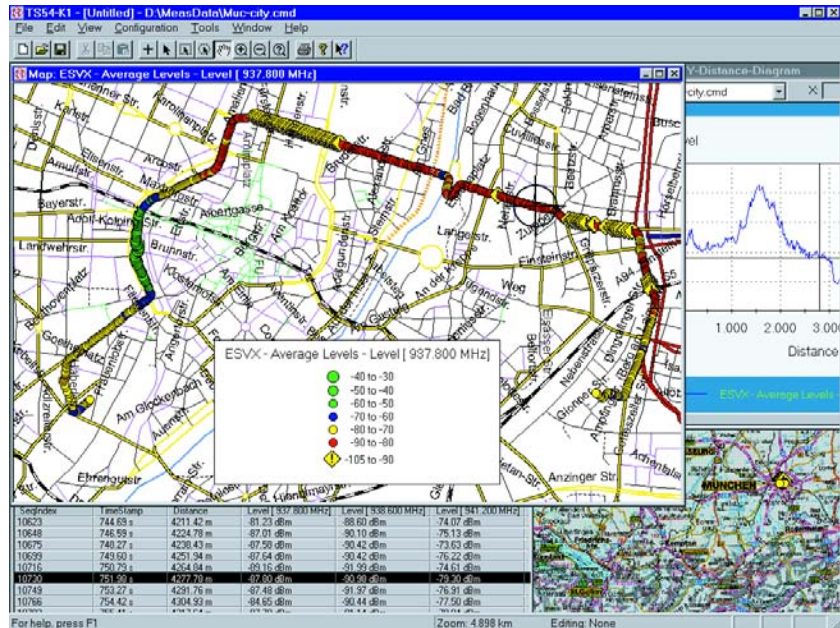

Graphical representation of RxLev and RxQual along a route

- ◆ Fast access to all local temporary data
- ◆ Freely definable legends and comments
- ◆ Selection and evaluation of multiple measurement files in database only limited by system resources
- ◆ Exact reference of measured points to the measurement device they originate from
- ◆ Statistical evaluation and area data mapping
- ◆ Wide range of attributes assignable to each signal (colour, icons, pattern, ranges) to get the most efficient visualization of parameters
- ◆ SQL (structured query language) data selection and evaluation
- ◆ User-definable derived signals
- ◆ Global data selection (interactive and SQL)

- ◆ No special expensive hardware is needed (recommended Pentium class 300 MHz or better)

### Available technologies

The most important digital network technologies and Test Receivers R&S®ESVx are supported.

- ◆ CW, Field-Strength Test Receiver R&S®ESVx
- ◆ GSM 900/1800/1900 test mobiles, signalling
- ◆ ETACS test mobile, signalling
- ◆ CDMA test mobile, signalling
- ◆ CIR (channel impulse response) analysis
- ◆ C/I (carrier/interference ratio)



Contents Overview

Chapter Overview

Type Index

R&S Addresses





Contents Overview

Chapter Overview

Type Index

R&S Addresses



## R&S®UMTS PN-Scanner

**Drive test equipment for network planning, design, installation, optimization, quality assurance and service**

### Brief description

The PN scanner is embedded in the modular software R&S®ROMES3. It consists of a dedicated driver, which has to be installed in the basic R&S®ROMES 3 software (see data sheet PD 0757.6679).

R&S®ROMES3 is based on a modular system concept, allowing any type of data to be collected and analyzed. Any sensor (e.g. test receiver, test mobile or GPS receiver) capable of result transfer to a PC or Laptop can be used. This opens a wide range of use, from measurements in mobile radio to almost any kind of exotic application. The modular concept enables the implementation of very small systems and high performance systems alike. And it makes the software future-proof, as it can easily be extended to accommodate up coming technologies.

### Main features

- ◆ Automatic PN code (node b) detection and analysis
- ◆ Signal strength measurement for different networks (UMTS, GSM, IS95, ...)
- ◆ Full spectrum analyzer function available
- ◆ Coverage measurement software R&S®Romes3 as a modular base
- ◆ Standard Test Receiver R&S®ESPI or Spectrum Analyzer R&S®FSP as RF front end
- ◆ GPS integrated
- ◆ Laptop or system controller application
- ◆ 120 dBm sensitivity



### R&S®UMTS PN-scanner can be configured to five packages

#### Laptop configuration for PN scanning

- ◆ Laptop equipped with PCMCIA IEEE bus interface or LAN interface (recommended)
- ◆ R&S®FSP (spectrum analyzer) or R&S®ESPI (test receiver)
- ◆ GPS system (e.g. Garmin mouse)
- ◆ Measurement software R&S®ROMES3 with PN scanner option

#### Laptop configuration for CW measurements

- ◆ Laptop equipped with PCMCIA IEEE bus interface or LAN interface
- ◆ R&S®ESPI (test receiver) with preselector
- ◆ GPS system (e.g. Garmin mouse)
- ◆ Measurement software R&S®ROMES3 with PN scanner option

#### Laptop configuration for CW measurements and PN scanning

- ◆ Laptop equipped with PCMCIA IEEE bus interface or LAN interface
- ◆ R&S®ESPI (test receiver)
- ◆ GPS system (e.g. Garmin mouse)
- ◆ Measurement software R&S®ROMES3 with PN scanner option

#### Process controller configuration for PN scanning

- ◆ Process Controller R&S®TSPC2 equipped with network interface
- ◆ External 15.1" LC display
- ◆ R&S®FSP (spectrum analyzer) or R&S®ESPI (test receiver)
- ◆ Inertial GPS navigation system
- ◆ Power supply control unit
- ◆ Measurement software R&S®ROMES3 with PN scanner option

#### High performance system for PN scanning and CW measurement

- ◆ System Process Controller R&S®TSPC2 equipped with network interface
- ◆ External 15.1" LC display
- ◆ R&S®ESPI (test receiver)
- ◆ Inertial GPS navigation system with distance trigger unit and external distance pulse generator
- ◆ Power supply control unit
- ◆ Measurement software R&S®ROMES3 incl. PN scanner and CW option

### Software user interface

A core unit is acting as a shunting station. It transfers the data from the external hardware via the driver to the result file and to the displays. In general two differ-



Contents Overview

Chapter Overview

Type Index

R&S Addresses



ent display types are supported, one is the general view e.g. 2 D-chart, alpha or map view, the other is the technical specific view, e.g. GSM measurement report, PN-Scan view etc. In addition post processing of our data with an external tool e.g. Excel is possible. A comfortable, freely definable export function and a lot of specific exports are also available. Upgrading to new hardware is easy. Only a new driver has to be installed by the user.

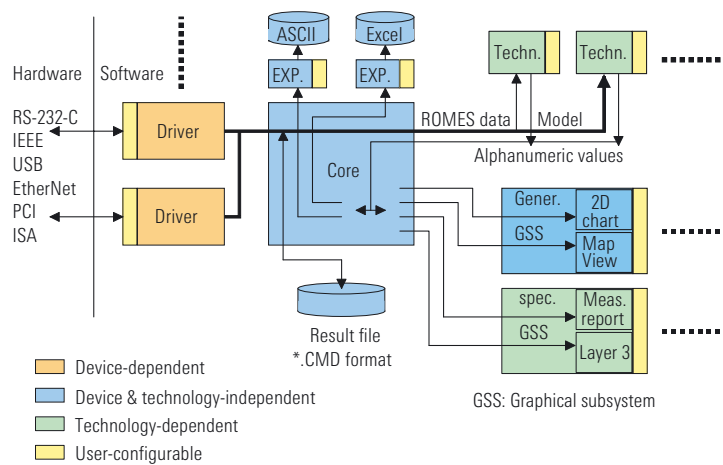

## Specifications

<b>General</b>	RSSI of received channel
<b>P-SYNC</b>	Graphical display of correlation result Relative power of detected peaks Time delay of detected peaks
<b>P-CPICH</b>	Code group Scrambling code Total power of CPICH Parameters per scrambling code

Result	Description	Specification
RSCP	Received signal code power	TS 25.215; 5.1.1
SIR	Signal to interference ratio	TS 25.215; 5.1.3
ISCP	Interference signal code power	TS 25.215; 5.1.3
$E_c/N_0$	The received energy per chip divided by the power density in the band	TS 25.215; 5.1.6
Parameters per identified peak per Scrambling Code		
Power	Power of identified peak	—
Time	Relative time of arrival	—

<b>Code channel power</b>	code channel power of code channels spreading factor
<b>Spectrum</b>	Spectrum of channel Spectrum History of channel

### Update rates

Update rates depend on three general aspects:

- ◆ Required measurements
- ◆ Number of node Bs and reflections in the air PC
- ◆ Performance

The following table represents typical update rates on a Pentium III 750 MHz System. The calculations were done with Version ROMES 3.16 and 15 UMTS Slots.

	Raw Data	P-SYNC	P-CPICH	Peaks	# Node Bs	Update [s]
Raw Data	✓	✓	✓	✓	✓	✓
P-SYNC		✓	✓	✓	✓	✓
P-CPICH			✓	✓	✓	✓
Peaks				✓	✓	✓
# Node Bs	—	4	1	4	1	4
Update [s]	0.7	0.9	1.2	1.5	1.4	1,8

### Dynamic Ranges

C-PICHs are analyzed successfully up to the following values:

$E_c/N_0$	-20 dB
RSCP	-100 dBm

## Ordering information

Laptop Configuration		
Laptop Computer	R&S®TS951PC	1070.5872.10
IEC625/IEEE-488 PCMCIA type II card	R&S®TS-IEC	1042.0970.02
GPS Navigation System	R&S®TS95GPS	1090.8348.02
EMI Test Receiver <sup>1)</sup>	R&S®ESPI3	1142.8007.03
Option preselector for R&S®ESPI <sup>2)</sup>	R&S®ESPI-B2	1129.7498.02
LAN Interface 10/100 BaseT for R&S®FSP/ESPI	R&S®FSP-B16	1129.8042.02
OCXO 10 MHz for R&S®FSP/ESPI	R&S®FSP-B4	1129.6740.02
Power Supply 12 V DC	R&S®TS-HW	1042.5771.02
Documentation of Calibration Values	R&S®DCV-2	0240.2193.09
Trigger for Coverage Measurements with R&S®FSP/ESPI3	R&S®ESPI-K50	1106.4386.02
CW Driver for R&S®ESPI	R&S®TS5K10E	1143.8198.02
Synchronization Unit for R&S®UMTS PN Scanner	R&S®TS-PNSY	1114.4817.00
R&S®ROMES3 R&S®UMTS PN Scanner Software Driver for UMTS	R&S®TS5-C50C	1063.0579.02
Basic Measurement Software R&S®ROMES3	R&S®TS5K00	1143.7991.02
Evaluation Software ROSEVAL	R&S®TS54-K1	1117.5495.02
UMTS High Performance System		
System Controller, LC-Display and Interfaces System Process Controller	R&S®TSPC2	4049.9571.00
High-performance GPIB Interface	R&S®TS-IEC	1042.1276.02
RS-232-C Interface <sup>3)</sup>	R&S®TS95SER	1029.5871.02
Network Adapter	R&S®TS95NET	1029.7997.02
15.1" TFT-Display	R&S®TS-LCD1	1064.5800.02
19" Rack for R&S®TS9955 (15 HU)	R&S®TS955RA	1053.5590.02
Measurement Cable Set for R&S®TS9955	R&S®TS955KS	1042.9631.02
Hardware Integration into rack for R&S®TS9955	R&S®TS955HI	1053.5603.02
All other options as in the Laptop configuration		

<sup>1)</sup> R&S®FSP can replace R&S®ESPI for PN Scan only, no CW use.

<sup>2)</sup> Factory installation only for R&S®ESPI.

<sup>3)</sup> For System Process Controller R&S®TSPC2.





## Radio Network Analyzer R&amp;S®TSMU

### UMTS PN Scanner Compact System (R&S®TSMU + R&S®TSMU-K1)



#### Brief description

Network installation and optimization work on 3GPP networks requires measurement tools that are increasingly smart, portable and powerful. The R&S®TSMU provides unmatched capabilities for network analysis and optimization.

When used in combination with software option R&S®ROMES-US2, the Radio Network Analyzer R&S®TSMU is a powerful instrument for UMTS interference analysis and network scanning on 3GPP networks.

The system consists of:

- ◆ Radio Network Analyzer R&S®TSMU
- ◆ Network Optimization Software R&S®ROMES
- ◆ Software driver R&S®ROMES-US2 for R&S®TSMU
- ◆ GPS with PPS pulse and/or synchronization unit for triggering (option)
- ◆ PC or notebook/tablet PC with IEEE 1394 interface

The Network Analyzer R&S®TSMU receives selective one UMTS channel, converts it continuously to a digital I/Q signal, prepares it independently of GPS position data and provides the temporary stored data to a FireWire interface.



*R&S®TSMU with a powerful notebook, GPS and UMTS test mobile*

The unit consists of three main components:

- ◆ High-quality RF frontend
- ◆ Processing unit with a platform FPGA and an embedded Motorola Power PC
- ◆ DC power supply unit

The digital IF data is transferred to the local 64 MB memory of the processing board. A separate and independent process transfers the digital IF data from the memory via an IEEE 1394 interface to the PC. Additional functions on the processor board control the settings of the RF frontend (RF attenuation, IF and RF amplification) evaluate the command frames from the PC and synchronize the time of the IF sampling data to the high precision pulse per second (PPS) signal of a global positioning system (GPS) receiver.

Every time the R&S®TSMU is switched on, the FPGA and the processor read out the configuration and boot code from a flash memory card.

The application firmware is to be loaded from R&S®ROMES via FireWire interface into the R&S®TSMU. To provide the R&S®TSMU with a new firmware version, only a new software driver is required.

#### Main features

- ◆ Easy, time-saving and high-precision UMTS coverage measurements and network optimization
- ◆ Handy, portable and compact solution (150 mm × 80 mm × 170 mm, 1.5 kg)
- ◆ Indoor/outdoor and autonomous solutions
- ◆ Multiband measurements up to 12 frequencies parallel
- ◆ GPS system with mapped measured values
- ◆ IEEE 1394 (FireWire) high-speed data interface to PC
- ◆ Low power consumption (typ. 8 W)
- ◆ Wide-range power supply 9 V to 18 V DC
- ◆ Standard processor platform, PCs or notebooks with Windows 2000/XP can be used





Contents Overview

Chapter Overview

Type Index

R&S Addresses



## Radio Network Analyzer R&S®TSMU

### GPS system (option)

A GPS system provides the position data for the measurement equipment or the measurement vehicle via GPS PPS signal. In case of small and portable solutions with notebook or tablet PC mostly a fully satellite supported GPS comes into operation.

#### GPS R&S®TS-GINA for highest precise measurements

During the measurement tours, e.g. through tunnels, sometimes the satellite signal is not available. Therefore Rohde&Schwarz offers the GPS R&S®TS-GINA for highest precise measurements.

If the satellite signal is missing, the system substitutes missing data dynamically by

- ◆ inertia sensor to recognize speed up, slow down and direction
- ◆ Peiseler pulse generator for the passed distance

### Application R&S®TSMU-K1 (option)

The final finish and presentation of the measurement data is performed by the Network Optimization Software R&S®ROMES. The software R&S®TSMU-K1 is an interface between R&S®TSMU and R&S®ROMES. The ROMES bundles run on a powerful PC, e.g. R&S®TSPC2, a notebook or for very compact solutions also on a tablet PC. An operating system Windows2000/XP and a Firewire or an USB interface are recommended.

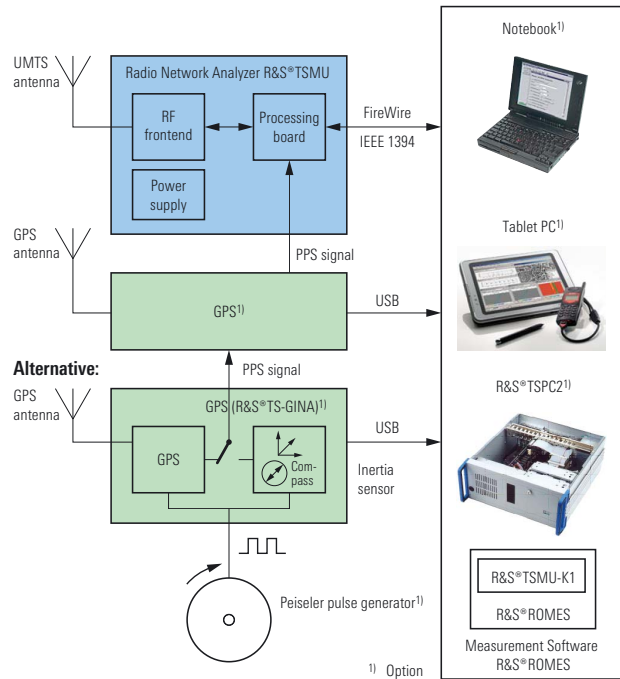

Block diagram of R&S®TSMU system

### Specifications in brief

You will find detailed and binding data on the enclosed CD (./DATASHEET/TSMU.pdf), or, for the latest updates, visit [www.rohde-schwarz.com](http://www.rohde-schwarz.com), search term: TSMU

### Ordering information

<b>Radio Network Analyzer</b>	R&S®TSMU	1153.6000.02
<b>Radio Network Analyzer</b>	R&S®TSMU-H	1153.6000.03
<b>Accessories supplied</b>		
Suitcase CD with handbook, application software		
Documentation „Getting Started“		
UMTS antenna with cable (1.5 m), adapter for UMTS antenna (SME to N, 1.5 m)		
Power supply cable with cigarette lighter connector		
IEEE 1394 cable (2 m)		
<b>Options</b>		
PN Scanner Software Package (includes ROMES Basic, GPS driver, export filter, indoor, NQA and TSMU PN Scanner driver)	R&S®TSMU-K1	1163.3010.02
CW Software Package (includes ROMES Basic, GPS driver, export filter, indoor, NQA and TSMU CW driver)	R&S®TSMU-K2	1163.3010.04
CW Measurement Software Upgrade Package for R&S®ROMES R&S®TSMU-K1	R&S®TSMU-KU2	1163.3010.06
Nokia 6650 UMTS Test Mobile Ext. (option for R&S®TSMU-K1: includes Nokia 6650 test mobile, test firmware, Nokia driver, car kit)	R&S®TSMU-Z10	1163.2995.02
Software Update Contract (for R&S®TSMU-K1 and R&S®TSMU-Z10, valid 1 year)	R&S®TSMU-ZU5	1163.3004.02
230 V AC/12 V DC Power supply	R&S®TSMU-Z1	1166.3786.02
19" Rack Adapter, 2 HU	R&S®TSMU-Z2	1153.6700.02
Extended Documentation of Calibration Values	R&S®DCV-2	0240.2193.15



Contents Overview

Chapter Overview

Type Index

R&S Addresses





Contents Overview

Chapter Overview

Type Index

R&S Addresses



## EMC Test Systems

**From small systems through to complete equipment of test houses with shielded anechoic chamber and the complete infrastructure required**

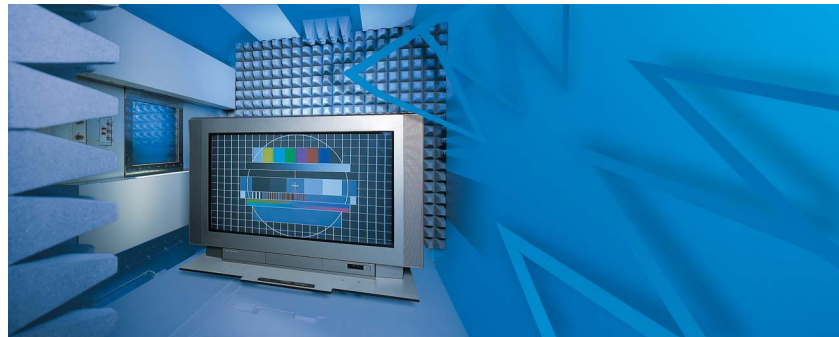

Planning and implementation of practice-oriented EMC test systems requires a great deal of specialized knowledge and experience. This is what Rohde& Schwarz specialists have. All their expertise goes into turnkey EMC test systems which provide the fastest way of yielding correct EMC measurements. These systems are

always tailored to the specific needs of the customer to provide the optimum solution to the tasks on hand. We can offer everything from small systems through to complete equipment of test houses with shielded anechoic chamber and the complete infrastructure required. Naturally, the main emphasis is on fully

automatic measurements with comprehensive documentation of the test results and, if desired, statistical evaluation. One of the important factors of automatic EMC test systems is calibration and continuous monitoring of the measurement accuracy to make sure that all test results will pass another compliance test.

### System overview

Type	Description	Application	Special	Page
R&S®TS9970	RF Performance Test System	Measuring main RF parameters of wireless communication equipment under realistic operating conditions	Common RF	356
R&S®TS9975	EMI Test System	EMI measurements of conducted and radiated interference	Commercial, military	358
R&S®TS9976	Emission Test System	EMI and spurious emission measurements on wireless communication equipment during EMC and type approval testing	Conducted, radiated	359
R&S®TS9980	EMI Test System	EMS measurements on sound broadcast and TV receivers, satellite receivers and DVB receivers; automatic and objective picture assessment in susceptibility tests	EN55020 or CISPR20	361
R&S®TS9981	EMS Test System	Measurement of susceptibility to electromagnetic fields	IEC61000-4-3, EN61000-4-3 and other standards	363
R&S®TS9986	EMS Test System	measurement of susceptibility to conducted interference	IEC61000-4-6 and other standards	365
R&S®TS998xM	EUT Monitoring System	Monitoring of the equipment under test for proper functioning during EMS measurements	For R&S®TS9981 and R&S®TS9986	366
R&S®TS9994	EMC Test System	Modular EMC solution for development of car components	Immunity (EMS) 9 kHz to 2.5 GHz, up to 200 V/m, emissions (EMI) 9 kHz to 3 GHz	367
R&S®TS-EMF	Portable System for EMF Measurement	Accurate measurements of electromagnetic fields caused by transmitter systems		368
R&S®EMS-K1	EMS Software	Basis for the automatic control and monitoring of EMS test systems and for the acquisition and analysis of measurement data	Universal EMS software package that can be used for just about any measurement method	370
R&S®EMON-K1	CAN-Bus Monitoring	CAN-bus monitoring when performing EMS measurements with R&S®EMS-K1		372
R&S®EMC32, R&S®EMC32-E+	EMC Software EMI Software	For use in development, for compliance and batch testing For manual and automated EMI measurements		80 82



Contents Overview

Chapter Overview

Type Index

R&S Addresses





Contents Overview

Chapter Overview

Type Index

R&S Addresses



## RF Performance Test System R&S®TS9970

RF parameter measurements  
on communication equipment

### Brief description

#### Uses

Test System R&S®TS9970 has been designed for measuring main RF parameters of wireless communication equipment under realistic operating conditions. In addition to the spatial radiation characteristic of the communication antenna, receiver parameters such as signal-to-noise ratio and bit error rate as a function of EUT orientation can be determined.

R&S®TS9970 can be effectively used both in design and type approval testing.

#### Configuration

As shown in block diagram, R&S®TS9970 is made up of the following main components:

- ◆ The communication tester in conjunction with the communication antenna serves for establishing a radio link to the EUT
- ◆ Depending on the type of measurement to be performed, the measurement antenna is connected via a switch matrix either to the spectrum analyzer, RF generator or communication tester

- ◆ The EUT is mounted on a positioning device which is remote-controlled by a controller. An artificial head or body may be used to simulate the operator's influence
- ◆ A central process controller including the appropriate software provides for automatic measurements with documentation of results
- ◆ To simulate open area conditions, a shielded anechoic chamber is required for testing

### Main features

- ◆ Determination of spatial radiation and receiving characteristics of EUT
- ◆ Especially suitable for EUTs with integrated antenna
- ◆ Measurement of main RF parameters via air interface
- ◆ Automatic measurements and analysis of results
- ◆ Also available as extension for EMC lab systems

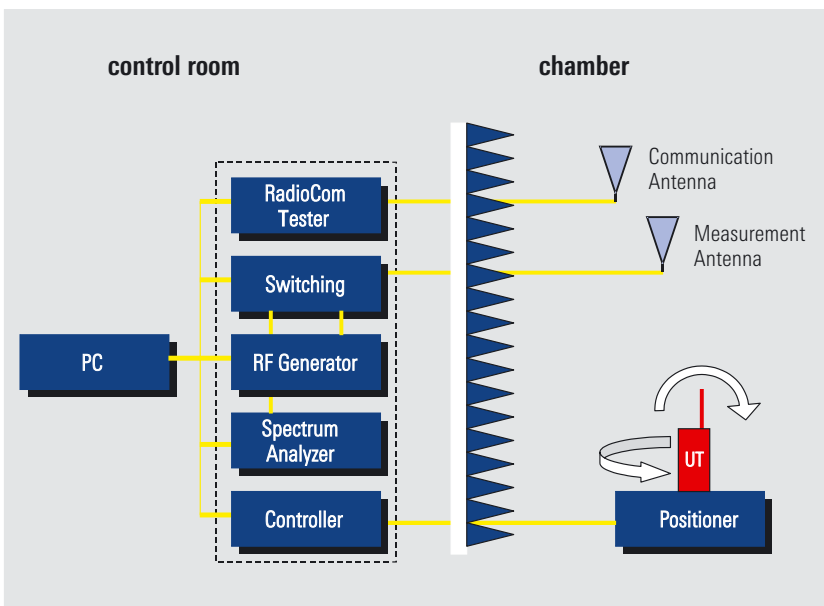

Block diagram R&S®TS9970



Contents Overview

Chapter Overview

Type Index

R&S Addresses





Contents Overview

Chapter Overview

Type Index

R&S Addresses



## RF Performance Test System R&S®TS9970

### System versions

#### Version 01 – Basic system

##### Main components

- ◆ Signal generator
- ◆ Spectrum analyzer
- ◆ Positioning device
- ◆ Communication tester
- ◆ Relay matrix
- ◆ RF attenuator
- ◆ Test and communication antennas
- ◆ System software

#### Version 02 – Extension for EMV systems

Since existing EMC systems often contain most of the instruments used in the R&S®TS9970 basic system, version 02 is available for extending such systems. Rohde&Schwarz offers an upgrade package tailored to the specific needs.

##### Standards

Almost any digital and analog radio standard can be implemented in the system. A suitable communication tester is the only prerequisite. Rohde&Schwarz testers support the following standards:

- ◆ TACS, AMPS
- ◆ GSM900/1800/1900
- ◆ DECT
- ◆ CDMA, D-AMPS
- ◆ Bluetooth®
- ◆ GPRS, EDGE
- ◆ UMTS

Implementation of Universal Communication Tester R&S®CMU into the R&S®TS9970 is also possible. Configurations for other standards on request.

##### Test parameters

- ◆ Bit error rate
- ◆ Effective radiated power (ERP) or equivalent isotropically radiated power (EIRP)
- ◆ Transmission parameters such as RXQUAL, RXLEV, etc
- ◆ S/N ratio at receiver input, etc

### System software

#### Main features

- ◆ Standard test routines for measurement of 3D directional pattern in a spherical or semispherical volume
- ◆ Standard test routines for measurement of 2D directional pattern (azimuth pattern)
- ◆ Setting of all test parameters via the software user interface
- ◆ Automatic evaluation of results (referred to limit values, e.g. conforming to GSM, DECT, etc)
- ◆ Graphical and tabular display of results
- ◆ Automatic generation of test reports
- ◆ Expandable for magnitude and phase measurements (network analyzer)

### Specifications

Operating temperature range	+15°C to +40°C
Relative humidity	95% at 40°C
Power supply	110 V AC, 230 V AC
Certification	CE, VDE
The system comes in a 19" rack	

### Accessories

Controller	R&S®TS-PCS
Artificial head	R&S®TS-HEA
Artificial body	R&S®TS-BOD



Contents Overview

Chapter Overview

Type Index

R&S Addresses





Contents Overview

Chapter Overview

Type Index

R&amp;S Addresses



## EMI Test System R&S®TS9975

### EMI measurements of conducted and radiated interference

#### Brief description

EMI Test System R&S®TS9975 is used for all EMI measurements of conducted and radiated interference.

#### Commercial standards

- ◆ CISPR 11–22
- ◆ EN 55011–55022
- ◆ VDE 0872–0879
- ◆ ANSI-C63.4
- ◆ FCC 15, 18
- ◆ EACL 1–8

#### Military standards

- ◆ VG95370–95377
- ◆ DEF-STAN 49–41
- ◆ GAM-EG 13
- ◆ MIL-STD-461/462

Customer-specific adaptations to other standards or different regulations can be integrated into Test System R&S®TS9975 without any problems.

#### System configuration

The system features a highly modular hardware and software concept. Customized systems can be configured from a variety of instruments and software options. The system is a complete package of hardware and user-friendly software as well as system services so that the user will be familiar with the system within the shortest possible time.

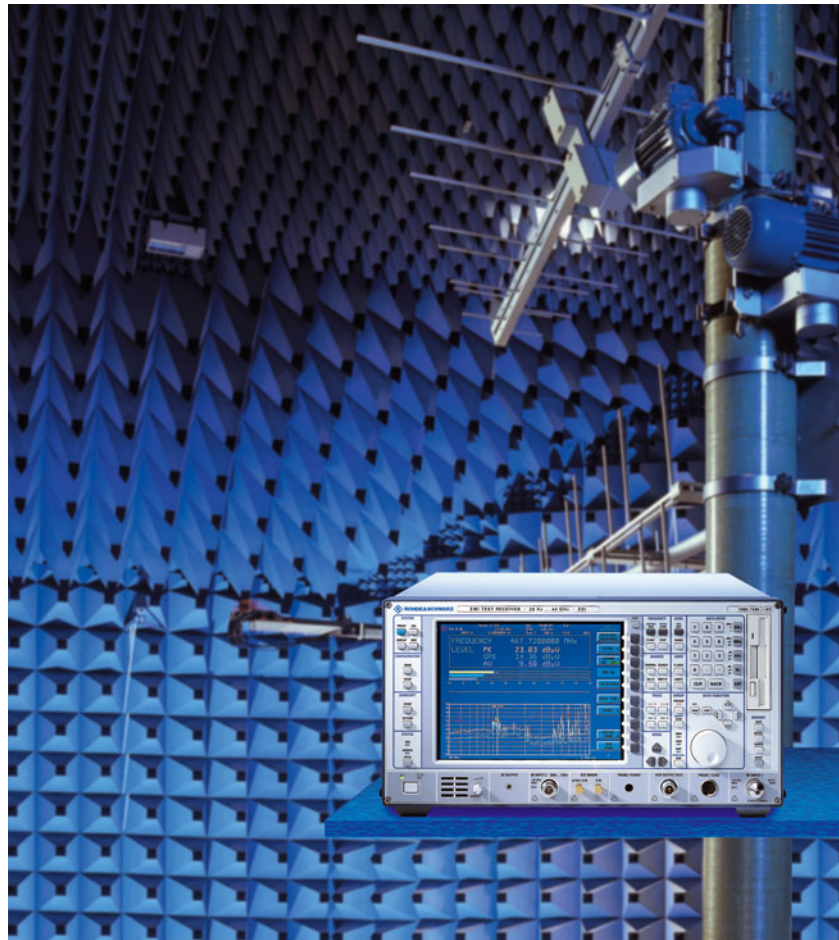

#### Hardware

A Process Controller (PC) is the core of the system; it controls the complete measurement system via its IEC/IEEE bus interface. Depending on the frequency range to be covered and the special test requirements, measurements are carried out by one or several test receivers.

#### Hardware expansions

- ◆ Artificial Mains Networks  
R&S®ESH2-Z5 and R&S®ENV216
- ◆ System Control Unit R&S®TS-RSP for switching antennas and transducers
- ◆ Rohde&Schwarz test antennas  
(i.e. R&S®HL562)

Moreover, Rohde&Schwarz can offer the integration of products from other manufacturers into Test System R&S®TS9975, if required.

#### Software concept

EMI Software R&S®EMC32 is used in EMI Test System R&S®TS9975.



Contents Overview

Chapter Overview

Type Index

R&amp;S Addresses





Contents Overview

Chapter Overview

Type Index

R&amp;S Addresses



## Emission Test System R&S®TS9976

Fully automatic emission  
measurements on wireless  
communication equipment

### Brief description

#### Applications

System R&S®TS9976 is used for EMI and spurious emission measurements on wireless communication equipment during EMC and type approval testing. Typical DUTs are mobile phones, base stations, radio sets and short-range devices.

#### Relevant standards

Measurements of this type are based on the standards and technical regulations published by ETSI (European Telecommunications Standards Institute). For example, EMC measurements on GSM systems are defined by ETS301489-7, measurements of spurious emissions by ETS300-607 (GSM11.10), ETS300-609 (GSM 11.20) and by TBR 5 and 9 (technical basis for regulation). ETS301489-7 provides the generic standard for the EMC of radio equipment.

#### Specified emission measurements

The above standards stipulate a wide variety of measurements in a very wide frequency range, all of which can be covered with R&S®TS9976:

- ◆ Conducted EMI measurements from 0.15 MHz to 30 MHz in line with EN55022
- ◆ Radiated EMI measurements from 30 MHz to 1000 MHz in line with EN55022
- ◆ Conducted spurious emission measurements from 100 kHz to 12.75 GHz on antenna connector of DUT
- ◆ Radiated spurious emission measurements from 30 MHz to 4 GHz

For some radiocommunication systems (e.g. short-range devices), higher frequency limits (e.g. 40 GHz) are already stipulated for spurious emission measurements. R&S®TS9976 can be modified accordingly to accommodate for this requirement.

Spurious emission measurements differ from EMI measurements to EN55022 mainly in that bandwidths matching the useful signal have to be set on the receiver instead of the typical EMC bandwidths (e.g. 200 Hz, 9 kHz, 120 kHz). It should also be noted that EMC bandwidths are referred to the 6 dB points of the IF filters, whereas the bandwidths for spurious emission measurements are referred to the 3 dB points. In spurious emission measurements, the peak detector takes the place of the quasi-peak detector. All these differences make it necessary that for spurious emission measurements a spectrum analyzer or test receiver with spectrum analyzer functionality be used rather than a pure EMC test receiver. In addition to EMI and spurious emission measurements, R&S®TS9976 can also measure useful signals, for example the EIRP (equivalent isotropically radiated power) of radio sets and modules with integrated antenna.



Contents Overview

Chapter Overview

Type Index

R&amp;S Addresses





Contents Overview

Chapter Overview

Type Index

R&S Addresses



## Emission Test System R&S®TS9976

### Main features

- ◆ Frequency range 0.15 MHz to 18 (40) GHz
- ◆ EMC measurements to IT standards (e.g. EN55022, FCC)
- ◆ Use in type approval testing (e.g. for GSM to ETS300-607/609)
- ◆ Measurement of spurious emissions from radiocommunication equipment

### System design

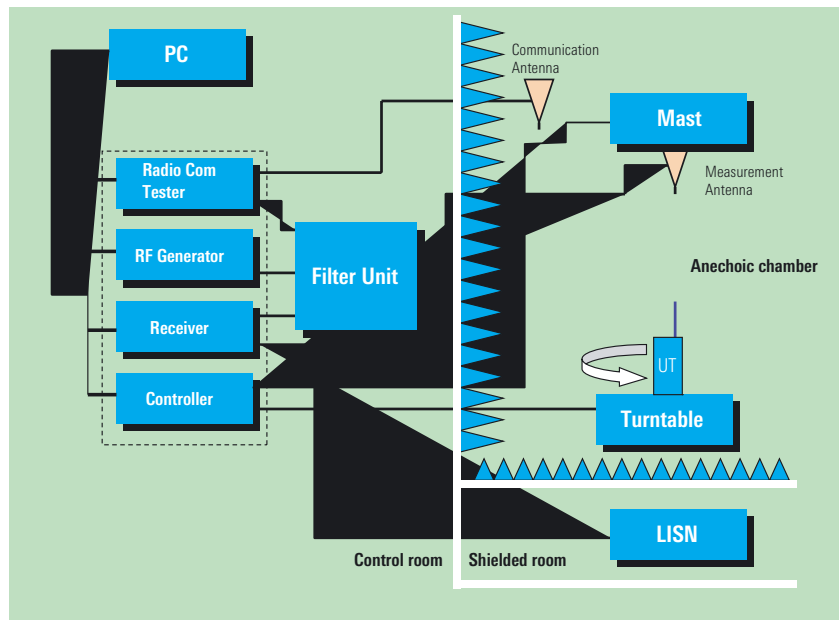

Block diagram R&S®TS9976

#### Test receiver

The test receiver forms the core of the system. As a typical EMC test receiver, it evaluates and displays emissions from 0.15 MHz to 1000 MHz in line with EN55022 and, in addition, it offers spectrum analyzer functionality for spurious emission measurements. If only the spurious is to be measured and if precompliance measurements are sufficient for EMC testing, a spectrum analyzer can be used instead of the test receiver.

#### Anechoic chamber

Radiated emissions are measured in an anechoic chamber. For this, a remote-controlled turntable and an automatic antenna mast with a control unit are required. These components can optionally be supplied with the system and controlled by the system software.

#### Test antennas

Suitable test antennas (usually log-periodic or horn antennas) and artificial mains networks are used for picking up emissions.

#### Filter unit

To measure spurious emissions, for example of mobile phones, in line with standards at a sufficiently wide dynamic range also with the DUT transmitting, the useful signal emitted by the DUT must be suppressed by means of bandstop or highpass filters.

To this effect, Rohde&Schwarz developed a special filter unit which, thanks to its flexible design, satisfies the common mobile radio standards (GSM900, GSM 1800, DECT, CDMA, etc) and at the same time meets customer-specific requirements.

#### Communication tester

To switch the DUT to a defined operating state, a communication link has to be set up. This is done by a communication tester integrated in the system.

#### Signal generator

The signal generator is needed for system calibration and for substitution measurements which are prescribed by some standards.

#### Controller

The system components are controlled from a PC via the IEC/IEEE bus using EMI Software R&S®ES-K1.

#### Software

The control software R&S®ES-K1, which forms part of the system, enables fully automatic simple testing. The complete software package runs on a PC or PC-compatible industrial controller. The system components are driven via the IEC/IEEE bus interface.



Contents Overview

Chapter Overview

Type Index

R&S Addresses







Contents Overview

Chapter Overview

Type Index

R&S Addresses



## EMS Test System Audio and Video R&S®TS9980



### EMS measurements on sound and TV broadcast receivers, satellite and DVB receivers

#### Brief description

The Test System R&S®TS9980 has been designed for automatic measurement of the electromagnetic susceptibility of sound and TV broadcast receivers to EN55020 and CISPR20.

#### The following measurements are covered:

- ◆ Input immunity (S1)
- ◆ Immunity to conducted voltages (S2a)
- ◆ Immunity to conducted currents (S2b)
- ◆ Immunity to radiated fields (S3)
- ◆ Shielding effectiveness (S4)

As part of ongoing technical development, system solutions for satellite receivers, DVB receivers and set-top boxes have been implemented. Particu-

larly noteworthy is the new TV-MON option for automatic, objective picture assessment of video signals and monitor test pictures (recorded with TV-CAM). The Test System R&S®TS9980 can be used for precompliance measurements, compliance measurements and batch testing.

#### R&S®TS9980 Audio

The basic system R&S®TS9980 Audio (R&S®TS9980 A) is suitable for testing all analog sound broadcast receivers, tuners, amplifiers, equalizers, CD players, tape decks and accessories. The basic system R&S®TS9980 Audio covers the following broadcast standards:

- ◆ FM: VHF (mono/stereo)
- ◆ AM: LF/MF/HF (mono)

#### R&S®TS9980 AV Multistandard

The enhanced R&S®TS9980 AV Multistandard System (R&S®TS9980 AV-M) is suitable for all relevant EMS measurements on analog sound and TV broadcast

receivers and video recorders. The following TV standards are covered:

- ◆ PAL: B/G, I, D/K
- ◆ SECAM: D/K, L/L'
- ◆ NTSC: M/N

The relevant audio standards mono, dual sound, NICAM and BTSC (mono) are supported.

#### R&S®TS9980 DVB Multistandard

The full-featured R&S®TS9980 DVB Multistandard System (R&S®TS9980 DVB-M) is suitable for all relevant EMS measurements on analog and digital sound and TV broadcast receivers, as well as on video recorders and set-top boxes (integrated receiver decoders). In addition to the analog TV standards, the following digital standards are covered:

- ◆ DVB-C QAM (quadrature amplitude modulation) to ETS300429
- ◆ DVB-S QPSK (quadrature phase shift keying) to ETS300421



Contents Overview

Chapter Overview

Type Index

R&S Addresses





Contents Overview

Chapter Overview

Type Index

R&S Addresses



- ◆ DVB-T OFDM (orthogonal frequency division multiplex) to ETS300744
- ◆ ATSC 8VSB (vestigial sideband) to ATSC Doc. A/53

### Option R&S®TV-MON

The System Extension R&S®TV-MON allows for the first time fully automatic and objective picture assessment in susceptibility tests on TV receivers and associated equipment, independent of the subjective perception of the viewer. This is a special advantage in the very time-consuming and repetitive procedures required for batch testing and compliance measurements. R&S®TV-MON identifies analog as well as digital picture degradations using objective picture assessment, based on an algorithm-oriented comparison with a reference picture. For equipment under test (EUT) without integrated monitor (e.g. video recorders, set-top boxes), the reference and test pictures at the EUTs video output (CCVS) are used. For EUTs with monitor (e.g. TV sets, monitors) the test pictures are recorded with a video camera system (TV-CAM) available as an option.

### System Software R&S®T80-K1

System Software R&S®T80-K1 runs under Windows 9x/NT/2000/XP. The integrated

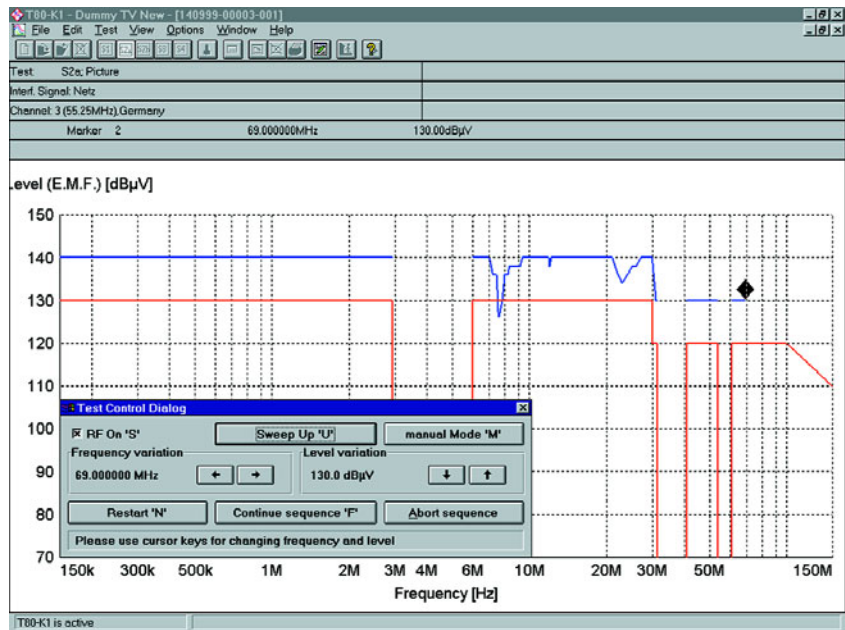

DDE interface allows data exchange between various Windows programs. Each test result is stored together with the test parameters. The test parameters contain all definitions of the test configuration. Due to the joint storage of test results and parameters, any measurement performed can be repeated with exactly the same settings – even a long time afterwards. With the modular options, the software can easily be upgraded to meet future requirements.

The software packages are protected by passwords and various user levels.

### DVD Compendium Professional R&S®TestDVD

In many cases, measurement quality is determined to a considerable extent by the scope and quality of the available test signals. The DVD compendium offers a unique compilation of many different video and audio streams for professional applications (see page 140).

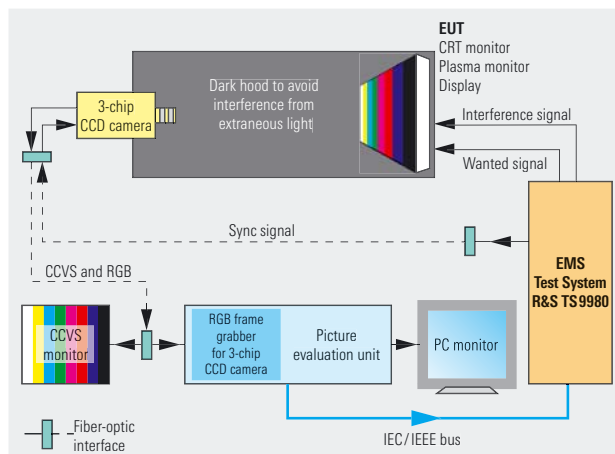

**Principle of objective picture quality assessment of TV receivers using R&S®TV-MON and R&S®TV-CAM**

### Software options

#### R&S®T80-K4A (option for R&S®TV-MON)

Control software for R&S®TV-MON for objective picture assessment of analog EUTs.

#### R&S®T80-K4D (option for R&S®TV-MON)

Control software for R&S®TV-MON for objective picture assessment of analog and digital EUTs.

#### R&S®T80-K5 (video upgrade)

Upgrade for EMS testing of analog TV broadcast receivers and video recorders.

#### R&S®T80-K6 (audio upgrade)

Upgrade for EMS testing of sound broadcast receivers.

#### R&S®T80-K7 (DVB upgrade)

Upgrade for EMS testing of satellite and DVB/ATSC TV broadcast receivers.

#### R&S®T80-K13 (option S4)

Measurement of shielding effectiveness of sound and TV broadcast receivers.



Contents Overview

Chapter Overview

Type Index

R&S Addresses





Contents Overview

Chapter Overview

Type Index

R&S Addresses



## EMS Test System R&S®TS9981

### EMS measurements to

### IEC61000-4-3/EN61000-4-3

### Brief description

With the European standards for electromagnetic compatibility and the relevant national EMC laws that came into effect, EMS tests on electrical and electronic equipment are required in all areas of the civilian sector.

The test procedure for determining susceptibility to electromagnetic fields is described in the international standard IEC61000-4-3. In Germany, standard VDE0843, Part 3 was derived from this standard. Product-specific European standards (EN61000-4-3) based on valid national and international standards have been established. Test System R&S®TS9981 is for automatic EMS testing to IEC61000-4-3 and EN61000-4-3 with field strengths of  $\geq 10$  V/m in the frequency range 80 MHz to 2.5 GHz. On demand the frequency range is expandable up to 3 GHz, 18 GHz or 40 GHz. Hereby an efficient, flexible and reliable tool both for tests in development and acceptance tests is available.



### Main features

Automatic measurement of susceptibility to electromagnetic fields to IEC61000-4-3, EN61000-4-3 and other standards

- ◆ Measurements at all severity levels with test field strengths  $\geq 10$  V/m
- ◆ High accuracy and reproducibility of results
- ◆ Short preparation and test times with powerful software under Windows9x/NT4.0/2000/XP
- ◆ Automatic generation of detailed test reports
- ◆ Efficient test routines
- ◆ User-friendly operation

### System configuration

System R&S®TS9981 includes an EMS control unit, an amplifier, a transmitting antenna and a field probe. The system is fully computer-controlled (PC). This makes for reproducible and largely automatic test sequences.

The EMS control unit comprises a signal generator, a field strength meter, a power meter, and a directional coupler unit. The broadband power amplifier used in the system covers the whole frequency range from 80 MHz to 2.5 GHz.

To generate electromagnetic fields, Log-Periodic Antenna R&S®HL046E is used for the frequency range from 80 MHz to 2.5 GHz. EMS tests can be performed without changing the antenna, thus avoiding time-consuming interruptions.



Contents Overview

Chapter Overview

Type Index

R&S Addresses





Contents Overview

Chapter Overview

Type Index

R&S Addresses



## EMS Test System R&S®TS9981

### Software

Test System R&S®TS9981 comes with the System Software R&S®EMC32 for Windows (see chapter 2, page 80). The software makes it possible to carry out automatic EMS measurements to all relevant standards. R&S®EMC32 is a convenient, cost-effective and reliable tool, enabling fast and easy system operation and high throughput. The extended test and configuration capabilities ensure high reproducibility of results.

### Expandability

Test System R&S®TS9981 is of modular design and can be extended by options. Various configuration levels allow for further automation of the test system, so giving an even higher throughput.

#### Optional components include

- ◆ EUT Monitoring System  
R&S®TS9981M (see page 366)
- ◆ Components and accessories for remote-controlled amplifier in separate room
- ◆ Shielded anechoic chambers
- ◆ TEM/GTEM cells

### Overview of models

Model	Main applications	Technical features
R&S®TS9981A	Favourably priced test system for development labs, EMC labs and test houses; compliance tests with field strengths according to selected amplifier output power	Generator R&S®SML03, Power Meter R&S®NRVS for measurement of forward power; EMS control unit designed as a 19" desktop; amplifier power depends on desired field strength
R&S®TS9981B	Expandable test system for EMC labs (quality management) and test houses	Same as R&S®TS9981A, but with EMS control unit designed as a 19" rack; measurement of forward and reflected power with R&S®NRVD

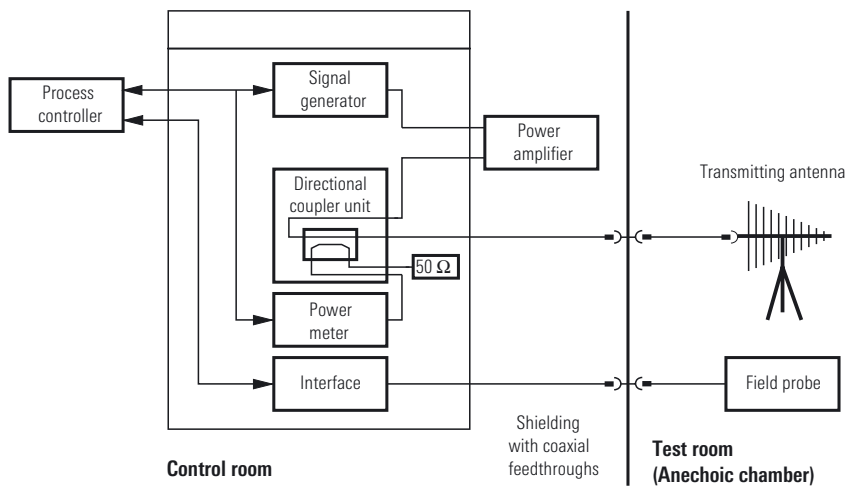

Block diagram R&S®TS9981



Contents Overview

Chapter Overview

Type Index

R&S Addresses





Contents Overview

Chapter Overview

Type Index

R&S Addresses



## EMS Test System R&S®TS9986

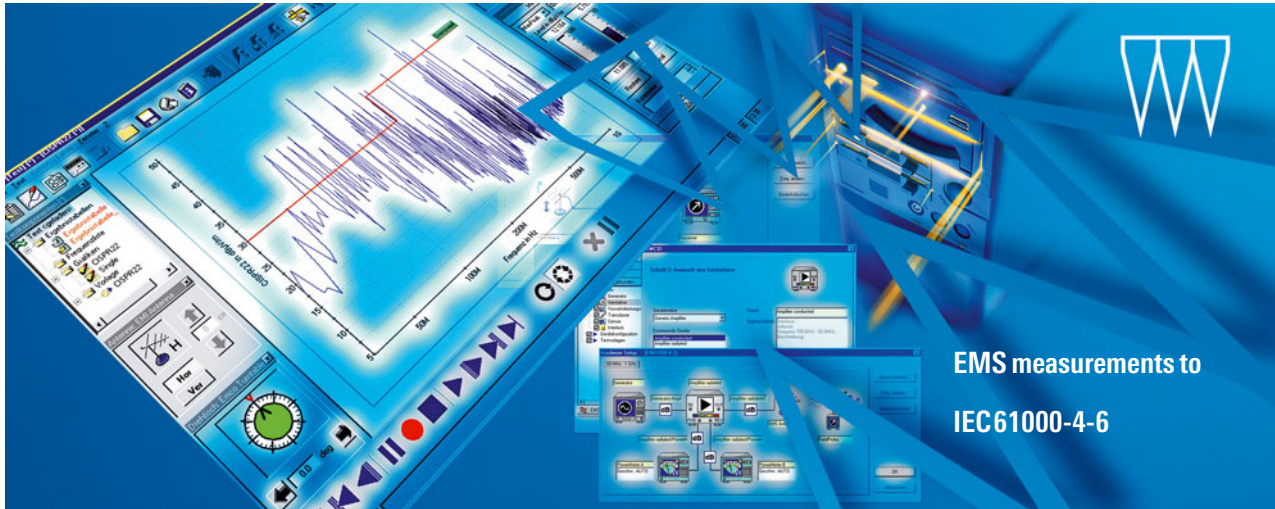

EMS measurements to IEC61000-4-6

### Brief description

With the new European standards for electromagnetic compatibility and the relevant national EMC laws that came into effect, EMS tests on electrical and electronic equipment are required in all areas of the civilian sector. The test procedure for determining susceptibility to conducted RFI is described in the international standard IEC61000-4-6. In Europe, a corresponding EN standard was derived from this standard (EN61000-4-6).

Test System R&S®TS9986 enables automatic EMS testing to IEC61000-4-6 with severity levels of up to 10 V in the extended frequency range 150 kHz to 230 MHz. It is an efficient and reliable tool both for tests in development and acceptance tests.

### Main features

- ◆ Automatic measurement of susceptibility to conducted interference to IEC61000-4-6 and other standards
- ◆ High accuracy and reproducibility of results

- ◆ Short preparation and test times with powerful software under Windows
- ◆ Efficient test routines
- ◆ Automatic generation of detailed test reports
- ◆ User-friendly operation

### System configuration

System R&S®TS9986 includes a signal generator, a power amplifier and a power meter. The system is fully computer-controlled (PC) via the IEC/IEEE bus. This makes for reproducible and largely automatic test routines.

### Software

Test System R&S®TS9986 comes with the System Software R&S® EMC32 for Windows (see chapter 2, page 80). The software makes it possible to carry out automatic EMS measurements to all relevant standards. R&S®EMC32 is a convenient, cost-effective and reliable tool, enabling fast and easy system operation and high throughput. The extended test and configuration capabilities ensure high reproducibility of results.

### Expandability

Test System R&S®TS9986 comes in different configuration stages plus an option for automatic EUT monitoring. One or several different coupling/decoupling networks may be required in addition to the R&S®TS9986 basic system configuration depending on the type and number of connections to the EUT. Further accessories including a computer desk, a wooden test bench with a copper surface, and feedthroughs for shielded walls are available to yield a system tailor-made to customer's requirements.

### EMS Test System R&S®TS9982

#### EMS measurements to IEC61000-4-3/6

This system is a combination of Test Systems R&S®TS9981 and R&S®TS9986, allowing EMS measurements in line with IEC61000-4-3 and IEC61000-4-6. It is a favourably priced alternative for users performing measurements in line with both standards.



Contents Overview

Chapter Overview

Type Index

R&S Addresses





## EUT Monitoring Systems R&S®TS998xM

### EUT monitoring for Test Systems

#### R&S®TS9981 and R&S®TS9986

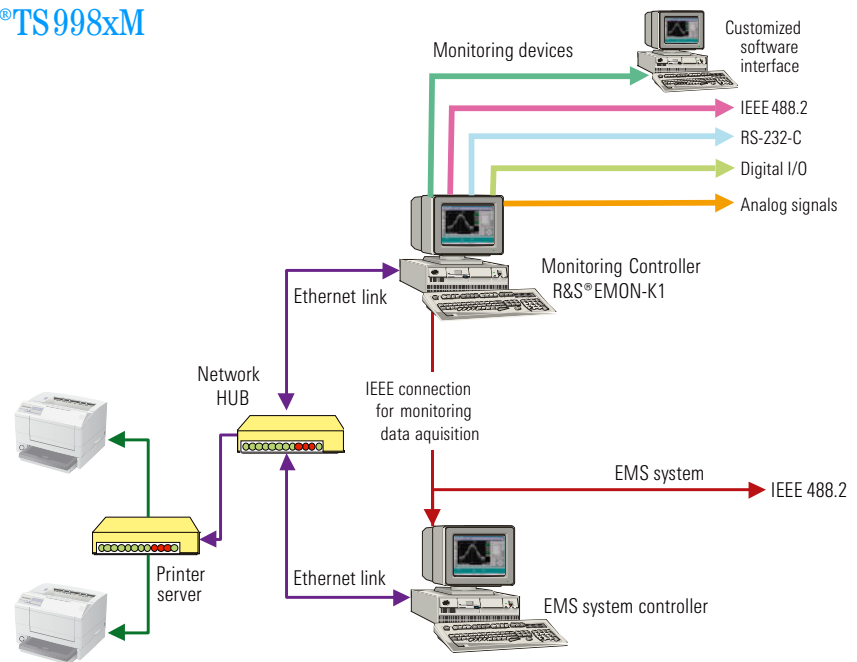

### Brief description

EUT (Equipment under Test) Monitoring System R&S®TS998xM is used for automatic monitoring of the equipment under test for proper functioning during EMS measurements. If the EUT does not function properly during the measurement, the field strength is reduced until the EUT resumes correct operation. The field strength is then increased until the EUT shows signs of malfunctioning or the nominal field strength is reached.

### System configuration

The above block diagram shows an example of the system functionality. The EUT monitoring system is an option for the EMS test system.

- ◆ Various interfaces are available for evaluating and stimulating the EUT
  - Digital I/O signals
  - Analog signals
  - A/D inputs
  - Output of frequency-proportional voltage

- ◆ Various interfaces for driving measuring instruments
  - IEEE488.2
  - TCP/IP
  - USB
  - RS-232-C
- ◆ Large number of drivers available, e.g.
  - DMMs
  - Oscilloscopes
  - Spectrum analyzers
  - Communication testers
  - Signal generators
  - Power meters
- ◆ Simple driving of other devices, including customer-specific devices, via generic drivers
- ◆ Monitoring and stimulation of complex EUTs via software interface. Existing programs can be included in the monitoring program by integrating a communication routine in the customer software
- ◆ Visual monitoring via video capture system. In addition to the storage of images, this system allows automatic monitoring of analog and digital displays in the case of EUT malfunctioning

Solutions for other special monitoring applications (e.g. CAN bus monitoring, see page 372) are available.

### Software concept

Three different concepts are used for monitoring:

- ◆ Direct control of the devices with recording of any number of independent channels
- ◆ Use of an independent controller communicating with the EMS measurement software
- ◆ Device control via R&S®EMON-K1 or R&S®EMC32-S on the system controller or on a separate monitoring controller with the possibility of frequency-asynchronous or frequency-synchronous measurement

In all these cases optimum protection of the EUT is ensured by the definition of switch-off criteria.





Contents Overview

Chapter Overview

Type Index

R&S Addresses



## EMC Test System R&S®TS9994

**Modular EMC solution for  
development of car components**

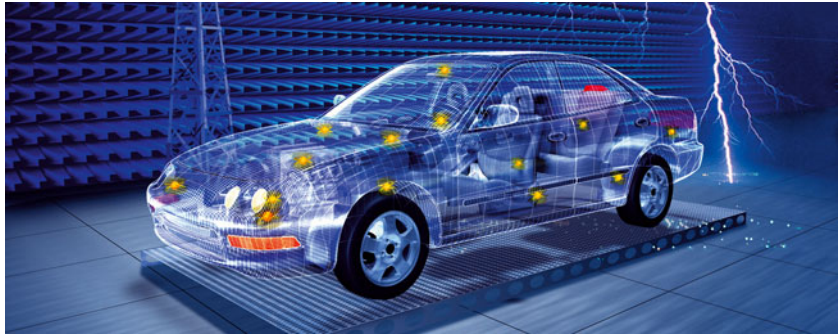

### Brief description

#### Introduction

Due to the increase in electronic sub-assemblies inside cars, EMC testing is essential for the development of car components. EMC testing throughout the R&D process with compact and local test systems reduces the time to market as well as the risk of subsequent, expensive product modifications.

#### Main features

- ◆ In line with all relevant automotive standards
- ◆ Modular system design
  - Different modules available
  - Open-ended for future requirements
  - Upgradable to full conformance test system
- ◆ Ideal for R&D laboratories
  - Compact system design
  - No special infrastructure required
- ◆ Immunity (EMS) 9 kHz to 2.5 GHz, up to 200 V/m
- ◆ Emissions (EMI) 9 kHz to 3 GHz
- ◆ Conducted and radiated measurements
- ◆ Covering current and future wireless bands
- ◆ Ready-to-use solution
- ◆ Test Software R&S®EMC32
  - Graphic operating concept (virtual instrument)
  - Intuitive user guidance

#### Efficiency

The preconfigured and completely tested R&S®TS9994 system in combination with the Rohde&Schwarz installation on site guarantees the customer a ready-to-use EMC system. All necessary system accessories (e.g. for calibration) are included.

This system can be installed where it is most efficient, since it features the following benefits:

- ◆ GTEM cell
- ◆ No need for shielded environment
- ◆ Low acoustic noise of whole test system
- ◆ Compact system design
- ◆ No additional infrastructure required

Training on the system plus the Rohde&Schwarz support including hot-line increase the efficiency and reliability of the system even more.

#### Applicability

The Test System R&S®TS9994 has been designed to perform measurements in line with the frequency ranges and limits specified in the following standards for car components:

ISO 11452, CISPR25 and SAE J1113.

Due to its modular design, the R&S®TS9994 can be upgraded to a conformance test system at a later stage.

#### Flexibility

Customers have a choice of different system levels according to their requirements:

Level	Description
1	Radiated emission (EMI) 9 kHz to 3 GHz
2	Emission (EMI) Radiated 9 kHz to 3 GHz Conducted 10 kHz to 108 MHz
3	Radiated susceptibility (EMS) 9 kHz to 1 GHz
4	Susceptibility (EMS) Radiated 9 kHz to 1 GHz Conducted 1 MHz to 400 MHz (BCI)
5	Radiated + conducted EMC Combination of levels 2 and 4
6	Radiated susceptibility (EMS) 1.7 GHz to 2.5 GHz Extension for level 4 or 5

Level 6 is an extension for EMS testing of current and future wireless services (GSM, UMTS, *Bluetooth* etc) in the GHz range.

#### Easy-to-use Test System Software R&S®EMC32

The intuitive control software, which is an integral part of the system, enables manual and fully automatic testing. For detailed information see page 80.

#### EUT monitoring

The system provides several alternatives for EUT monitoring applications:

- ◆ Via IEEE/IEC or RS-232-C interface
- ◆ Analog and digital I/O board (NI)
- ◆ Further alternatives on request



Contents Overview

Chapter Overview

Type Index

R&S Addresses





Contents Overview

Chapter Overview

Type Index

R&S Addresses



## Portable System for EMF Measurements R&S®TS-EMF



**Accurate measurements of electromagnetic fields caused by transmitter systems**

### Brief description

The Portable System R&S®TS-EMF measures electromagnetic fields in the environment. The measurements are necessary as a basis for discussions about the effects of electromagnetic radiation.



Owing to its wide frequency range from 30 MHz to 3 GHz, the system complies with all common radio services:

- ◆ Mobile radio (GSM, CDMA and UMTS)
- ◆ DECT
- ◆ *Bluetooth*®
- ◆ WLAN (802.11b)
- ◆ Sound broadcasting
- ◆ TV broadcasting

The frequency-selective measurements determine total emission but also permit assignment to specific radio services. Graphical and numeric result display with reference to a limit value simplifies evaluation.

### Main features

#### Versatile

- ◆ Wide frequency range from 30 MHz to 3 GHz
- ◆ Short-term and long-term measurements
- ◆ Editable measurement packets

#### Accurate

- ◆ High sensitivity and wide dynamic range

- ◆ Evaluation in compliance with radio services
- ◆ High measurement accuracy

#### Convenient

- ◆ Isotropic sensor
- ◆ Compact design
- ◆ Preconfigured

### Characteristics

The R&S®RFEX system software, which has been specially designed for measuring the effects of electromagnetic fields on the environment (EMCE), provides the user with predefined measurement packets for individual emitters. On site, only the required measurement packets and the measurement mode (single or long-term measurement) need to be selected. Equipped with an isotropic antenna, the measurement system is easy to operate and carries out measurements independently of direction and polarization.

### System design

The frequency-selective EMF measurement system consists of the following components:

- ◆ R&S®FSH3, a portable, robust and reliable spectrum analyzer
- ◆ An isotropic sensor for accurate field-strength measurements independent of signal direction and polarization
- ◆ R&S®RFEX, easy-to-operate system software that can be flexibly configured for versatile EMF measurements

### One system for various measurements

- ◆ Overview measurement
- ◆ Maximum field strength of an area (also in buildings)
- ◆ Measurement with averaging (referenced to limit values)
- ◆ Long-term measurement (minutes to days)
- ◆ Field-strength characteristic

The requirements of sites and measurement tasks can be met with great flexibility.

### Configurable

With the aid of the R&S®RFEX system software, the R&S®TS-EMF can be adapted to special tasks. All main



Contents Overview

Chapter Overview

Type Index

R&S Addresses







Contents Overview

Chapter Overview

Type Index

R&S Addresses



## Portable System for EMF Measurements R&S®TS-EMF

parameters, especially the measurement packets, limit values and measurement times, can be defined by the user so that additional radio services and country- and customer-specific requirements can be met.

### Accurate measurements

The predefined measurement packets of the R&S®RFEX system software for EMF measurements ensure optimum detection of individual radio services. Faulty measurements due to incorrect settings can thus be avoided particularly when pulsed signals are measured.

Owing to the high sensitivity and wide dynamic range of the system, even low field strengths can be accurately measured and emissions far below the ICNIRP limit can be detected. In addition, accurate measurements can be carried out at extended distances from the base station, the field-strength characteristic can be obtained and "before/after" comparisons (for renovations or expansions) can also be performed.

### Compact design

Due to the compact design of the R&S®TS-EMF, mobile and stationary measurements can be performed. The system can be accommodated in the R&S®F3H3 carrying bag (depending on laptop size).

### Specifications

Frequency range	30 MHz to 3 GHz isotropic reception due to orthogonally arranged antenna elements that can be electronically switched
Field-strength measurement range	approx. 1 mV/m to 100 V/m <sup>1</sup> )
Sensor connecting cable	2 m (detached sensor operation via long cables possible, see Recommended extras)
Sensor connectors	1 × N, 1 × 9-contact Sub-D (switch)
Tripod adapter	¼-inch thread (for standard tripod)
Power supply, mobile	internal NiMH battery, 4-hour operation; alternatively, external 15 V to 20 V DC
Power supply, AC	100 V to 240 V AC, 50 Hz to 60 Hz
Operating temperature range	0°C to + 50°C
Ambient conditions for sensor	–10°C to +50°C, safety class IP54
Weight	3.5 kg

Requirements for laptop/PC (not part of equipment supplied)	
Operating system	Windows2000, WindowsXP
Hard disk space	min. 4 Mbyte
Display resolution	min. 800 × 600
Interfaces	1 × USB 1 × RS-232-C (alternatively: 2 × USB with USB – RS-232-C converter)
Equipment supplied	– Spectrum Analyzer R&S®F3H3 – Isotropic sensor – EMF Software R&S®RFEX – Converter (for sensor control) – Cable set – Carrying bag for R&S®F3H3

<sup>1)</sup> In the case of high field strengths, controller and R&S®F3H3 must be operated in a shielded environment.

### Ordering information

Portable System for EMF Measurements	R&S®TS-EMF
<b>Recommended extras</b>	
1 set of sensor cables (8 m)	
Tripod	



Contents Overview

Chapter Overview

Type Index

R&S Addresses





Contents Overview

Chapter Overview

Type Index

R&S Addresses



## EMS Software R&S® EMS-K1

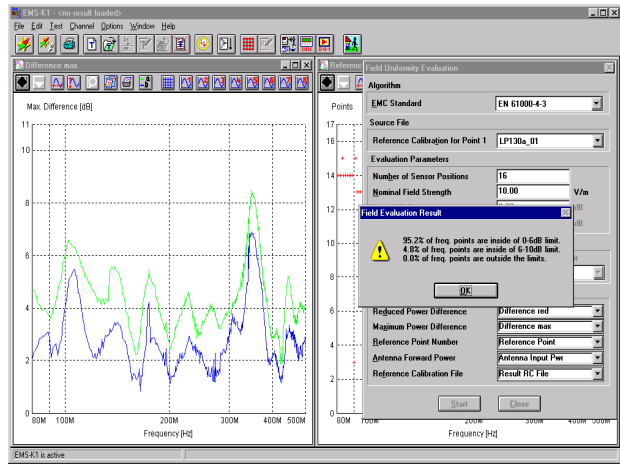
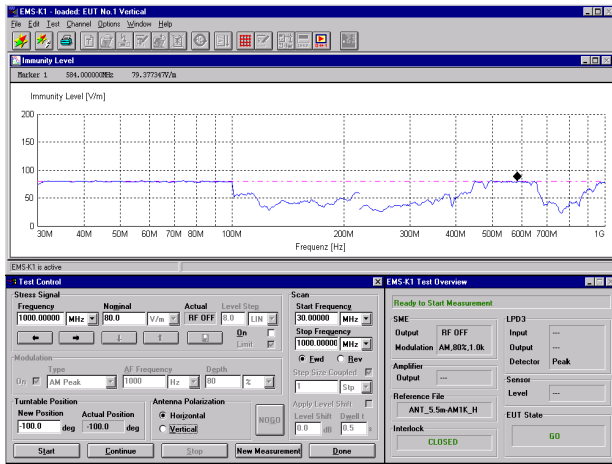

### Automatic measurement of electromagnetic susceptibility

#### Brief description

The powerful Software Package R&S® EMS-K1 forms the basis for the automatic control and monitoring of EMS test systems and also for the acquisition and analysis of the measurement data. The advantages of automation are:

- ◆ high reproducibility and accuracy of results
- ◆ automatic generation of detailed test reports
- ◆ permanent system control
- ◆ automatic calibration and correction of frequency-dependent parameters

The software is extremely user-friendly and has been optimized both for tests in development and acceptance tests. Pre-defined automatic test sequences and procedures as well as high flexibility for easy adaptation to new EMC standards and test methods are further outstanding features.

The basic functions of the R&S® EMS-K1 are:

- ◆ Automatic generation of test signals (field strength, current, voltage)
- ◆ Automatic monitoring of the EUT for malfunctions
- ◆ Determination of the immunity threshold at which an EUT malfunction occurs

The complete software package can be run on a PC or a PC-compatible industrial controller, e.g. Industrial Controller R&S® PSL (see page 376). The measurement devices are controlled via the IEC/IEEE bus using an integrated interface card.

#### Main features

- ◆ Automatic measurement of electromagnetic susceptibility in line with all commercial and military standards, e.g.
  - EN 61 000-4-3,-6
  - IEC 61000-4-3,6
  - ENV 50140/50141
  - ISO 11451/11452/10600

- VDE 0843
- DIN 40839
- VG 95373, part 10,13
- RTCA/DO-160C
- ◆ Running under Windows 9x/NT/2000/XP
- ◆ Open and modular system software concept
- ◆ High flexibility
- ◆ Programmable user interface
- ◆ Three types of user level:
  - normal
  - advanced
  - system manager
- ◆ Customer-specific test scripts
- ◆ Interface to other Windows programs
- ◆ Supports all EMS test systems from Rohde & Schwarz (R&S® TS 9981/82/83/86)

#### Automatic generation of immunity parameters

R&S® EMS-K1 is a universal EMS software package that can be used for just about any measurement method and test system:



Contents Overview

Chapter Overview

Type Index

R&S Addresses





Contents Overview

Chapter Overview

Type Index

R&S Addresses



## EMS Software R&S®EMS-K1

- ◆ measurement of immunity to radiated electromagnetic fields using an antenna, stripline, TEM or GTEM cell
- ◆ measurement of immunity to conducted interference using coupling/decoupling networks or current clamps
- ◆ measurement of immunity to magnetic fields

Three operating modes are available for setting the immunity level:

- ◆ Transducer: the immunity test level is set by means of a specified transducer correction factor (constant or frequency-dependent) for the amplifier or generator output power
- ◆ Reference calibration: based on calibration data from a reference measurement, the immunity test level is set using the frequency-dependent amplifier power values derived from the calibration measurement
- ◆ Sensor: the test level is set to the required value using the actual level measured with a sensor

### EUT monitoring

R&S®EMS-K1 provides logical monitor channels which can handle analog or digital data. A practically unlimited number of channels can be defined; the crucial limiting factor is processor power and the time required for monitoring. Depending on the graphics resolution, any number of channels can be displayed as on-screen diagrams during a measurement. The operator can change the selection of displayed channels while the measurement is running. If there is a NoGo condition, i.e. malfunction of the EUT, a variety of responses can be adopted:

- ◆ store the frequency and the EUT measurement value and continue the measurement automatically
- ◆ stop the program run to enter operator comments or
- ◆ branch to a user application routine, for instance to re-initialize the EUT

It is also possible to combine the above responses in a number of ways. A flexible control concept is implemented in the R&S®EMS-K1 by means of scripts.

### Measurement sequence control

The measurement sequence control in R&S®EMS-K1 software is encoded in scripts. The scripts are accessible to the user who can adapt them to his requirements. Scripts provide a high level of flexibility and are easy to modify.

The EMS measurement sequence is implemented by two standard scripts, the qualification mode and the susceptibility mode.

In the qualification mode the selected parameter profile (limits as a function of frequency) is run automatically and the responses of the EUT are recorded. If there is no malfunction detected, the EUT passes the test and fulfills the specified immunity limits. The measurement is thus completed. Only if there is a malfunction is the frequency in question noted automatically.

In the susceptibility mode the immunity threshold is automatically determined when a malfunction occurs. Level and frequency are recorded in the test report; the susceptibility profile of the EUT can then be displayed in the form of graphs or tables.

### Ordering information

Basic package		
System Software for EMS test systems R&S®TS9981 (EN 61000-4-3)	R&S®EMS-K14	1084.4296.02
Complete Software Package R&S®EMS-K14/15/16 with additional EUT Monitoring Drivers for EN 61000-4-3, -6	R&S®EMS-K9	1084.3948.02
Extensions		
Standard device driver package for R&S®EMS-K1 for EMS test systems 1 GHz to 18 GHz (e.g. R&S®TS9983), requires Basic Package R&S®EMS-K14	R&S®EMS-K8	1084.3890.00

EUT Monitoring		
Software extension for R&S®EMS-K1		
Basic device driver package for EUT monitoring	R&S®EMS-K20	1084.4196.00
Interface driver for EUT monitoring with external PC	R&S®EMS-K21	1084.4244.02
External EUT Monitoring Software R&S®EMON-K1, with interface driver for R&S®EMS-K1	R&S®EMS-K70	1084.6801.02



Contents Overview

Chapter Overview

Type Index

R&S Addresses





## CAN-Bus Monitoring R&S®EMON-K1

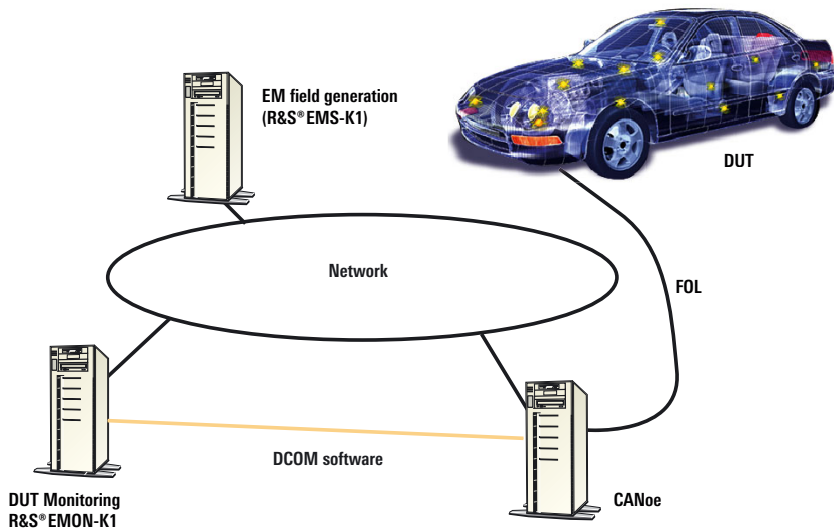

### CAN-bus monitoring when performing EMS measurements with R&S®EMS-K1

#### Main features

- ◆ Runs under WindowsNT4.0
- ◆ Starts and stops measurements in CANoe
- ◆ Measurements:
  - CAN-bus signals
  - Parameters for bus statistics
- ◆ Weights measurement results according to settable criteria, e.g. DUT malfunction yes/no
- ◆ Graphical and tabular display of measurements versus frequency of interfering EM field
- ◆ Sends measured field parameters (frequency, level, antenna polarization) to CANoe and signals DUT failures
- ◆ Starts user-specific actions on the CAN bus
- ◆ Powerful reporting tool
- ◆ Loading of databases in CANoe from R&S®EMON-K1 (as soon as supported by CANoe)

#### Software requirements

- ◆ CANoe, Vektor Informatik GmbH, as of version 3.0.40
- ◆ R&S®EMON-K1, version 2.0.0
- ◆ R&S®EMS-K1, version 1.20 with option R&S®EMS-K70

#### Miscellaneous

- ◆ Networked PC or controller operation recommended
- ◆ Software packages R&S®EMON-K1 and CANoe can be installed on the same PC or controller
- ◆ CAN-bus fiber-optic cable extender



## Contents of Chapter 9



*Highest quality and reliability: Industrial Controller R&S® PSL3*

Designation	Description	Type	Page
Portable Industrial Controller	Mobile measurements and control; Intel Pentium Mobile processor, 512 Mbyte RAM, 3½" drive Interfaces: IEEE 488.2, 2 × COM, 1 × LPT, PC CARD, 2 × Ethernet Graphics: variable from VGA to 1600 × 1200 pixels, 8.4" colour LCD	R&S®PSP7	374
Industrial Controller	Intel Pentium Mobile Processor, 512 MByte RAM, 3½" drive, DVD-Combo drive Interfaces: IEEE 488.2, 2 × COM, 1 × LPT, 2 × Ethernet	R&S®PSL3	376

Measurement software is described in connection with its specific applications in the individual chapters of the catalog.



Contents Overview

Chapter Overview

Type Index

R&amp;S Addresses



## Portable Industrial Controller R&amp;S®PSP7

### Mobile measurements and their control made to perfection



#### Brief description

At long last Portable Industrial Controller makes measurements and their control mobile. Thanks to its compact size and rechargeable batteries, the built-in test and measurement facilities of R&S®PSP can be used at any location and in any situation. The principle of "switch on and go" was consistently applied to the development of the R&S®PSP as with all of Rohde&Schwarz's previous process controllers. Everything one is likely to need is included as standard. Low emission and highly effective shielding are as much part of the R&S®PSP as shock and vibration resistance.

#### Operation

The front-panel keypad comprises a numeric block, programmable function keys and a cursor block with a spinwheel. The softkeys are fully integrated into Windows. The keypad includes as many keys as are needed to operate programs effectively under Windows, and few enough to avoid input errors. This is especially important for applications in the field of production. Whenever necessary, a keyboard and a monitor can be connected and run parallel to the front-panel keypad and the built-in display.

#### Fully independent powering

Through the DC input connector R&S®PSP can be powered by a solar panel. R&S®PSP also accepts DC voltages from cars, ships or aeroplanes. With the aid of cascadeable internal batteries the R&S®PSP can be kept in operation for several hours. The power management function informs the user on how long the R&S®PSP can operate with the remaining battery charge, and thus optimizes the available capacity and extends battery life.

#### Powerful hardware and software components

R&S®PSP comes with an IEC/IEEE bus fitted as standard. Software drivers for almost any programming language are included so that the time-consuming task of installing hardware and software becomes unnecessary. Moreover R&S®PSP with LabWindows/CVI comprises a highly specialized tool for software development.

#### LabWindows/CVI

National Instruments' LabWindows/CVI (C for Virtual Instrumentation) is an interactive base for the programming of virtual instruments on the R&S®PSP and is regarded by most as today's industry

standard. The software is delivered with a selection of drivers and extensive analysis functions. With LabWindows/CVI a C source code can be generated in next to no time, allowing communication with measuring instruments via IEC/IEEE bus or serial interface.

#### Interfaces

Numerous interfaces like 2 × serial, 1 × parallel, IEC/IEEE bus, PC card are the links to communication between the controller and the controlled devices.

#### Modular expansion

Despite its small size, R&S®PSP incorporates everything one needs for standard measurement tasks. And in the case that expansions should be necessary for unusual tasks, R&S®PSP can accommodate up to four additional long-size measuring cards.

#### Best of EMC characteristics

R&S®PSP was developed and implemented along existing EMC guidelines. Extensive filtering measures for the electric components paired with effective shielding and a novel design of the casing led to an industrial controller that can safely be employed even in the vicinity of highly sensitive receivers without impairing the measurement results.



Contents Overview

Chapter Overview

Type Index

R&amp;S Addresses



## Portable Industrial Controller R&S®PSP7

### Fit for the future

All of the components used in the R&S®PSP were developed and selected with long-term availability in mind so that the R&S®PSP will be able to be serviced or extended even in many years' time. An advantage that especially production engineers and system planners value.

*Interactive development and testing of measurement software is a prominent feature of LabWindows/CVI*

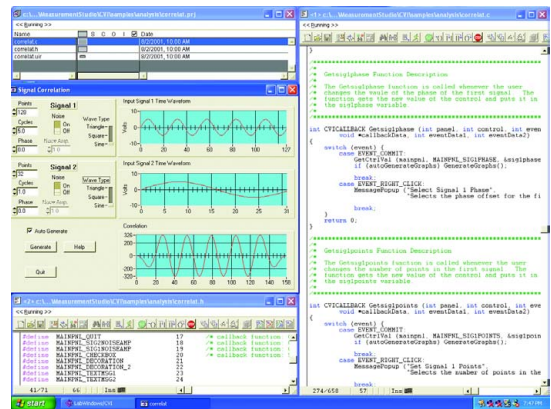

### Specifications in brief

You will find detailed and binding data on the enclosed CD (./DATASHEET/PSP7.pdf), or, for the latest updates, visit [www.rohde-schwarz.com](http://www.rohde-schwarz.com), search term: PSP7

<b>CPU</b>	Intel Pentium Mobile Processor
<b>RAM</b>	512 Mbyte
<b>Display</b>	LCD colour, 8.4"
<b>Screen</b>	anti-glare
<b>Mass storage</b>	
Hard disk drive	3 1/2"
Floppy disk drive	1.44 Mbyte, 3 1/2"
<b>Interfaces</b>	
<b>-internal-</b>	
Available interfaces	3 × 16 bits, dimensions (L × H):
ISA	330 mm × 140 mm
ISA	330 mm × 140 mm
ISA	312 mm × 140 mm
ISA/PCI	1 × 16 bit or 32 bit with L × H: 312 mm × 140 mm
<b>-external-</b>	
IEEE/IEC	IEEE488.2, compatible with NI NAT
Serial	2 × RS-232-C
Printer	Centronics LPT1 (ECP, EPP)
PCMCIA	release 2.0, type III, connector
Keyboard, mouse	5-contact DIN, 5-contact R&S®PS/2
USB	2 × USB 1.1
Ethernet	1 × 10/100 Mbit/s, RJ-45 1 × 10/100/1000 Mbit/s, RJ-45
<b>Software</b>	
Operating system	Windows XP Embedded (E) (optional)
Test & measurement software	LabWindows/CVI (optional)
<b>Graphics</b>	
With integrated LCD	VGA standard: 800 × 600 pixels
For external monitors	1600 × 1200 pixels max.
<b>General data</b>	
Rated temperature range	+5°C to +45°C
Power supply	
AC supply	100 V to 120 V ±10%, 50 Hz to 400 Hz ±5% 220 V to 240 V ±10%, 50 Hz to 60 Hz ±5%
DC supply	DC, 10 V to 32 V
Dimensions (W × H × D)	412 mm × 198 mm × 380 mm
Weight	8 kg

### Ordering information

<b>Portable Industrial Controller</b>	R&S®PSP7	1099.6002.74
<b>Accessories supplied</b>	pocket guide, manuals, power cable, connector for external DC operation	

### Options

<b>Software</b>		
(only together with R&S®PSP, factory fitted)		
Windows XP Embedded (E)	R&S®PSP-K12	1091.4700.32
Windows XP Embedded (E)	R&S®PSP-K13	1091.4800.32
+ LabWindows/CVI from NI		
<b>Interfaces</b>		
2nd IEC/IEEE Bus (AT GPIB, 488.2)	R&S®PS-B4	1006.6207.04
TTL I/O Interface, 40 I/O ports, 8 relays, 8 optocouplers, 3 timer	R&S®PS-B11	1006.7303.02
TTL I/O Interface without relays, optocouplers, timers	R&S®PS-B11	1006.7303.04
SCSI Host Adapter	R&S®PS-B27	1064.5500.02
SCSI PC Card Adapter	R&S®PS-B5	1134.8101.02
External USB CD-ROM Drive	R&S®PS-B6	1134.8207.02
<b>Memory</b>		
256 Mbyte Memory Card	R&S®CMU-Z1	1100.7490.04
PCMCIA Type III		
<b>Recommended extras</b>		
Compact keyboards with integrated trackball (37 cm × 13.8 cm × 1.9 cm)		
German	R&S®PSP-Z1	1091.4000.02
English	R&S®PSP-Z2	1091.4100.02
(other keyboards on request)		
IEC/IEEE bus Cable		
0.5 m	R&S®PCK	0292.2013.05
1 m	R&S®PCK	0292.2013.10
2 m	R&S®PCK	0292.2013.20
4 m	R&S®PCK	0292.2013.40



Contents Overview

Chapter Overview

Type Index

R&amp;S Addresses



## Industrial Controller R&amp;S®PSL3

**Powerful controller integrates  
easily in test environments**



## Brief description

**Maximum reliability**

Reliability, long service life and user-friendly service are of primary importance, particularly in industry. The R&S®PSL3 was optimized to meet exactly these requirements. Thus, we have good reason for using the R&S®PSL3 as the standard controller in our own Rohde & Schwarz system solutions.

**Excellent price/performance ratio**

Although industrial controllers tend to be expensive, the R&S®PSL3 is favourably priced. By focusing on the main functions, we were able to achieve an excellent price/performance ratio without compromising on the hardware components. The sophisticated concept offers maximum flexibility. Functionality can be expanded almost limitlessly.

**Tried-and-tested****Rohde & Schwarz quality**

Rohde & Schwarz is well-known for the high quality of its products and has years of expertise in the field of industrial controllers. Values specified in the data sheet such as mechanical resistance, temperature, safety and EMC characteristics are reliably checked and optimized through complex tests.

## Main features

- ◆ Maximum reliability due to fully optimized design and comprehensive tests in manufacture
- ◆ All development done inhouse and "made in Germany", ensuring availability for spare parts for years to come
- ◆ Excellent EMC values ensure minimum emission and block out electromagnetic interference
- ◆ Comprehensive interfaces for quick integration in test environments
- ◆ Energy-saving design throughout, thus low temperature stress on the components
- ◆ Customized and flexibly expandable
- ◆ Compact design, installable in racks
- ◆ Excellent price/performance ratio in the industrial segment

## Characteristics

**Device concept – compact and flexible**

Despite its small dimensions, the robust housing is extremely expandable. Cards can be inserted in four unused PCI slots and two ISA slots, thus protecting investments in existing systems that are based on the earlier bus system, and were in some cases expensive because they were customized. Clamps ensure the controller is locked firmly in place. The housing has

sufficient space to accommodate a second hard disk. A CD-RW/DVD disk drive is just as much part of the standard equipment as the 3.5" disk drive.

**Wealth of interfaces that leave almost nothing to be desired**

- ◆ Two USB controllers provide four USB ports, two of which are located at the front which is particularly advantageous in rack-mounting
- ◆ Two independent Ethernet controllers permit the flexible integration of the R&S®PSL3 in Ethernet networks (LAN). Here, too, one of the two interfaces is available at the controller front
- ◆ Two serial (COM1/COM2) and one parallel (LPT1 (ECP, EPP)) interface permit connections also to conventional test environments
- ◆ In addition to the analog VGA standard connection, the R&S®PSL3 also offers a digital DVI interface which allows operation of suitable TFT monitors without conversion losses (at different resolutions). The result is impressive – truly brilliant images
- ◆ Of course, an industrial controller would not be complete without a GPIB interface. It is included in the base unit and compatible with the quasi industrial standard set by National Instruments (AT-GPIB/TNT)



Contents Overview

Chapter Overview

Type Index

R&amp;S Addresses





## Industrial Controller R&S®PSL3

### Our commitment: excellent EMC values

The outstanding EMC values of the R&S®PSL3 block out all electromagnetic interference with the test setups. The controller was developed and designed thoroughly in accordance with EMC directives, with the core know-how of Rohde&Schwarz implemented in every aspect. Interfaces to the exterior are specially filtered, and keyboard (option R&S®PSL-Z2) and mouse (option R&S®PSL-Z10) have also been very carefully selected and tested in accordance with the latest EMC directives.



Rear view of the R&S®PSL3: View on the interfaces and free PCI and ISA slots

### Specifications in brief

You will find detailed and binding data on the enclosed CD (./DATASHEET/PSL3.pdf), or, for the latest updates, visit [www.rohde-schwarz.com](http://www.rohde-schwarz.com), search term: PSL3

<b>CPU</b>	Low Voltage Intel® Pentium Mobile Processor
<b>Memory</b>	L2 Cache, 512 kbyte SDRAM, 512 Mbyte
<b>Drives</b>	
Hard disk	3.5" 2nd HD with option R&S®PSL-B7
DVD-Combdrive CD	up to 700 MB, CD-R read/write 24x/24x or better CD-RW read/write 24x/10x or better
DVD	up to 8.5 Gbyte, DVD read 8x or better
Floppy disk	3 1/2", 1.44 MB
<b>Internal interfaces</b>	
Free slots	
PCI	4 x 32 bit, max 330 mm x 106 mm
ISA	2 x 16 bit, max 337 mm x 121 mm
<b>External interfaces</b>	
Display (max 1600 x 1200)	
DVI	DVI-D connector
VGA	15-pin sub-D connector
USB	4 x USB 1.1 with 2 USB controller
Ethernet	1 x 10/100 MBit/s, RJ45 1 x 10/100/1000 MBit/s, RJ45
Serial	2 x RS-232-C (COM), 9-pin sub-D connector
Parallel	Centronics LPT1 (ECP, EPP), 25-pin sub-D connector
IEC/IEEE	IEC 60625-2 (IEEE 488.2), compatible with NI TNT, 24-pin Amphenol connector

<b>Software</b>	
BIOS	AWARD
Operating System (optional)	Windows XP embedded (english)
Measurement software (optional)	LabWindows/CVI
<b>General data</b>	
Rated temperature range	+5°C to +45°C, meets EN60068-2-1 or -2
Power supply	Power factor correction meets EN61000-3-2 100 V to 240 V (AC) ±10%, 2.2 A to 0.15 A, 50 Hz to 60 Hz
Input	approx. 35 W
Power consumption (base unit)	
Dimensions (W x H x D)	465 mm x 150 mm x 517 mm (19"; 3 height units)
Weight (base unit)	approx. 9.5 kg

### Ordering information

Description	Type	Order number
Industrial Controller	R&S®PSL3	1161.5000.04
<b>Accessories supplied</b>	Pocket guide, driver (CD), power cable	
<b>Recommended extras</b>		
2nd Hard disk	R&S®PSL-B7	1157.6470.02
Keyboard, US character set, USB	R&S®PSL-Z2	1157.6870.03
Mouse, optical, USB	R&S®PSL-Z10	1157.7060.02
Operating System Windows XP embedded (english)	R&S®PSL-K12	1157.7160.02
Operating System Windows XP embedded (english) + Labwindows/CVI, full development version	R&S®PSL-K13	1157.7260.02
19"-Rack Adapter for R&S®PSL3	R&S®ZZA-311	1096.3277.00
IEC/IEEE Bus Cables		
0.5 m	R&S®PCK	0292.2013.05
1 m		0292.2013.10
2 m		0292.2013.20
4 m		0292.2013.40



*The R&S®NGPS32 is a programmable voltage source with two isolated identical outputs. It is suitable for use in automatic calibration and adjustment systems and as a reference voltage source in control processes*

## Contents of Chapter 10

Designation	Power rating	Type, Type series	Page
Range of Products, Introduction			379
Overview of Power Supplies			380
<b>Bench models</b>			
Single Power Supplies	28 W to 350 W	R&S®NGA 7.5 to 70; NGAS 32/10; NGB 32, 70; R&S®NGBI 35, 70; R&S®NGK 15 to 280, R&S®NGM 7.5 to 280	382
Dual and Triple Power Supplies	63 W to 72 W	R&S®NGL 35, NGMD 35, NGT 20, 25, 35	383
Precision Power Supplies	150 W	R&S®NGRU 35, 50, 100	385
<b>19" models</b>			
Power Supplies with high efficiency	1050 W	R&S®NGC 35, 70	385
Power Supplies with high output power	180 W to 2000 W	R&S®NGRE 6 to 100	388
<b>19" system models (IEC/IEEE bus)</b>			
Programmable Power Supplies	175 W/350 W	R&S®NGPU 70/10, NGPU 70/20	390
Programmable Power Supplies for use in labs and systems	80 W to 1400 W	R&S®NGPV 8 to 300, NGPX 35, 70, 150, NGPE 40, 35, 70	391
Programmable Power Supplies with arbitrary function	105 W	R&S®NGPS 32	399
Dual-Channel Analyzer/Power Supply	2 × 37.5 W	R&S®NGMO 2	400
Programmable Triple Power Supplies	105 W	R&S®NGPT 7, 18, 35	403
Programmable Power Supplies with arbitrary function	180 W	R&S®NGSM 32/10, R&S®NGSM 60/5	405



Contents Overview

Chapter Overview

Type Index

R&amp;S Addresses



## Range of Products, Introduction

The wide variety of Rohde&Schwarz power supplies falls into three main groups: bench models with output powers up to 350 W – eleven type series with a total of 29 basic models; 19" models with up to 2000 W output power – two type series with 29 basic models; system units/programmable power supplies with IEC625-1/IEEE 488 bus – five type series with 27 basic models.

### General technical features

All power supplies from Rohde&Schwarz are designed to offer essentially the same features: floating outputs, permissible voltage of the outputs with reference to chassis or ground – or with multiple output power supplies to one another – 1000 V.

### Setting of voltage and current

Settings start from a threshold near zero. The rated values specified for current and voltage are the maximally settable levels. Almost all types of the available power supplies are constant-voltage/constant-current units, which means that they can also be used as current regulators. Pilot lamps or LEDs indicate whether the unit is operating in the constant-voltage/constant-current mode or in the current limiting mode. All power supply units feature current limiting which can be continuously adjusted to any value between zero and the rated current. The current limiting of R&S®NGAS models can be set to 1.5 times the rated current.

### Parallel and series connection

If higher currents or voltages are required, all power supplies can be parallel- or series-connected. Protective circuits prevent the connected load or the power supply unit from being damaged.

The parallel connection capability is restricted for instruments with fast down programming (R&S®NGPV, R&S®NGPX, R&S®NGPE, R&S®NGMO2, R&S®NGSM).

### Output impedance $Z_{out}$

The output impedance is specified in the tables to describe the effect of load variations on the output quantity. For instance, with constant-current operation of a 100 V/1 A unit, a specified output impedance of  $Z_{out}=30\text{ k}\Omega$  means that a load variation between 0 and  $100\ \Omega$  at a nominal current of 1 A will cause a current deviation of 3 mA corresponding to 0.3%.

### Transient recovery time $t_r$

The value specified refers to a step change from 10% to 90% of the rated current in constant-voltage mode. After  $t_r$  the output voltage is again within tolerance. In constant-current mode  $t_r$  strongly depends on the load (<100  $\mu\text{s}$  to 1 s).

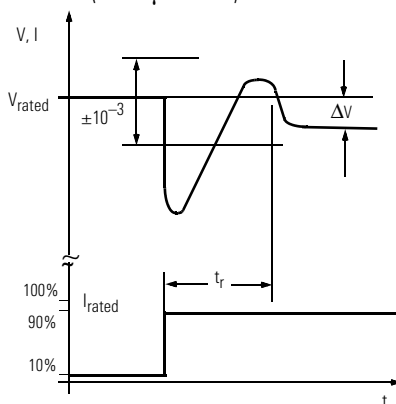

*Transient recovery time  $t_r$  following step change in load*

### Remote sensing

With models of >70 W output power, the voltage drop on the supply lead, which varies with the load current, can be corrected, if separate sensor leads are connected to the terminals of the load. A variation of 0.5 V to 1 V on the positive and negative leads can be compensated for.

### Remote control

R&S®NGRE power supplies can be equipped for analog remote control on request. R&S®NGRU models can be remote-controlled through external analog voltages as standard.

### Programming

Power Supplies R&S®NGPT/NGPV/NGPX/NGSM (with option)/NGPU/NGMO2 and R&S®NGPE are suitable both for manual operation and for control via IEC/IEEE bus, i.e. for use in automatic test systems.

### Cooling

The power supplies cannot be damaged by thermal overloading. The models of the R&S®NGM, NGK, NGMD, NGT, NGL and NGRU series have rear-mounted convective heatsinks. Models of higher output power rating use a two-stage (R&S®NGPT, NGSM, NGPX: continuously variable) thermostat-controlled cooling fan. At low demands the fan is running at low speed; only when high output is required it is switched to full power. The fans are driven by quiet, maintenance-free motors.

### Overload protection

To provide protection against undesirably high voltages caused by maloperation or faults, the power supplies are fitted with independent crowbar circuits with an adjustable response threshold (exceptions see table). An external overvoltage protection is also available:

Overvoltage Protection R&S®NG-Z, 4.5 V to 100 V/10 A, Order No. 0100.5103.02

### Output capacitor

The output capacitor can be switch-selected to match the load: small capacitance with little energy content for sensitive semiconductor circuits, large capacitance for dynamic loads.



Contents Overview

Chapter Overview

Type Index

R&amp;S Addresses





Contents Overview

Chapter Overview

Type Index

R&S Addresses



## Overview of Power Supplies

Type	Designation, Uses	Order No.	V <sub>max</sub> /V	I <sub>max</sub> /A	P <sub>max</sub> /VA	RS	OVP	RC <sub>DC</sub>	IEC	Page
R&S®NGM7.5	Universal constant-current and constant-voltage sources	117.7110.12	7.5	4	30	–	●	–	–	382
R&S®NGM15		117.7110.13	15	2	30	–	●	–	–	
R&S®NGM35		117.7110.14	35	1	35	–	●	–	–	
R&S®NGM70		117.7110.15	70	0.5	35	–	●	–	–	
R&S®NGM280		117.7110.06	280	0.1	28	–	–	–	–	
R&S®NGK15	Same as R&S®NGM, but double output current	192.0003.02	15	4	60	●	●	–	–	382
R&S®NGK35		192.0003.03	35	2	70	●	●	–	–	
R&S®NGK70		192.0003.04	70	1	70	●	●	–	–	
R&S®NGK280		192.0003.05	280	0.2	56	●	–	–	–	
R&S®NGA7.5	Constant-voltage sources with adjustable current limiting	192.0010.02	7.5	15	112	●	○	–	–	382
R&S®NGA15		192.0010.03	15	8	120	●	○	–	–	
R&S®NGA35		192.0010.04	35	4	120	●	○	–	–	
R&S®NGA70		192.0010.05	70	2	120	●	○	–	–	
R&S®NGAS32/10	Same as R&S®NGA, high surge capability	192.0803.04	16/32	10 (15)	160	●	○	–	–	382
R&S®NGB32	Constant-voltage sources with adjustable current timing	117.7210.90	32	10	320	●	●	–	–	382
R&S®NGB70		117.7227.90	70	5	350	●	●	–	–	
R&S®NGBI35		192.0910.31	35	10	350	●	●	–	–	
R&S®NGBI70		192.0910.31	70	5	350	●	●	–	–	
R&S®NGMD35	Dual power supply	117.7127.02	2 × 35	2 × 1	70	–	●	–	–	383
R&S®NGL35	Triple power supplies	192.0026.02	3 × 35	3 × 0.6	63	–	○	–	–	383
R&S®NGT20		117.7133.02	20/20/6	1/1/5	70	–	● (6 V)	–	–	
R&S®NGT25		192.0503.02	25/25/6	0.8/0.8/5	70	–	● (6 V)	–	–	
R&S®NGT35		191.2019.02	35/35/6	0.6/0.6/5	72	–	● (6 V)	–	–	
R&S®NGRU35	Precision power supplies	192.0210.03	35	10	150	●	●	●	–	385
R&S®NGRU50		192.0210.05	50	5	150	●	●	●	–	
R&S®NGRU100		192.0210.08	100	3	150	●	●	●	–	
R&S®NGC35	Universal high-power supplies	192.0032.02	35	30	1050	●	○	–	–	387
R&S®NGC70		192.0032.03	70	15	1050	●	○	–	–	
R&S®NGRE6 to 100		100.8xxx.xx	6 to 100	5 to 80	180 to 2000	●	○	○	–	388

RS = remote sensing  
OVP= overvoltage protection

RC<sub>DC</sub> = remote control with DC voltage  
\* = fast on/off switching via TTL-compatible signal

IEC = IEC625-2 bus (IEEE488)

● = standard  
○ = option



Contents Overview

Chapter Overview

Type Index

R&S Addresses





Contents Overview

Chapter Overview

Type Index

R&S Addresses



## Overview of Power Supplies

Type	Designation, Uses	Order No.	V <sub>max</sub> /V	I <sub>max</sub> /A	P <sub>max</sub> /VA	RS	OVP	RC <sub>DC</sub>	IEC	Page
R&S®NGPU70/10	Programmable power supplies	192.0049.92	70	10	175	●	●	–	●	390
R&S®NGPU70/20		192.0055.92	70	20	350	●	●	–	●	
R&S®NGPV8/10	Programmable power supplies	192.0310.8x	7.99	9.99	80	●	●	–	●	391
R&S®NGPV20/5		192.0310.2x	19.99	4.99	100	●	●	–	●	
R&S®NGPV20/10		192.0326.2x	19.99	9.99	200	●	●	–	●	
R&S®NGPV40/3		192.0310.4x	39.99	2.99	120	●	●	–	●	
R&S®NGPV40/5		192.0326.4x	39.99	4.99	200	●	●	–	●	
R&S®NGPV100/1		192.0310.1x	99.99	0.99	100	●	●	–	●	
R&S®NGPV100/2		192.0326.1x	99.99	1.99	200	●	●	–	●	
R&S®NGPV300/0.3		192.0310.3x	299.99	0.299	90	●	●	–	●	
R&S®NGPV300/0.6		192.0326.3x	299.99	0.599	180	●	●	–	●	
R&S®NGPX35/10		Programmable power supplies	192.0610.31	35	10	350	●	●	●*	
R&S®NGPX70/5	192.0610.71		70	5	350	●	●	●*	●	
R&S®NGPX150/2.3	192.0610.11		150	2.33	350	●	●	●*	●	
R&S®NGPE40/40	Programmable high-power supplies	192.0332.41	39.99	39.9	800	●	●	–	●	395
R&S®NGPE35/40		192.1116.31	35	40	1400	●	–	–	●	395
R&S®NGPE70/20		192.1116.71	70	20	1400	●	–	–	●	397
R&S®NGPS32	Programmable power supplies with arbitrary function	192.1016.31	±32	0.1	2 × 32	●	●	–	●	399
R&S®NGMO2	Dual-channel analyzer/ power supply	192.1500.24	2 × 15	2 × 7	2 × 37.5	●	●	●*	●	400
R&S®NGMO1	Single-channel analyzer/ power supply	192.1500.21	15	7	37.5	●	●	●*	●	400
R&S®NGPT7	Programmable triple power supplies	192.0510.71	7/7/18	5/5/2	105	●	●	–	●	403
R&S®NGPT18		192.0510.21	18/18/7	2/2/5	105	●	●	–	●	
R&S®NGPT35		192.0510.31	35/35/7	1/1/5	105	●	●	–	●	
R&S®NGSM32/10	Programmable power supplies with arbitrary function	192.0810.31	18/32	20/10	180	●	–	–	○	405
R&S®NGSM60/5		192.0810.61	32/60	10/5	180	●	–	–	○	

RS = remote sensing  
OVP = overvoltage protection

RC<sub>DC</sub> = remote control with DC voltage  
\* = fast on/off switching via TTL-compatible signal

IEC = IEC625-2 bus (IEEE488)

● = standard  
○ = option



Contents Overview

Chapter Overview

Type Index

R&S Addresses



## Single Power Supplies

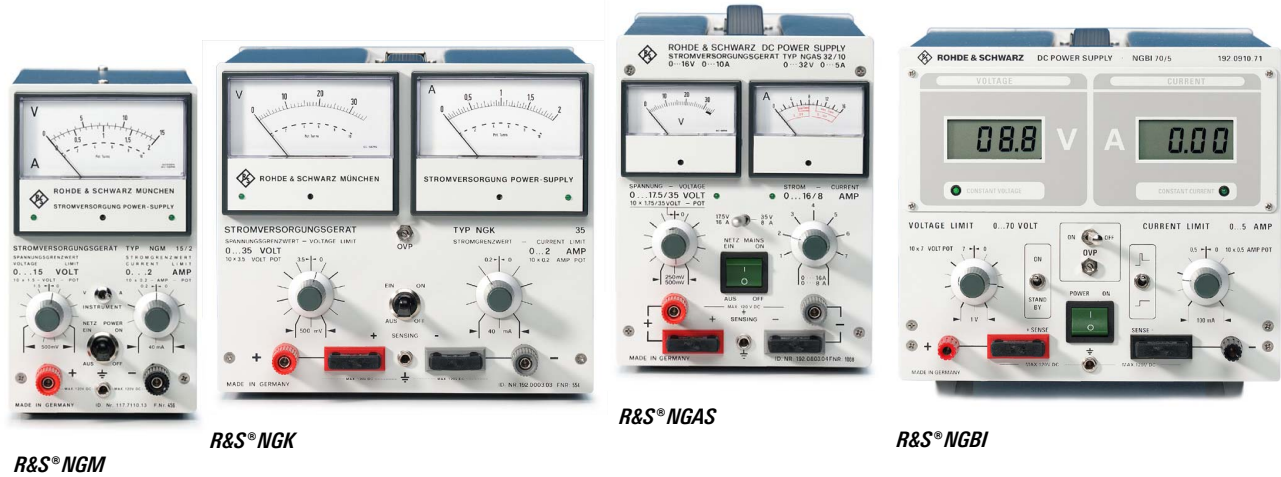

### R&S® NGM, R&S® NGK: 30/70 W lab models

- ◆ Compact bench models
- ◆ High-resolution ten-turn potentiometer for voltage and current
- ◆ Single switchable meter on R&S® NGM, separate meters on R&S® NGK

The power supplies of the R&S® NGM series can be used either as constant-voltage or as constant-current sources, e.g. in the laboratory. The power supplies of the R&S® NGK series provide twice the output current of the otherwise identical R&S® NGM models and are provided with remote-sensing sockets to compensate for voltage drops in the load leads.

### R&S® NGA: 120 W compact models

- ◆ High-resolution ten-turn potentiometer for voltage
- ◆ Separate meters, remote-sensing sockets

The power supplies of the R&S® NGA series are constant-voltage sources with adjustable current limiting. They are mainly used for the supply of modules and systems in testshops and labs.

### R&S® NGAS: 160 W compact model

- ◆ High surge capability, twice the rated current can be drawn for short periods
- ◆ Use as battery eliminators
- ◆ Separate meters for voltage and current

R&S® NGAS is suitable both for general lab applications and for the supply of loads with high surge or pulse-type current demands, e.g. test systems for car electronics or transceivers with switching power supplies.

Thanks to its compact design, R&S® NGAS is suitable for mobile use. It is insensitive to RF voltages radiated by other equipment or a nearby antenna.

The current limiting threshold can be set to 1.5 times the rated current which may be drawn for up to 5 minutes. Due to the delayed response of current limiting, twice the rated current may be drawn for several milliseconds. The output voltage range can be set to 16 V or 32 V.

### R&S® NGB, R&S® NGBI: 350 W bench models

- ◆ High-resolution ten-turn potentiometer for voltage and current
- ◆ Surge current capability – several times the rated current may be drawn for short periods

Suitable for use as constant-voltage/constant-current sources with automatic regulation of voltage-to-current transition (LED indication) and as battery eliminator with switch-selected delay for current regulation (higher surge current), e.g. for incandescent lamps, blinkers, voltage converters. Other features: large panel meters for voltage and current, voltage compensation on leads up to 1 V, adjustable overvoltage protection.

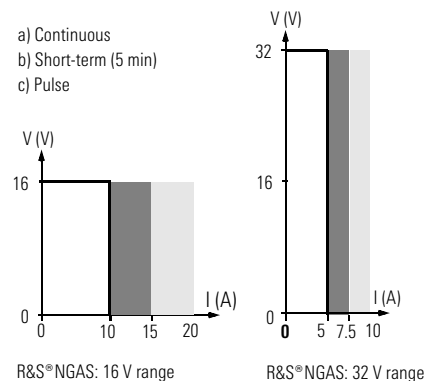

**Current drain of R&S® NGAS as a function of selected output voltage**



Contents Overview

Chapter Overview

Type Index

R&S Addresses



## Dual and Triple Power Supplies



R&S® NGMD35

### R&S® NGMD 35 – 2 × 0 to 35 V/1 A

- ◆ Independent or tracking operation
- ◆ Isolated floating outputs, permanently shortcircuit-proof

Two R&S® NGM35 power supplies are accommodated in one cabinet and can be used either separately or in tracking mode. In the tracking mode, unit II follows unit I. Relative to a common reference point, R&S® NGMD supplies a positive and a negative voltage of 0 to 35 V, which are concurrently and equally variable by a percentage of the voltage. The current limits can be set independently of each other.

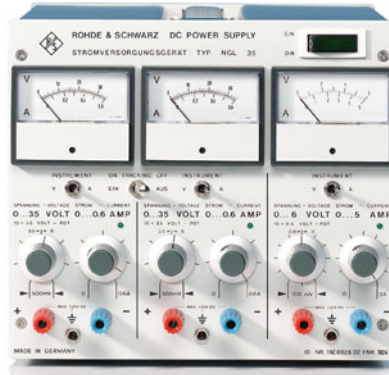

R&S® NGL35

### R&S® NGL 35 – 3 × 0 to 35 V/0.6 A

- ◆ Three voltages at a time, series or parallel connection
- ◆ Thermal overload protection, automatic power-up

R&S® NGL35 has three equal, separate and floating outputs. The voltages can be independently adjusted between 0 and 35 V and the current limiting threshold between 0 and 0.6 A. Voltage or current ratings can be tripled by parallel or series connection. A switchable panel meter is provided for each output.



R&S® NGT20

### R&S® NGT – 2 × 0 to 20/25/35 V 1/0.8/0.6 A; 1 × 0 to 6 V/5 A

- ◆ Independent or tracking operation of 20/25/35 V outputs
- ◆ Shortcircuit-proof, adjustable overvoltage protection (6 V output)

R&S® NGT models combine three independent voltage sources in one unit. A switchable panel meter is provided for each output. The 20 V, 25 V, 35 V outputs can be used separately, in series or parallel connection or in tracking mode. The independent 6 V output with its load rating of 5 A is especially designed for the supply of digital integrated circuits; overvoltage protection is adjustable.



Contents Overview

Chapter Overview

Type Index

R&S Addresses



## Single Power Supplies, Dual and Triple Power Supplies

### Specifications in brief of Single Power Supplies

Type	Order No.	Setting ranges		Resolution		Max. deviation of output for				Z <sub>out</sub> for		t <sub>r</sub> for			Max. PARD	Remote sensing Over-voltage protec.	Dimens. W × H × D (mm)	Weight (kg)
		Voltage V	Current A	V %	I %	ΔV AC supply ±10% V(%)	Δt <sub>amb</sub> -10 °C to +40 °C I(%)	V mΩ	I kΩ	V μs	V <sub>rms</sub> mV	I <sub>rms</sub> mA						
R&S®... NGA	7.5	192.0010.02	0.01 to 7.5	0.2 to 15	0.02	0.5	0.01	0.2	0.01	0.1	0.25	0.25	75	0.15	–	S	–	129/172/
	15	192.0010.03	0.01 to 15	0.1 to 8	0.02	0.5	0.01	0.2	0.01	0.1	0.375	1	75	0.3	–	S	–	330 (8)
	35	192.0010.04	0.01 to 35	0.05 to 4	0.02	0.5	0.01	0.2	0.01	0.1	0.875	4.4	75	0.6	–	S	–	
	70	192.0010.05	0.01 to 70	0.025 to 2	0.01	0.5	0.01	0.2	0.01	0.1	3.5	17.5	75	1	–	S	–	
NGAS	32/10	192.0803.04	0.01 to 32 0.01 to 16	0.1 to 10 (15)	0.02	0.5	0.01	0.2	0.01	0.1	0.16	1	75	0.6	–	S	–	129/172/ 330 (8)
NGB	32	117.7210.90	0.01 to 35	0.02 to 10	0.02	0.02	0.001	0.002	0.01	0.01	0.43	14	50	0.2	10	S	0	190/172/
	70	117.7227.90	0.01 to 70	0.01 to 5	0.02	0.02	0.001	0.002	0.01	0.01	1.75	56	50	0.5	5	S	0	330 (10)
NGBI	35	192.0910.31	0.01 to 35	0.02 to 10	0.02	0.02	0.001	0.001	0.01	0.01	0.438	14	50	0.2	1	S	0	190/172/
	70	192.0910.71	0.01 to 70	0.01 to 5	0.02	0.02	0.001	0.001	0.01	0.01	1.75	56	50	0.5	1	S	0	330 (10)
NGK	15	192.0003.02	0.01 to 15	0.01 to 4	0.02	0.02	0.001	0.002	0.01	0.01	0.75	37.5	50	0.2	0.1	S	0	190/172/
	35	192.0003.03	0.01 to 35	0.01 to 2	0.01	0.02	0.001	0.002	0.01	0.01	1.75	175	50	0.4	0.05	S	0	278 (8)
	70	192.0003.04	0.01 to 70	0.01 to 1	0.01	0.02	0.001	0.002	0.01	0.01	7	700	50	0.8	0.015	S	0	
	280	192.0003.05	0.01 to 280	0.002 to 0.2	0.01	0.02	0.001	0.002	0.01	0.01	140	700	50	3	0.005	S	–	
NGM	7.5	117.7110.12	0.01 to 7.5	0.01 to 4	0.02	0.02	0.001	0.002	0.01	0.01	0.75	10	50	0.2	0.1	–	0	95/172/
	15	117.7110.13	0.01 to 15	0.01 to 2	0.02	0.02	0.001	0.002	0.01	0.01	1.5	40	50	0.2	0.05	–	0	278 (4)
	35	117.7110.14	0.01 to 35	0.01 to 1	0.02	0.02	0.001	0.002	0.01	0.01	3.5	175	50	0.4	0.02	–	0	
	70	117.7110.15	0.01 to 70	0.01 to 0.5	0.01	0.02	0.001	0.002	0.01	0.01	14	700	50	0.8	0.001	–	0	
	280	117.7110.06	0.01 to 280	0.002 to 0.1	0.01	0.02	0.001	0.002	0.01	0.01	280	1400	50	3	0.002	–	–	

### Specifications in brief of Dual and Triple Power Supplies

Type	Order No.	Setting ranges		Resolution		Max. deviation of output for				Z <sub>out</sub> for		t <sub>r</sub> for			Max. PARD	Over-voltage protec.	Dimens. W × H × D (mm)	Weight (kg)
		Voltage V	Current A	V %	I %	ΔV AC supply ±10% V(%)	Δt <sub>amb</sub> -10 °C to +40 °C I(%)	V mΩ	I kΩ	V μs	V <sub>rms</sub> mV	I <sub>rms</sub> mA						
<b>Dual Power Supplies</b>																		
NGMD35	117.7127.02	0.01 to 35 (2 ×)	0.01 to 1	0.02	0.02	0.001	0.001	0.01	0.01	3.5	175	50	0.4	0.02	●		190/172/ 278 (8)	
<b>Triple Power Supplies</b>																		
NGL35	192.0026.02	0.01 to 35 (3 ×)	0.01 to 0.6	contin.	1	0.01	0.2	0.1	0.1	3.5	15	75	0.2	–	–		190/172/ 278 (7)	
NGT20	117.7133.02	0.01 to 20 (2 ×) 0.01 to 6 (1 ×)	0.01 to 1 0.01 to 5	0.02	1	0.01	0.2	0.01	0.1	2 1	9 0.4	75 75	0.15 0.2	–	●		190/172/ 278 (7)	
NGT25	192.0503.02	0.01 to 25 (2 ×) 0.01 to 6 (1 ×)	0.01 to 0.8 0.01 to 5	0.02	1	0.01	0.2	0.01	0.1	2.5 1	10 0.4	75 75	0.2 0.2	–	●		190/172/ 278 (7)	
NGT35	191.2019.02	0.01 to 35 (2 ×) 0.01 to 6 (1 ×)	0.01 to 0.6 0.01 to 5	0.02	1	0.01	0.2	0.01	0.1	3.3 1	15 0.4	75 75	0.25 0.2	–	●		190/172/ 278 (7)	



## Power Supplies R&amp;S®NGRU

**R&S® NGRU 35: 0 V to 35 V/0 A to 10 A**

**R&S® NGRU 50: 0 V to 50 V/0 A to 5 A**

**R&S® NGRU 100: 0 V to 100 V/0 A to 3 A**

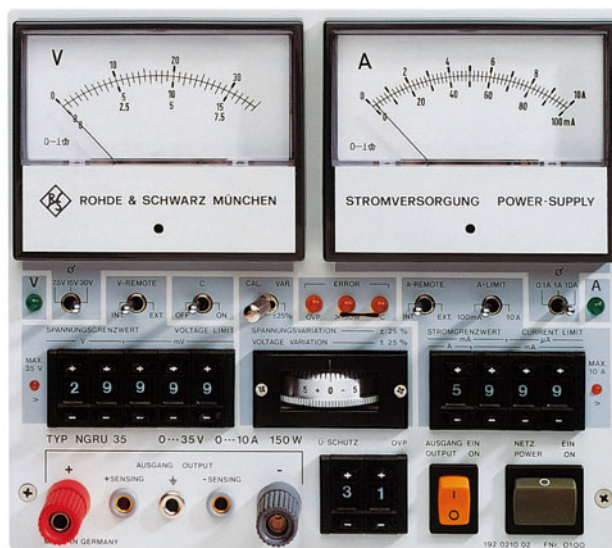

**R&S® NGRU 35**

## Brief description

Power Supplies of the R&S®NGRU series are precision laboratory units providing high accuracy and repeatability of voltage and current settings via digital potentiometers.

The power supplies can be used as constant-voltage or constant-current sources. The maximum output power is 150 W and remains constant over a wide voltage range. The current loadability depends on the output voltage.

## Main features

- ◆ Compact bench models
- ◆ High resolution and reproducibility through digital potentiometers
- ◆ Output voltage continuously variable with calibrated potentiometer
- ◆ Automatic power matching ensuring full power over wide output voltage range
- ◆ Digitally settable overvoltage protection
- ◆ Output voltage can be modulated – simulation of interference factors
- ◆ Remote programming of voltage and current
- ◆ Panel meter for voltage and current indication in three ranges
- ◆ Large LED indicators for overload, over-temperature, overvoltage protection and selected operating mode
- ◆ Switch-selectable output capacitor
- ◆ Remote sensing

## Operation

The voltage can be set in five digits and continuously varied by  $\pm 25\%$  with a calibrated potentiometer.

The current can be set in four digits within two ranges. The low range is 100 mA for all R&S®NGRU models so that even currents in the  $\mu\text{A}$  range can be reliably regulated.

The overvoltage protection is also set via digital potentiometer. In addition to manual operation, remote programming of voltage and current is possible by means of analog control signals.



Contents Overview

Chapter Overview

Type Index

R&S Addresses



## Power Supplies R&S®NGRU

### Specifications in brief

Voltage setting	R&S®NGRU 35	R&S®NGRU 50	R&S®NGRU 100
in 5 digits	<1 mV to 35 V	<1 mV to 50 V	<1 mV to 100 V
Resolution	1 mV	1 mV	1 mV
Max. error at 20°C	$\pm 10^{-4}$ of set value $\pm 20$ mV		
analog (continuously)	$\pm 25\%$ with $\pm 0.5\%$ setting error of scale		
Resolution	0.25%	0.25%	0.25%
<b>Current setting</b> (2 ranges in 4 digits)			
High range	<1 mA to 10 A	<1 mA to 5 A	>12 mA to 3 A
Resolution	1 mA	1 mA	1 mA
Max. error (20°C)	$\pm 2 \times 10^{-3}$ of set value $\pm 10$ mA		
Low range	<10 $\mu$ A to 100 mA		
Resolution	10 $\mu$ A	10 $\mu$ A	10 $\mu$ A
Max. error (20°C)	$\pm 2 \times 10^{-3}$ of set value $\pm 0.2$ mA		
Max. constant current (150 W)	up to 15 V: 10 A up to 20 V: 7.5 A up to 35 V: 4.3 A	up to 30 V: 5 A up to 40 V: 3.8 A up to 50 V: 3 A	up to 50 V: 3 A up to 75 V: 2 A up to 100 V: 1.5 A
<b>Constant-voltage source</b>			
Deviation of output voltage with			
$\pm 10\%$ AC supply	$< \pm 10^{-5}$		
0°C to 40°C	$< \pm 10^{-4}/K$		
10 to 90% load	$< 10^{-4}$		
PARD ( $V_{rms}$ )	<0.3 mV	<0.5 mV	<1 mV
Transient recovery time	<75 $\mu$ s		
<b>Constant-current source</b>			
Deviation of output current with			
$\pm 10\%$ AC supply	$< \pm 2 \times 10^{-5}$		
0°C to 40°C	$< \pm 2 \times 10^{-4}/K$		
10 to 90% load	$< 2 \times 10^{-4}$		
PARD			
high range ( $I_{rms}$ )	<2 mA	<1 mA	<0.3 mA
low range ( $I_{rms}$ )	<20 $\mu$ A	<20 $\mu$ A	<20 $\mu$ A
Sensing sockets			
Max. voltage compensation	<0.5 V	<1 V	<1.5 V

<b>Common data</b>	
Modulation of output voltage (BNC female, floating)	$V_{pp} = 10$ V for 10 V modulation, 50 Hz to 1 kHz $\pm 3$ dB
Input impedance	approx. 3.5 k $\Omega$
<b>Overvoltage protection</b>	
Setting range	1 V to 99 V (response threshold approx. 5% higher)
<b>Programming (external, analog)</b>	
for output voltage	
0% to 100%	0 V to 10 V
for output current 0% to 100%	0 V to 10 V
Setting time	<3 ms (to within $\pm 1\%$ )
Connector	5-contact Tuchel female
Input impedance	approx. 10 k $\Omega$
Reference potential	positive terminal
<b>General data</b>	
Meter accuracy	$\pm 2.5\%$ of full scale
AC supply	110/120/220/240 V $\pm 10\%$ , 47 to 63 Hz
Dimensions (W $\times$ H $\times$ D); weight	190 mm $\times$ 180 mm $\times$ 330 mm; 9 kg

### Ordering information

Power Supply	R&S®NGRU 35	0192.0210.03
	R&S®NGRU 50	0192.0210.05
	R&S®NGRU 100	0192.0210.08



Contents Overview

Chapter Overview

Type Index

R&S Addresses



## 1000 W Power Supplies R&S®NGC

**R&S® NGC35: 0 V to 35 V**

**0.05 A to 30 A**

**R&S® NGC70: 0 V to 70 V**

**0.025 A to 15 A**



R&S® NGC35

### Brief description

- ◆ Surge current capability – several times the rated current can be drawn for short periods
- ◆ High efficiency, 19" cabinet

The high efficiency of Power Supplies R&S®NGC is achieved through continuous preregulation. A series-pass regulator ensures for excellent static and dynamic characteristics. Special constructional measures allow use in RF systems.

### Specifications in brief

	R&S® NGC 35	R&S® NGC 70
Voltage	<10 mV to 35 V	<10 mV to 70 V
Current	<50 mA to 30 A	<25 mA to 15 A
Resolution	<0.02%	<0.02%
Deviation of voltage		
with ±10% AC supply variation	<±10 <sup>-5</sup>	
between 0 and 40°C	<±10 <sup>-4</sup> /K	
from 10% to 90% current	<10 <sup>-4</sup>	
Deviation of current		
with ±10% AC supply variation	<±10 <sup>-4</sup>	
between 0 and 40°C	<±10 <sup>-3</sup> /K	
from 10% to 90% voltage	<10 <sup>-3</sup>	
PARD		
Voltage V <sub>rms</sub>	<1 mV	<2 mV
Current I <sub>rms</sub>	<20 mA	<20 mA
Transient recovery time (10% to 90% load)	<60 μs	
Sensing sockets		
Surge current for 1 ms/0.2 s	80/60 A	40/30 A
Max. voltage compensation	0.5 V per lead	

General data	
Rated temperature range	0°C to +40°C
Meter accuracy	2.5% of full scale
AC supply	220 V ±10%, 50 Hz, 2.4 kVA (other values on request)
Dimensions (W × H × D)	484 mm × 194 mm × 509 mm
Weight	40 kg

### Ordering information

1000 W 19" Power Supply	R&S® NGC 35	0192.0032.02
	R&S® NGC 70	0192.0032.03



Contents Overview

Chapter Overview

Type Index

R&amp;S Addresses



## Power Supplies R&amp;S®NGRE

19" models – from about

200 W to 2000 W

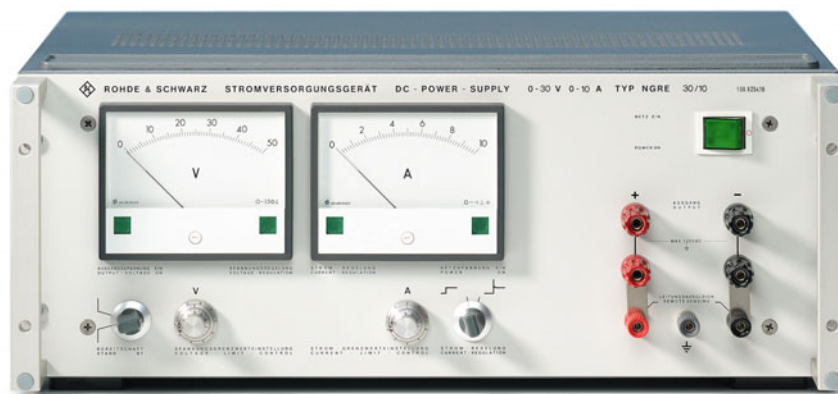
*R&S®NGRE in design A and B: cabinet model or rackmount, design B without operating controls*

## Brief description

Power Supplies R&S®NGRE provide high output power (from about 200 W). This type series is extremely versatile due to the use of standardized modules.

There are 27 basic versions (see table on next page), most of which come in five models. The basic versions only differ in the obtainable maximum voltage and current values and in the output impedance.

Each of these basic versions is equipped differently regarding meters, operating controls, connectors and is available as a cabinet model or rackmount.

Power Supplies of the R&S®NGRE series are designed for operation from 220 V AC supply. The power supplies can be adapted to other voltages upon request and at no extra cost.

## Main features

- ◆ Sustained shortcircuit-proof, thermal overload protection
- ◆ Series and parallel connection of several units possible
- ◆ Built-in overvoltage protection (optional)

## Operation

Voltage and current are set by means of high-resolution ten-turn potentiometers and indicated on separate panel meters. On request the power supplies are available with digital displays instead of analog panelmeters (ordering information R&S®NGRE MOD.DA). The power supplies are fitted with remote sensing sockets to compensate for voltage drops in the load leads. The two-stage cooling fan is thermostat-controlled and very quiet.

## Setting the current ranges

R&S®NGRE models .16 and .17 for currents up to 30 A are available on request with decade current ranges, e.g. a 10 A unit can be set to 0.1/1/10 A.

## Remote control

The following functions of models .12, .13, .16, .17 can be modified for remote control: output voltage, output current, power switch on/off/standby and control of power regulating element. Power supplies which have been modified for remote control may be operated in master-slave mode (optional). This mode, in which the output quantity is controlled by only one of the supplies involved, is especially recommended for equally splitting up the load current at high powers.

## Surge current capability

Two to three times the rated current may be drawn from the R&S®NGRE Power Supplies. An external or internal (model code number ...19) switch is provided for this purpose.

*R&S®NGRE MOD.DA fitted with digital displays*

Contents Overview

Chapter Overview

Type Index

R&amp;S Addresses



## Power Supplies R&S®NGRE

### Dimensions of different designs

Design	Cabinet model	Rackmount	Seated depth
<b>A</b>	484 mm × 194 mm × 436 mm	483 mm × 177 mm × 425 mm	347 mm
<b>B</b>	484 mm × 194 mm × 509 mm	483 mm × 177 mm × 498 mm	420 mm
<b>C</b>	608 mm × 394 mm × 284 mm	–	–

### Specifications in brief and order numbers

Setting ranges		Order number	Max. deviation of output for		Z <sub>out</sub> for		t <sub>r</sub> for	Max. PARD		Power consumption	Available design	Weight
Voltage V	Current A		ΔV AC supply ±10% V, I (%)	Δt <sub>amb</sub> –10°C to +40°C V, I (%)	V mΩ	(I) (kΩ)	V μs	V <sub>rms</sub> μV	I <sub>rms</sub> mA	at 220 V/50 Hz kVA		incl. case in kg
0 to 6	0 to 30	100.8402.xx	±0.001	0.01	1	(1)	<50	300	9	0.9	A, C	22
	0 to 40	100.8419.xx	±0.001	0.01	0.1	(1)	<50	300	12	0.9	A, C	22
	0 to 60	100.8425.xx	±0.001	0.01	0.1	(1)	<50	300	18	0.9	A, C	28
	0 to 80	100.8431.xx	±0.001	0.01	0.1	(1)	<50	300	24	1.8	B, C	29
0 to 10	0 to 20	100.8354.xx	±0.001	0.01	1	(2)	<50	300	6	0.9	A, C	19
	0 to 30	100.8360.xx	±0.001	0.01	1	(2)	<50	300	9	0.9	A, C	28
	0 to 40	100.8377.xx	±0.001	0.01	0.1	(2)	<50	300	12	1.8	A, C	28
	0 to 60	100.8383.xx	±0.001	0.01	0.1	(1)	<50	300	18	1.8	A, C	37
0 to 15	0 to 20	100.8319.xx	±0.001	0.01	1	(2)	<50	300	6	0.9	B, C	28
	0 to 30	100.8325.xx	±0.001	0.01	1	(2)	<50	300	9	1.8	A, C	28
	0 to 40	100.8331.xx	±0.001	0.01	0.1	(2)	<50	300	12	1.8	A, C	37
	0 to 60	100.8348.xx	±0.001	0.01	0.1	(1)	<50	300	18	2.5	B, C	39
0 to 30	0 to 10	100.8254.xx	±0.001	0.01	1	(5)	<50	300	3	0.9	A, C	19
	0 to 15	100.8260.xx	±0.001	0.01	1	(5)	<50	300	4.5	0.9	A, C	28
	0 to 20	100.8277.xx	±0.001	0.01	1	(3)	<50	300	6	1.8	A, C	28
	0 to 30	100.8283.xx	±0.001	0.01	1	(2)	<50	300	9	1.8	A, C	37
	0 to 40	100.8290.xx	±0.001	0.01	0.1	(2)	<50	300	12	2.5	B, C	39
	0 to 60	100.8460.xx	±0.001	0.01	0.1	(2)	<50	300	18	3.5	C	50
0 to 50	0 to 10	100.8219.xx	±0.001	0.01	1	(5)	<50	300	3	0.9	A, C	28
	0 to 15	100.8225.xx	±0.001	0.01	1	(5)	<50	300	4.5	1.4	A, C	28
	0 to 20	100.8231.xx	±0.001	0.01	1	(5)	<50	300	6	1.8	A, C	37
	0 to 30	100.8248.xx	±0.001	0.01	1	(3)	<50	300	9	2.5	B, C	39
	0 to 40	100.8454.xx	±0.001	0.01	0.1	(2)	<50	300	12	3.5	C	50
0 to 100	0 to 5	100.8160.xx	±0.001	0.01	1	(10)	<50	500	1.5	0.9	A, C	28
	0 to 10	100.8183.xx	±0.001	0.01	1	(10)	<50	500	3	1.8	A, C	37
	0 to 15	100.8190.xx	±0.001	0.01	1	(5)	<50	500	4.5	2.5	A, C	39
	0 to 20	100.8448.xx	±0.001	0.01	1	(5)	<50	500	6	3.5	C	50

### Completion of order numbers

Model code number (last two digits of Order No.)	Design	Voltage and current setting		Current range in three decades (up to 30 A) at extra cost	Four additional fixed voltages, push button-selected	Large meters for voltage and current
		Precision potentiometer on front panel	Screwdriver adjustment on rear panel			
13	19" cabinet		●			
17		●		●		●
12	19" rackmount		●			
16		●		●		●
19	Aluminium case	●			●	●

## Programmable Power Supplies R&S®NGPU

**R&S®NGPU 70/10: 175 W**

(70 V/max. 10 A)

**R&S®NGPU 70/20: 350 W**

(70 V/max. 20 A)

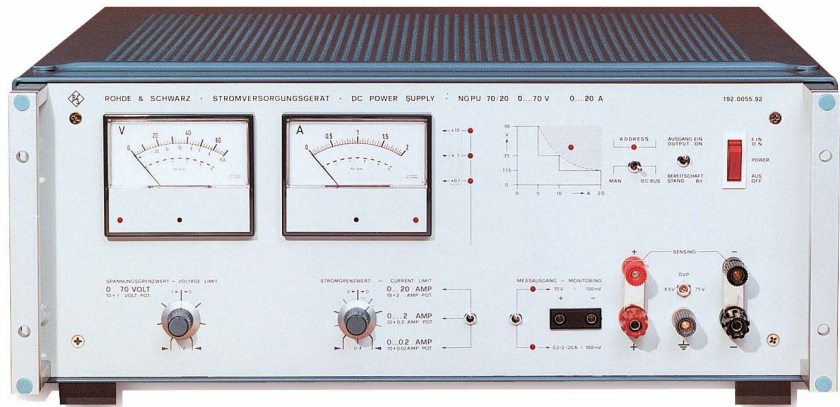

### Brief description

R&S®NGPU Power Supplies are constant voltage or constant-current sources, which can be programmed via IEC/IEEE bus or operated manually. Three selectable current ranges and one floating test output which can be switched between voltage and current make the R&S®NGPU ideal for use in IEC/IEEE bus test systems.

### Graduated current loadability

Since the current drain of many loads – for instance of transceivers – is inversely proportional to the supply voltage, a graduated current loadability is fully compatible with practical requirements. The maximum continuous current drain for the selected output voltage is indicated

on a scale of the panel voltmeter. Brief current surges exceeding this load limit are tolerable. If above 15 V a current exceeding this limit is permanently drawn, the power supply is disconnected from the AC supply via the built-in temperature monitor.

### Main features

- ◆ Programming via IEC/IEEE bus or manual operation
- ◆ Three-digit programming of voltage and current (1000 steps), resolution: 10 mV to 100 mV, 10 mA to 20 mA
- ◆ Output current in three decade ranges

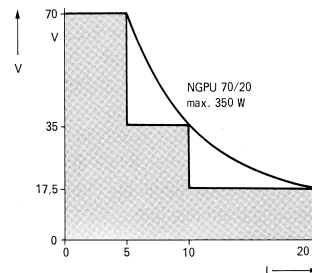
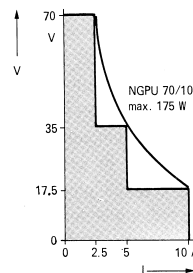

*Current loadability is graduated as a function of the output voltage. Full output current can be derived over almost 80% of the voltage range. As the figure shows, the characteristic practically combines the curves, i.e. the performance, of three individual supplies*

### Specifications in brief

	R&S®NGPU 70/10	R&S®NGPU 70/20
Voltage	<10 mV to 70 V	
Current (3 ranges)	0.1/1/10 A	0.2/2/20 A
Deviation of output voltage/current		
±10% AC supply variation	<10 <sup>-5</sup> / <sub>K</sub> + 5 × 10 <sup>-5</sup>	
between 0°C and 40°C	<(10 <sup>-4</sup> / <sub>K</sub> + 100 μV)/(10 <sup>-4</sup> / <sub>K</sub> + 100 μA)	
with 10% to 90% load	<10 <sup>-4</sup> / <sub>K</sub> + 5 × 10 <sup>-4</sup>	
PAR		
Voltage, V <sub>rms</sub>	<1.5 mV	<1.5 mV
Current, I <sub>rms</sub>	<5 mA	<10 mA
Transient recovery time		
(10% to 90% load)	<60 μs	<60 μs
Remote sensing	compens. for 0.5 V per lead	
Test output		
for voltage	100 mV ±1% at 70 V	
for current	100 mV ±2% for full scale	
Oversvoltage protection	adjustable from 4.5 V to 80 V	

General data		
Output quantities	adjustable via ten-turn potentiometer or IEC/IEEE bus	
Resolution manual control	0.02%	
Remote control	IEC 625-1 (IEEE 488)	
Resolution IEC/IEEE bus	1000 steps/range; for voltage adjustable 10 mV/step to 100 mV/step	
AC supply	110/220 V ±10%, 50 Hz to 60 Hz	
Power consumption	600 VA	1250 VA
Dimensions (W × H × D) in mm	492 × 161 × 514	492 × 205 × 514
Weight	14 kg	19 kg

### Ordering information

Programmable Power Supply	R&S®NGPU 70/10	0192.0049.92
	R&S®NGPU 70/20	0192.0055.92

## Programmable Power Supplies R&S®NGPV

**Power Supplies suitable for use in test systems and for general laboratory applications**



R&S®NGPV

### Brief description

Power Supplies of the R&S®NGPV series are suitable for use in test systems and for general laboratory applications.

#### Nine different models are available

R&S®NGPV 8/10	0 V to 8 V/0 A to 10 A
R&S®NGPV 20/5	0 V to 20 V/0 A to 5 A
R&S®NGPV 20/10	0 V to 20 V/0 A to 10 A
R&S®NGPV 40/3	0 V to 40 V/0 A to 3 A
R&S®NGPV 40/5	0 V to 40 V/0 A to 5 A
R&S®NGPV 100/1	0 V to 100 V/0 A to 1 A
R&S®NGPV 100/2	0 V to 100 V/0 A to 2 A
R&S®NGPV 300/0.3	0 V to 300 V/0 A to 0.3 A
R&S®NGPV 300/0.6	0 V to 300 V/0 A to 0.6 A

#### Each model comes in two versions

The version for use in systems and labs can be programmed via IEC/IEEE bus or operated manually. These power supplies are provided with the necessary operating controls, a digital LED display for indi-

cation of all input data including IEC/IEEE bus commands, and analog meters for indication of actual voltage and current values. The system version is without operating controls so that models for use in systems are lower-priced.

### Main features

- ◆ Digital setting, high resolution
- ◆ No discrete output capacitance, true current source
- ◆ Programmable via IEC/IEEE bus and manual control
- ◆ Short setting time for down programming thanks to current sinking
- ◆ Two current ranges – high-resolution current monitoring output
- ◆ Display of operating status and faults
- ◆ Thermostat-controlled cooling fan
- ◆ 19" design

### System use

Power Supplies R&S®NGPV are ideal for use in systems because of the short setting time of 2 ms which applies both to the rise time and thanks to controlled current sinking also to the fall time.

The R&S®NGPV models have no discrete output capacitance so that they can be used for regulating extremely low currents. Relay contacts will not be damaged by switching of current paths. A larger output capacitor can be switched into circuit manually or via the program.

### Remote sensing

Remote sensing is a particularly system-friendly mode since it is set automatically with no sensing links involved. In the sensing mode, the maximum output voltage of the power supply exceeds the specified nominal voltage only by the amount of the voltage drop in the leads. The load is thus fully protected, even in the presence of a shortcircuit, wrong polarity or interruption of the sensing leads.

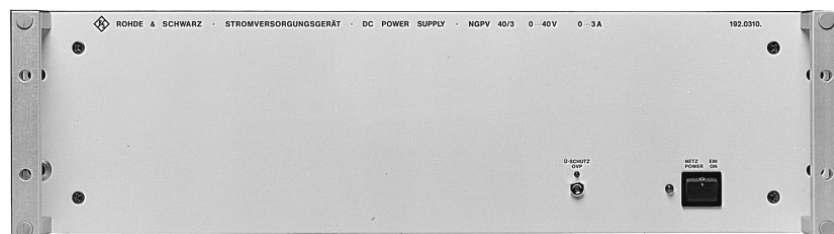

Power Supply R&S®NGPV for use in systems

## Programmable Power Supplies R&S®NGPV

### Specifications in brief

Type	NGPV 8/10	NGPV 20/5	NGPV 20/10	NGPV 40/3	NGPV 40/5	NGPV 100/1	NGPV 100/2	NGPV 300/0.3	NGPV 300/0.6
A1	0 V to 7.99 V	0 V to 19.99 V	0 V to 19.99 V	0 V to 39.99 V	0 V to 39.99 V	0 V to 99.9 V	0 V to 99.9 V	0 V to 299.9 V	0 V to 299.9 V
A2	10 mV/800	10 mV/2000	10 mV/2000	10 mV/4000	10 mV/4000	100 mV/1000	100 mV/1000	100 mV/300	100 mV/300
A3	<10 <sup>-5</sup>	<10 <sup>-5</sup>	<10 <sup>-5</sup>	<10 <sup>-5</sup>	<10 <sup>-5</sup>	<10 <sup>-5</sup>	<10 <sup>-5</sup>	<10 <sup>-5</sup>	<10 <sup>-5</sup>
B1	0 A to 9.99 A	0 A to 4.99 A	0 A to 9.99 A	0 A to 2.99 A	0 A to 4.99 A	0 A to 0.999 A	0 A to 1.99 A	0 A to 0.299 A	0 A to 0.599 A
B2	10 mA/1000	10 mA/500	10 mA/1000	10 mA/300	10 mA/500	1 mA/1000	10 mA/200	1 mA/300	1 mA/600
B3	<10 <sup>-5</sup>	<2 × 10 <sup>-5</sup>	<10 <sup>-5</sup>	<3 × 10 <sup>-5</sup>	<2 × 10 <sup>-5</sup>	<10 <sup>-5</sup>	<4 × 10 <sup>-5</sup>	<3 × 10 <sup>-5</sup>	<2 × 10 <sup>-5</sup>
B11	0 A to 999 mA	0 A to 999 mA	0 A to 999 mA	0 A to 999 mA	0 A to 999 mA	0 A to 99.9 mA	0 A to 99.9 mA	0 A to 99.9 mA	0 A to 99.9 mA
B12	1 mA	1 mA	1 mA	1 mA	1 mA	0.1 mA	0.1 mA	0.1 mA	0.1 mA
B13	<10 <sup>-5</sup>	<10 <sup>-5</sup>	<10 <sup>-5</sup>	<10 <sup>-5</sup>	<10 <sup>-5</sup>	<2 × 10 <sup>-5</sup>	<2 × 10 <sup>-5</sup>	<2 × 10 <sup>-5</sup>	<2 × 10 <sup>-5</sup>
C	<200 μV	<250 μV	<250 μV	<400 μV	<400 μV	<600 μV	<600 μV	<900 μV	<900 μV
D	500 pF/220 μF	500 pF/100 μF	750 pF/220 μF	500 pF/47 μF	750 pF/100 μF	500 pF/22 μF	750 pF/47 μF	500 pF/10 μF	750 pF/22 μF
E	4.5 V to 15 V	4.5 V to 25 V	4.5 V to 25 V	4.5 V to 50 V	4.5 V to 50 V	5 V to 110 V	5 V to 110 V	5 V to 330 V	5 V to 330 V

Output voltage	Output current (A range)	Output current (mA range)
A1: setting	B1: setting	B11: setting
A2: resolution (mV/steps)	B2: resolution (mA/steps)	B12: resolution (1000 steps)
A3: deviation (of fs)	B3: deviation (of fs)	B13: deviation (of fs)
C: PARD, V <sub>rms</sub>	D: output C (OFF/ON)	E: overvoltage protection (OVP)

### Common data

Constant-voltage source	
Deviation of output voltage	
with ±10% AC supply variation	<10 <sup>-5</sup>
between 0°C and 50°C	<2 × 10 <sup>-5</sup> /K
with 10% to 90% load	<10 <sup>-4</sup>
Transient recovery time (10% to 90%/90% to 10%)	<75 μs (to within ±10 <sup>-3</sup> )
Constant-current source	
Deviation of output current	
with ±10% AC supply variation	<10 <sup>-5</sup>
between 0°C and 50°C	<5 × 10 <sup>-5</sup> /K
with 10% to 90% load	<10 <sup>-4</sup>
Transient recovery time, output C OFF/ON	<50 μs/<2 ms
PARD, I <sub>rms</sub>	
in mA range	10 μA
in A range	100 μA/A

<b>Remote control</b>	IEC 625-1 (IEEE 488)	
Interface functions	SH0, AH1, TO, TE0, L1, LE0, SR0, RL1, PP1, DC1, DT1, CO	
Setting time (0% to 100%/100% to 0%)	<2 ms (to within ±2 × 10 <sup>-3</sup> )	
<b>Remote sensing</b>	compensation for 1 V per lead	
<b>Current monitoring output</b>		
mA range	100 mV ±1% for full scale	
A range	10 mV ±1%/A	
<b>General data</b>		
Meter accuracy	±2.5% of fs	
AC supply	110/120/220/240 V ±10%, 47 to 63 Hz	
Power consumption	approx. 250 VA	approx. 500 VA
Dimensions (W × H × D) in mm	492 × 161 × 392	492 × 161 × 420
Weight	12 kg	19 kg

### Ordering information

Type R&S®	NGPV 8/10	NGPV 20/5	NGPV 20/10	NGPV 40/3	NGPV 40/5	NGPV 100/1	NGPV 100/2	NGPV 300/0.3	NGPV 300/0.6
F1	192.0310.80	192.0310.20	192.0326.20	192.0310.40	192.0326.40	192.0310.10	192.0326.10	192.0310.30	192.0326.30
F2	192.0310.81	192.0310.21	192.0326.21	192.0310.41	192.0326.41	192.0310.11	192.0326.11	192.0310.31	192.0326.31

F1: system version

F2: system and lab version





Contents Overview

Chapter Overview

Type Index

R&S Addresses



## Programmable Power Supplies R&S® NGPX

**R&S® NGPX 35/10:**

**0 V to 35 V/0 A to 10 A**

**R&S® NGPX 70/5:**

**0 V to 70 V/0 A to 5 A**

**R&S® NGPX 150/2.3:**

**0 V to 150 V/0 A to 2.3 A**

**High-speed power supply for  
power pulse emulations**



R&S® NGPX35/10

### Brief description

Power Supplies R&S® NGPX are high-performance programmable laboratory units (350 W) using linear regulation. With their excellent regulation characteristics these 19" units are ideal for use in development labs. Thanks to convenient manual operation and IEC/IEEE bus control they can readily be integrated into production test systems. A rear trigger input allows fast on/off switching of the output voltage to support current-saving applications.

### Main features

- ◆ 350 W output power
- ◆ Low PARD thanks to linear regulation
- ◆ Accurate return signalling of voltage and current values, also via IEC/IEEE bus
- ◆ Effective current measurement with dynamic loads
- ◆ Fast up and down programming (typ. 10  $\mu$ s for R&S® NGPX35/10)
- ◆ Large alphanumeric LCD display for output of nominal and actual values as well as status information
- ◆ Nominal value input via numeric keypad; increment and decrement key
- ◆ Rear, isolated trigger input
- ◆ Rear isolating and polarity reversal relay (optional)
- ◆ Current monitor in 3rd current range with 25  $\mu$ A resolution (optional)
- ◆ Nonvolatile storage of 10 complete instrument setups
- ◆ Selectable foldback function
- ◆ Temperature-controlled cooling fan
- ◆ Soft limits for current and voltage
- ◆ Hardware overvoltage protection
- ◆ Remote sensing
- ◆ 19" system unit with IEEE488.2

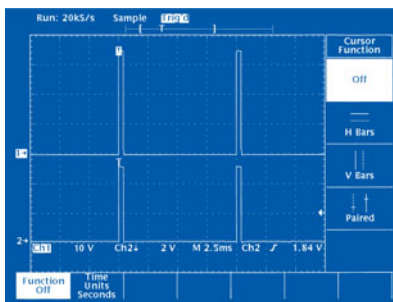

*DECT time slot simulation*  
CH1 = R&S® NGPX output  
CH2 = R&S® NGPX trigger input

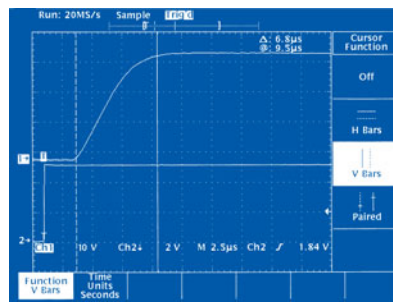

*Rise and fall times of only a few  $\mu$ s can be reached under all load conditions that comply with the R&S® NGPX specifications*

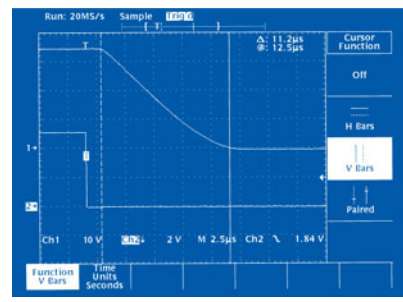

Contents Overview

Chapter Overview

Type Index

R&S Addresses





Contents Overview

Chapter Overview

Type Index

R&S Addresses



## Programmable Power Supplies R&S®NGPX

### Specifications in brief

Constant-voltage source	35/10	70/5	150/2.3
Voltage setting	0 V to 35.00 V	0 V to 70.00 V	0 V to 150.00 V
Resolution (mV/steps)	10/3500	20/3500	50/3000
Deviation from nominal value (±1 LSB)	<25 mV	<50 mV	<125 mV
±10% AC supply variation with load variation (10% to 90% of fs)	<±0.35 mV	<±0.7 mV	<±1.5 mV
Transient recovery time with load variation (10% to 90% of fs) to ±0.15%	<75 µs	<75 µs	<75 µs
Rise/fall time of output voltage (fast mode)	<10 µs typ.	<20 µs typ.	<20 µs typ.
PARD, $V_{rms}$ ( $C_{ON}/C_{OFF}$ )	<0.25/<0.5 mV	<0.5/<1.0 mV	<1/<2 mV
Voltage measurement	0 V to 40.95 V	0 V to 81.9 V	0 V to 204.75 V
Resolution (mV/steps)	10/4095	20/4095	50/4095
Deviation from measured value ±2 LSB)	<±35 mV	<±70 mV	<±150 mV
Constant-current source			
Current setting	0 A to 10.00 A	0 A to 5.00 A	0 A to 2.30 A
Resolution (mA/steps)	2.5/4000	1.25/4000	1/2300
Deviation from nominal value <sup>1)</sup>	<±10 mA ±1 LSB	<±10 mA ±1 LSB	<±5 mA ±1 LSB
±10% AC supply variation with load variation (10 to 90% of fs)	<±0.2 mA	<±0.2 mA	<±0.2 mA
PARD, $I_{rms}$ ( $C_{ON}/C_{OFF}$ )	<0.2/<0.6 mA	<0.1/<0.3 mA	<0.05/0.15 mA
Current measurement in range 1	0 A to 10.2375 A	0 A to 5.1188 A	0 A to 4.095 A
Resolution (mA/steps)	2.5 <sup>1)</sup> /4095	1.25 <sup>1)</sup> /4095	1/4095
Deviation from measured value ±2 LSB)	<±20 mA	<±10 mA	<±5 mA
Current measurement in range 2	0 A to 1.02375 A	0 to 511.88 mA	0 to 409.5 mA
Resolution (µA/steps)	250/4095	125 <sup>2)</sup> /4095	100/4095
Deviation from measured value ±2 LSB)	<±2 mA	<±1 mA	<±0.5 mA
Current measurement in range 3 (option)	0 A to 102.375 mA		
Resolution (µA/steps)	25 <sup>3)</sup> /4095	25 <sup>3)</sup> /4095	25 <sup>3)</sup> /4095
Deviation from measured value (±2 LSB)	<±30 µA <sup>3)</sup> <±2.5 µA/°C		
Overvoltage protection			
Operating range	4 V to 99.95 V	4 V to 99.95 V	4 V to 200 V
Resolution	50 mV	50 mV	100 mV
Response accuracy	±4 V	±4 V	±4 V

<sup>1)</sup> Readout rounded to full mA.

<sup>2)</sup> Readout rounded to full 100 µA.

<sup>3)</sup> Readout rounded to full 10 µA.

General data	
Refresh rate of display	3 updates per second
Refresh rate of measured value	update on each query
Setting time (incl. command processing)	typ. 4 ms (R&S®NGPX mode)
Outputs	floating, max. 250 V DC
AC supply	100/120/220/240 V; 47 Hz to 63 Hz
Power consumption	1400 VA
Dimensions (W × H × D)	492 mm × 161 mm × 513 mm
Weight	23 kg
Programming	IEC 625-2/IEEE 488.2

### Ordering information

Programmable Power Supply	R&S®NGPX35/10	0192.0610.31
	R&S®NGPX70/5	0192.0610.71
	R&S®NGPX150/2.3	0192.0610.11
Options		
Rear isolating and polarity reversal relay for	R&S®NGPX 35/10	0192.0610.32
	R&S®NGPX 70/5	0192.0610.72
	R&S®NGPX 150/2.3	0192.0610.12
Current monitor in current range 3 for	R&S®NGPX 35/10	0192.0610.33
	R&S®NGPX 70/5	0192.0610.73
	R&S®NGPX 150/2.3	0192.0610.13



Contents Overview

Chapter Overview

Type Index

R&S Addresses





Contents Overview

Chapter Overview

Type Index

R&S Addresses



## Programmable Power Supply R&S® NGPE 40/40

0 V to 40 V

0 V to max. 40 A



### Brief description

Programmable Power Supply R&S® NGPE is suitable for use in test systems and for general laboratory applications. The relatively small output capacitance, the short setting time even for down programming (thanks to built-in current sinking) as well as the voltage and current monitoring outputs are significant benefits in system use.

### Main features

- ◆ 0 V to 40 V/0 V to max. 40 A
- ◆ Primary-switched regulator with high efficiency and low heat dissipation
- ◆ Low PARD, excellent EMC, RFI suppression grade B
- ◆ Good regulation characteristics even with partial loading thanks to push-push converter configuration using power FETs

- ◆ Wide AC supply regulation range: 190 V to 265 V/95 V to 135 V
- ◆ Clear front-panel layout and LED display for voltage and current as well as IEC/IEEE bus commands
- ◆ Manual setting or via IEC/IEEE bus
- ◆ Separate panel meters for voltage and current, each with two switch-selected ranges
- ◆ High resolution and reproducibility due to decade setting
- ◆ High setting speed (for up programming independent of preset current limit, for down programming due to current sinking)
- ◆ Current monitoring output (two ranges)
- ◆ Voltage monitoring output
- ◆ Overvoltage protection (OVP)
- ◆ Thermostat-controlled cooling fan
- ◆ Remote sensing similar to R&S® NGPV
- ◆ 19" system unit

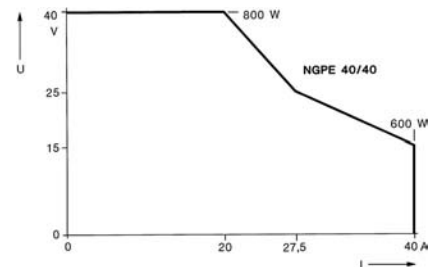

*The autoranging output characteristic shows that higher currents are available at lower voltages. At 15 V and 40 A the output power is still 600 W*



Contents Overview

Chapter Overview

Type Index

R&S Addresses





Contents Overview

Chapter Overview

Type Index

R&S Addresses



## Programmable Power Supply R&S®NGPE 40/40

### Specifications in brief

Voltage setting, in 4 digits	0 V to 39.99 V	
Resolution/Deviation	10 mV (4000 steps)/ $<10^{-3}$ of full scale	
Current setting, in 3 digits	0 A to 39.9 A	
Resolution/Deviation	100 mA (400 steps)/ $<2 \times 10^{-3}$ of full scale	
<b>Constant-voltage source</b>		
Deviation of output voltage		
with $\pm 10\%$ AC supply variation	$<10^{-4}$	
between 0°C and 45°C	$<2 \times 10^{-5}/^{\circ}\text{C}$	
with 10% to 90% nominal current	$<10^{-4}$	
Transient recovery time at 40 V		
from 2 A to 18 A or conversely	2.0 ms (to 150 mV)	
from 2 A to 4 A or conversely	0.2 ms (to 50 mV)	
from 16 A to 18 A or conversely	0.2 ms (to 50 mV)	
Setting time		
	without load	with load
from 0 V to 39 V	50 ms	60 ms
from 39 V to 0.4 V	100 ms	30 ms
from 39 V to 0.1 V	120 ms	40 ms
PARD, $V_{\text{rms}}/V_{\text{p}}$	2 mV/20 mV	
<b>Constant-current source</b>		
Deviation of output current		
with $\pm 10\%$ AC supply variation	$<10^{-4}$	
between 0°C and 45°C	$<10^{-4}/^{\circ}\text{C}$	
with 10% to 90% nominal current	$<10^{-4}$	

PARD, $I_{\text{rms}}$	$<40$ mA
Remote control	IEC 625-1 (IEEE 488)
Functions	SH0, AH1, T0, TE0, L1, LE0, SR0, RL1, PP1, DC1, DT1, C0
Remote sensing	compensation for 0.5 V per lead
<b>Panel meters</b>	
Voltmeter (2 ranges)	10/40 V $\pm 2.5\%$ of full scale
Ammeter (2 ranges)	4/40 A $\pm 2.5\%$ of full scale
<b>Monitoring output</b>	
for current	400 mV corresp. to 4 A, 2% of fs 400 mV corresp. to 40 A, 0.2% of fs
for voltage	0 V to 40 V, 0.2% of fs
<b>General data</b>	
Overvoltage protection (OVP)	4.5 V to 50 V
AC supply, selectable	95 V to 135 V or 190 V to 265 V, 47 Hz to 63 Hz, 1600 VA
Dimensions (W × H × D)	492 mm × 161 mm × 420 mm
Weight	14 kg

### Ordering information

<b>Programmable Power Supply</b>	R&S®NGPE 40/40	0192.0332.41
----------------------------------	----------------	--------------



Contents Overview

Chapter Overview

Type Index

R&S Addresses





Contents Overview

Chapter Overview

Type Index

R&amp;S Addresses



## Programmable DC Power Supplies R&S®NGPE35/40 and R&S®NGPE70/20

0 V to 35 V/0 A to 40 A

0 V to 70 V/0 A to 20 A

1400 W output power

IEEE 488 interface

**New**



*Programmable DC Power Supplies R&S®NGPE35/40*

### Brief description

R&S®NGPE35/40 and R&S®NGPE70/20 are programmable power supplies with max. 1400 W permanent output power. The requested values for voltage and power can be set either manually (with help of a 10 button keyboard) or through an IEEE488 interface. Also the measured values of voltage and current can not only be digitally read out on the front panel, but also through the IEEE488 interface.

The monitoring functions are e.g. alarms for low mains voltage, for failure of the power unit, for thermal overload and the case, that the output power is beyond the max. permitted value. The status of the regulator (voltage or current regulation) can also be obtained through the IEEE488 interface. Therefore, a sufficient integration in automatic test systems is possible.

Because of the technical concept as a switched-mode regulator, the R&S®NGPE35/40 and R&S®NGPE70/20 have a good efficiency (depending on the mains voltage between 85% and 90%). The active power factor correction enables a power factor between 0.99 to 0.98 at 100% to 50% output power. The use of remote-sensing connectors facilitates the compensation of voltage losses between power supply force connectors and D.U.T. of up to 1 V per load line.

The temperature controlled fan keeps the noise low, so that the R&S®NGPE35/40 and R&S®NGPE70/20 also pleasantly can be used in a lab.

### Main features

- ◆ High output power
- ◆ High efficiency
- ◆ Switched-mode regulator with active power factor correction
- ◆ Comfortably manual operation
- ◆ IEEE488 remote control
- ◆ Read out of current and voltage values
- ◆ Low noise fan (temperature controlled)
- ◆ Extensive monitoring functions



Contents Overview

Chapter Overview

Type Index

R&amp;S Addresses





Contents Overview

Chapter Overview

Type Index

R&S Addresses



## Programmable DC Power Supplies R&S®NGPE35/40 and R&S®NGPE70/20

### Specifications

Voltage	
Output voltage	
R&S®NGPE35/40	0 V to 35.00 V in 3500 steps
R&S®NGPE70/20	0 V to 70.00 V in 3500 steps
Setting resolution	
R&S®NGPE35/40	10 mV = 1 LSB
R&S®NGPE70/20	20 mV = 1 LSB
Deviation of the setted value	<2 LSB
Voltage measurement	
R&S®NGPE35/40	0 V to 35.00 V in 3500 steps
R&S®NGPE70/20	0 V to 70.00 V in 3500 steps
Measurement resolution	
R&S®NGPE35/40	10 mV
R&S®NGPE70/20	20 mV
Deviation of measured value	≤ ±4 LSB
Deviation at mains fluctuations from 95 V to 265 V (constant-voltage mode)	
R&S®NGPE35/40	<1 mV
R&S®NGPE70/20	<2 mV
Deviation at load variations 10% to 90%	
R&S®NGPE35/40	<5 mV
R&S®NGPE70/20	<10 mV
Ripple and noise (at 35 V, 39.9 A load and constant-voltage mode)	
R&S®NGPE35/40	<2 mV (RMS, bandwidth 0 to 1 MHz)
R&S®NGPE70/20	<10 mV (peak, bandwidth 0 to 50 MHz)
Ripple and noise (at 70 V, 19.9 A load and constant-voltage mode)	
R&S®NGPE35/40	<6 mV (RMS, bandwidth 0 to 1 MHz)
R&S®NGPE70/20	<25 mV (peak, bandwidth 0 to 50 MHz)
Load regulation time at load changes	
10% to 90% of the rated current	<10 ms
90% to 10% of the rated current	<10 ms
Setting time at voltage changes from 0 V to maximum	
R&S®NGPE35/40 (load current 36 A)	<13 ms
R&S®NGPE70/20 (load current 18 A)	<13 ms
R&S®NGPE35/40 (load current 4 A)	<8 ms
R&S®NGPE70/20 (load current 2 A)	<8 ms
Settling time at voltage changes from maximum to 0 V	
R&S®NGPE35/40 (load current 36 A)	<15 ms
R&S®NGPE70/20 (load current 18 A)	<15 ms
R&S®NGPE35/40 (load current 4 A)	<150 ms
R&S®NGPE70/20 (load current 2 A)	<150 ms

Current	
Output current	
R&S®NGPE35/40	0 A to 40 A in 4000 steps
R&S®NGPE70/20	0 A to 20 A in 4000 steps
Setting resolution	
R&S®NGPE35/40	10 mA = 1 LSB
R&S®NGPE70/20	5 mA = 1 LSB
Deviation of the setted value	<5 LSB
Current measurement	
R&S®NGPE35/40	0 A to 40.00 A in 4000 steps
R&S®NGPE70/20	0 A to 20.00 A in 4000 steps
Deviation of measured value	≤ ±4 LSB
Deviation at mains fluctuations from 95 V to 265 V at maximum load current (constant-current mode)	< 2 mA
Ripple and noise (at 1 V and maximum load current in constant current mode)	
R&S®NGPE35/40	<15 mA (RMS, bandwidth 0 to 50 MHz)
R&S®NGPE70/20	<10 mA (RMS, bandwidth 0 to 1 MHz)
	<15 mA (peak, bandwidth 0 to 50 MHz)
General data	
Efficiency at 1400 W output power and 230 V mains voltage	90%
Power factor	0.99 at 1400 W output power
Max. voltage compensation by help of sense lines	1 V per line
Isolation test voltage at output terminals	
vs. mains connectors	2500 V DC
vs. housing	500 V DC
mains connectors vs. housing	2500 V DC
Nominal temperature range	0°C to +40°C
Mains voltage range	95 V to 265 V
Space needed in a 19" system	1/1 (19") 3 HU
Dimensions (W × H × D)	442 mm × 131 mm × 442 mm
Weight	14 kg

### Ordering information

Programmable DC Power Supply	NGPE35/40	192.1116.31
	NGPE70/20	192.1116.71



Contents Overview

Chapter Overview

Type Index

R&S Addresses



## Programmable Voltage Source R&S®NGPS32

2 × −32 V to +32 V, max. 100 mA,

500 μV resolution



### Brief description

The R&S®NGPS32 is a programmable voltage source with two isolated identical outputs. The bipolar output voltages (−32 V to +32 V) can be set with high resolution either manually or via the IEEE 488 interface. Two integrated simple arbitrary generators allow independent output of low-frequency waveforms. The R&S®NGPS32 is suitable for use in automatic calibration and adjustment systems and as a reference voltage source in control processes.

### Main features

- ◆ 2 × −32 V to +32 V with 500 μV resolution
- ◆ Selectable current limit (100mA or 10mA)
- ◆ Two integrated simple arbitrary generators
- ◆ High thermal and long-term stability
- ◆ Floating output voltages, combinable as required
- ◆ Rear outputs with additional sensing connectors
- ◆ Ease of operation

In addition to static voltage values, low-frequency waveforms can be output. For this purpose, reference points (consisting of voltage value and time) can be entered manually or via IEC/IEEE bus. Between two neighbouring points, the arbitrary generator operates like a ramp generator, i.e. the programmed voltage difference is sampled as a ramp with the time T of the preceding point. The step size of the ramp is calculated automatically. The arbitrary generator can output the waveform only once or cyclically. The reference points are stored in a nonvolatile memory.

### Specifications in brief

<b>Outputs</b>	2 isolated, floating channels with rear outputs on terminal strip
Output voltage (per channel)	−32.7675 V to 32.7675 V in 131071 steps
Setting	via decimal keypad, rotary knob or IEEE488 bus
Setting resolution	500 μV
Deviation of full scale	±2 mV
Display	alphanumeric LCD display with 2 lines and 16 characters/line with adjustable LED lighting
Output current	selectable current limit, 10 mA or 100 mA, short-circuit-proof
Accuracy of current limit	±25%
Voltage deviation with AC supply variation of ±10%	±10 ppm
Voltage deviation with temperature variation from 0°C to +40°C	±10 ppm/°C
Instability	±1 ppm/h
Ripple and noise (20 Hz to 1 MHz)	<500 μV
Nonlinearity	<500 μV
Settling time	<700 μs over full output voltage range <100 μs for smallest programming step (500 μV)
Sensing voltage compensation	max. 250 mV per output line

<b>Arbitrary generator</b>	
Programming range	−32.7675 V to 32.7675 V in 500 μV steps
Max. number of reference points	200
Smallest time interval between 2 reference points	1 ms
Largest time interval between 2 reference points	32767 ms
Operating temperature range	0°C to +40°C
AC supply	100/120/220/240 V ±10%, 50 Hz to 60 Hz; 62.5 VA
Dimensions (W × H × D)	465 mm × 110 mm × 400 mm
Weight	6.75 kg

### Ordering information

<b>Dual Programmable Voltage Source (bipolar) with arbitrary function</b>	R&S®NGPS32	0192.1016.31
<b>Option</b>		
19" Rack Adapter 2 HU	R&S®ZZA-211	1096.3260.00



## Dual-Channel Analyzer/Power Supply R&amp;S®NGMO2

### Precise power supply and measurements under critical test conditions

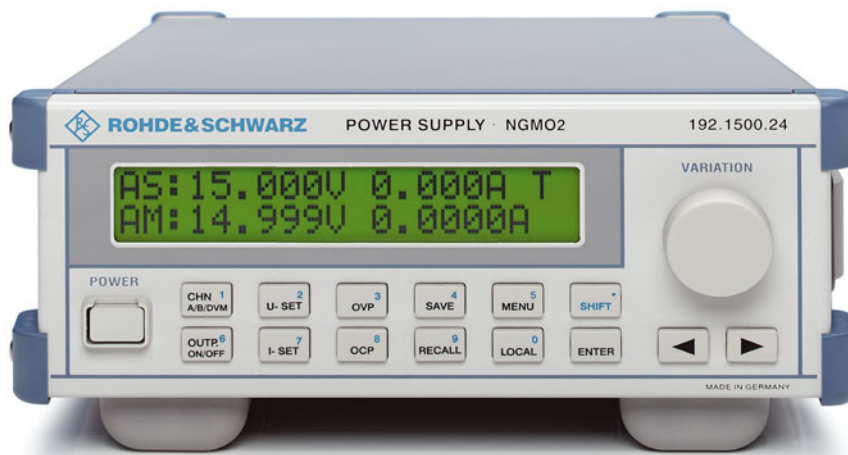

### Brief description

The Dual-Channel Analyzer/Power Supply R&S®NGMO2 is more than just a simple power supply for test and measurement applications. This is shown by its advanced features:

- ◆ Accurate high-speed voltage source
- ◆ Programmable DC load
- ◆ Precise digital voltmeter
- ◆ Transient recorder
- ◆ Simple squarewave generator delivering high output power

and two of each of these features are provided. Two independent channels, installed in an enclosure which is ½ 19" wide and only 2 HU, ensure a simple and accurate power supply for battery-operated mobile-radio products now and in the future.

### R&S®NGMO1

A single-channel solution of the R&S®NGMO2, containing only one of the both identical channels, is the R&S®NGMO1. The outside view and the channel specification is the same as from the R&S®NGMO2.

### Main features

- ◆ Two channels 15 V/2.5(5) A with 7 A peak
- ◆ Fast load regulation
- ◆ Result memory for fast current and voltage measurements
- ◆ Internal and external triggers
- ◆ Two separate voltage measurement channels
- ◆ Sinking to 2.8 A (static)
- ◆ High-resolution voltage settings
- ◆ Precise measurements in  $\mu$ A range
- ◆ Minimal ripple and noise
- ◆ Adjustable output impedance for battery emulation
- ◆ OVP/OCP
- ◆ Detection of open sense pins
- ◆ Auxiliary inputs/outputs (output inhibit, relay, complete, trigger)
- ◆ Compact design (2 HU, ½ 19")
- ◆ IEEE 488.2, RS-232-C
- ◆ Fast programming
- ◆ Convenient manual operation

### Further characteristics

#### Critical test environments involving pulsed current drain, e.g. GSM mobiles

Power-saving transmission technologies have been, and will continue to be, the key to expanding the capabilities of mobile radio. This is particularly true of transmission technologies that make use of time division multiplexing, for example GSM or TDMA, and also applies to the "slotted mode" used for CDMA – in both cases power supplies have to meet special requirements. R&S®NGMO2 can meet voltage drops without any hint of output voltage instability.

#### Emulation of various battery types and charging states

The R&S®NGMO2 can be used to emulate this critical case as its output impedance is adjustable. This also means that different types of batteries (NiCd, NiMH, Li-ion, Li-polymer etc) can be emulated to a certain extent. This ensures that nothing can happen to invalidate tests despite the general trend to lower supply voltages.





## Dual-Channel Analyzer/Power Supply R&amp;S®NGMO2

**Current-/voltage transient analysis**

Conclusions can be drawn about whether or not the subassemblies to be tested are functioning properly by forming the differences of the measured current drain of a sequence of signals occurring in rapid succession.

It goes without saying that long-term monitoring (current drain) can also be performed on DUTs by choosing sampling intervals of the appropriate length so that the effect of other operating parameters on current drain can be investigated. However, power consumption is also becoming more and more critical for subassemblies which are not battery-operated. Operating modes such as idle, sleep or power down are being encountered more frequently in electronic equipment because higher clock frequencies coupled with an increasing level of integration are making it impossible to ignore efficient energy management.

**Analysis software**

The R&S®NGMO2-K10 operating software for the R&S® Current Sniffer is a user-friendly tool for performing long-term analyses of energy consumption, short-term current/voltage analyses with high time resolution or simple battery tests on DUTs. The recorded trace files can be ported to other programs or analyzed again in a postprocessing run with high time resolution.

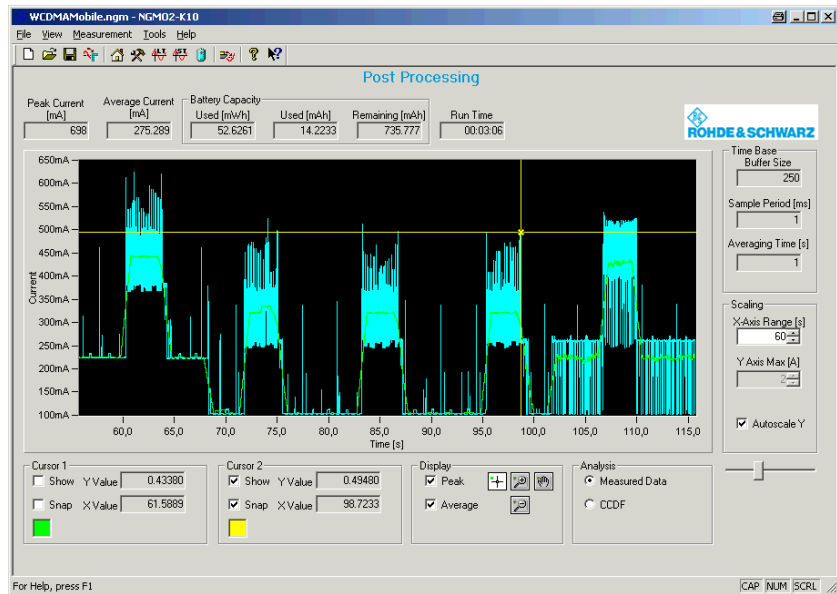

*"Fingerprint" of a WCDMA mobile phone in the long-term current analysis mode of the Current Sniffer R&S® NGMO2-K10 reveals possible energy guzzlers*

**High-resolution current measurements and voltage settings**

There are extremely wide variations in the current taken by mobile telephone operating modes. It is essential to have enough resolution to detect deviations from the normal mobile mode whenever they might occur. The R&S®NGMO2, therefore, has different current measurement ranges for both static and dynamic current measurements. The R&S®NGMO2 also has the necessary voltage setting resolution to calibrate and adjust DUTs and to provide reproducible voltage levels.

**Recording characteristics of semiconductor components**

The R&S®NGMO2 has two completely identical supply and measurement channels. This means that this small power supply unit can be used to form the basis of an independent parameter test setup for semiconductor components. The R&S®NGMO2 can also handle up to four relays and respond to remote control commands. As each channel has an inhibit input, if required, a pulsed supply voltage can be fed to the components to prevent overheating during tests or to simulate a standard pulsed operating mode (e.g. TDMA power amplifier).



Contents Overview

Chapter Overview

Type Index

R&S Addresses



## Dual-Channel Analyzer/Power Supply R&S®NGMO2

### Specifications

<b>Constant voltage source</b>	Channels 1 + 2 (both channels with identical specs)
Voltage setting	0 V to 15 V
Resolution	1 mV
Deviation	0.05% + 5 mV
at ±10% AC supply fluctuation	0.5 mV
at 10% to 90% nom. current	0.01% + 3 mV
Setting time on load steps (0.1 A to 1.6 A) at ≤20 mV	
Deviation at large bandwidth directly connected on "long" lines, with sense lead	<35 µs <50 µs
Deviation at small bandwidth directly connected on "long" lines, with sense lead	<80 µs <100 µs
Temporary voltage drop after load step (0.1 A to 1.6 A) at large bandwidth on "long" lines, with sense lead	<60 mV
Ripple (rms)	<1 mV
Output impedance	0 Ω to 1 Ω, adjustable in 10 mΩ steps
Voltage compensation	up to 1 V (4 V) per line
<b>Constant current source</b>	
Peak current (1 ms)	7 A
Current setting from 1.8 V to 5 V	0 A to 5 A
Current setting outside 1.8 V to 5 V	0 A to 2.5 A
Resolution	1 mA
Deviation	0.1% + 5 mA
at ±10% AC supply fluctuation	1 mA
at 10% to 90% nom. current	0.01% + 2 mA
Sinking	2.8 A (0 V to 5 V), dropping to 1 A at 15 V
<b>Voltage measurement</b>	
Range	-5 V to +25 V
Resolution	1 mV
Deviation	0.03% + 3 mV
Measurement rate	2 ms to 200 ms, adjustable
Averaging of	1 to 10 values
<b>Current measurement</b>	
Ranges	7 A/0.5 A/5 mA
Resolution	200 µA/10 µA/0.1 µA
Deviation	0.2% + (2 mA/100 µA/1 µA)
Measurement rate	2 ms to 200 ms, adjustable
Averaging of	1 to 10 values

<b>Transient measurement</b>	
Sample memory	1 to 5000 samples
Sampling interval (adjustable)	10 µs to 1 s in 10 µs steps
Averaging of	1 to 100 values
<b>Measurement system trigger</b>	
Current transients measurement ranges	5 A / 0.5 A
<b>Adjustable trigger thresholds</b>	
Range 5 A	0 mA to 5 A in 200 µA steps
Range 0.5 A	0 mA to 0.5 A in 10 µA steps
Voltage transients	-5 V to +25 V in 1 mV steps
Pre-/posttrigger	-5000 to +50000 samples
Measurement functions	Peak Min, Peak Max, Hi, Low, RMS, Average
<b>Protection functions</b>	
OVP	1.5 V to 22 V, adjustable
OCP	on/off
Detection of sense line interruptions	
<b>General data</b>	
Programming	IEEE 488.2, RS-232-C
Inputs	2 × measurement system trigger, 2 × output inhibit
Outputs	2 × complete, 4 × relay, fault
AC supply	115/230 V, 47 Hz to 63 Hz
Dimensions (W × H × D)	210.8 mm × 87.6 mm × 420 mm
Weight	
R&S®NGMO2	7.5 kg
R&S®NGMO1	5.02 kg

### Ordering information

<b>Dual-Channel Analyzer/Power Supply</b>	R&S®NGMO2	192.1500.24
<b>Recommended extras</b>		
Front-Panel Output Connectors	R&S®NGMO2-B0	192.1500.00
19" Adapter for 1 unit	R&S®NGMO2-B1	192.1500.01
19" Adapter for 2 units	R&S®NGMO2-B2	192.1500.02
Current Sniffer Software	R&S®NGMO2-K10	192.1500.04
<b>Single-Channel Analyzer/Power Supply</b>		
	R&S®NGMO1	192.1500.21



Contents Overview

Chapter Overview

Type Index

R&S Addresses





Contents Overview

Chapter Overview

Type Index

R&amp;S Addresses



## Triple Power Supply R&amp;S® NGPT

**R&S® NGPT35:****2 × 35 V/1 A and 1 × 7 V/5 A****R&S® NGPT18:****2 × 18 V/2 A and 1 × 7 V/5 A****R&S® NGPT7:****2 × 7 V/5 A and 1 × 18 V/2 A***Triple Power Supply R&S® NGPT35***Main features**

- ◆ Insensitive to RF voltages radiated by device under test or nearby antenna
- ◆ Very low PARD (periodic and random deviation) due to linear regulation
- ◆ 14 bit resolution
- ◆ Precise and stable over wide temperature range
- ◆ Simultaneous readout of nominal and actual values of all channels
- ◆ Output voltage of all channels simultaneously variable by a percentage value
- ◆ Nonvolatile storage of up to six complete setups
- ◆ Software calibration via IEC/IEEE bus without potentiometer adjustment
- ◆ Coupled protection mode for DUTs which should not be supplied from an asymmetrical voltage source

- ◆ Floating outputs, max. 120 V DC
- ◆ Remote sensing (0.5 V per lead)
- ◆ Soft limits for defined voltage and current limiting
- ◆ Hardware overvoltage protection
- ◆ Quiet, temperature-controlled fan
- ◆ 19" system unit, full system capability via IEC/IEEE bus interface (IEC625-1/IEEE488-2)

**Operation****Setting and display**

Three displays are provided for indication of the nominal and actual values. A separate display is provided for status information and menu-guided operation.

**Variable by percentage**

For module testing, R&S® NGPT35 provides the possibility of varying the output voltage of all three channels simultaneously in percent. After selection of the channels to be included in this operating mode, the desired variation can either be set via the numeric keypad or in steps of 0.1%, 1% or 10% using the increment/decrement keys.



Contents Overview

Chapter Overview

Type Index

R&amp;S Addresses





Contents Overview

Chapter Overview

Type Index

R&S Addresses



## Triple Power Supply R&S®NGPT

### Specifications in brief

Constant-voltage source	35 V	18 V	7 V
Voltage range	0 V to 35 V	0 V to 18 V	0 V to 7 V
Resolution	2.5 mV	2.0 mV	0.5 mV
Deviation of full scale	<0.01%	<0.01%	<0.01%
±10% AC supply variation			
0°C to 45°C	<0.001%	<0.001%	<0.001%
10% to 90% rated current	<0.005%/°C	<0.005%/°C	<0.005%/°C
Transient recovery time following load variation	0.01%	0.01%	0.01%
75 µs	75 µs	150 µs	
Programming time	35 ms	35 ms	35 ms
PARV (V <sub>rms</sub> )	200 µV	200 µV	100 µV
Constant-current source			
Current range	0 A to 1 A	0 A to 2 A	0 A to 5 A
Resolution	0.1 mA	0.2 mA	0.5 mA
Deviation of full scale	<0.02%	<0.02%	<0.02%
±10% AC supply variation			
0°C to 45°C	<0.002%	<0.002%	<0.002%
10% to 90% rated voltage	<0.01%/°C	<0.01%/°C	<0.01%/°C
Transient recovery time following load variation	0.02%	0.02%	0.02%
10 ms	10 ms	5 ms	
Programming time	60 ms	60 ms	60 ms
PARV (I <sub>rms</sub> )	20 µA	20 µA	100 µA
Display			
Voltage measurement	0 V to 40 V	0 V to 32.7660 V	0 V to 8 V
Resolution	2.5 mV	2.0 mV	0.5 mV
Deviation of full scale	<0.01%	<0.01%	<0.01%
0°C to 45°C	<0.005%/°C	<0.005%/°C	<0.005%/°C
Measurement rate	2 per s	2 per s	2 per s

	35 V	18 V	7 V
Current measurement	0 A to 1 A	0 A to 3,2766 A	0 A to 5 A
Resolution	0.1 mA	0.2 mA	0.5 mA
Deviation of full scale	0.02%	0.02%	0.02%
0°C to 45°C	<0.01%/°C	<0.01%/°C	<0.01%/°C
Measurement rate	2 per s	2 per s	2 per s
Soft limits			
Voltage range	0 V to 35 V	0 V to 18 V	0 V to 7 V
Resolution	2.5 mV	2.0 mV	0.5 mV
Current range	0 A to 1 A	0 A to 2 A	0 A to 5 A
Resolution	0.1 mA	0.2 mA	0.5 mA
Overvoltage protection			
Voltage range	1.5 V to 40 V	1.5 V to 25.55 V	1.5 V to 10 V
Resolution	100 mV	50 mV	20 mV
Deviation of full scale	<2%	<2%	<2%
Response time	50 µs	50 µs	50 µs
Voltage variation			
Resolution	0.1%	0.1%	0.1%
Range	0 V to 35 V	0 V to 18 V	0 V to 7 V
General data			
AC supply	100/120/220/40 V ±10%, 50 Hz to 60 Hz, 350 VA		
Dimensions (W × H × D)	492 mm × 161 mm × 514 mm		
Weight	16 kg		

### Ordering information

Triple Power Supply	R&S®NGPT35	0192.0510.31
	R&S®NGPT18	0192.0510.21
	R&S®NGPT7	0192.0510.71



Contents Overview

Chapter Overview

Type Index

R&S Addresses





Contents Overview

Chapter Overview

Type Index

R&S Addresses



## DC Power Supplies R&S®NGSM32/10, R&S®NGSM60/5

### R&S® NGSM32/10:

0 V to 18 V/10 A (20 A)

0 V to 32 V/5 A (10 A)

### R&S® NGSM60/5:

0 V to 32 V/5 A (10 A)

0 V to 60 V/2.5 A (5 A)

Designed for car electronics

applications in service,

laboratory and production

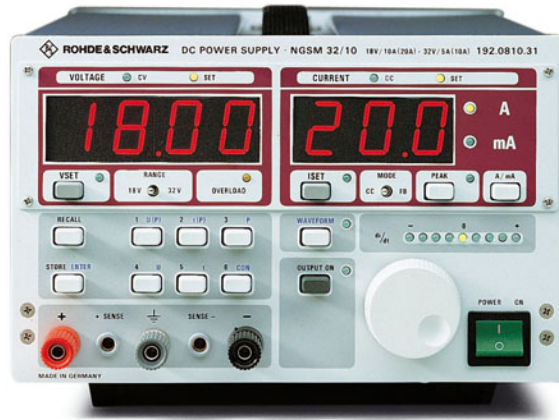

R&S® NGSM32/10

### Brief description

DC Power Supplies R&S®NGSM are versatile supply and measuring units for testing electronic car components by simulating real operating conditions. In addition to a wide field of car electronics, it can be used in mobile radio, car hifi applications and mechanical engineering. Due to its compact design, the units take up only one half 19" width. A 19" adapter is available for mounting the R&S®NGSM into test racks.

### Main features

- ◆ Excellent RF shielding and standby current measurement – ideal for mobile radio applications
- ◆ Trend indication for current measurements
- ◆ Car electronics testing by simulating motor startup
- ◆ Currents up to 20 A for car hifi applications
- ◆ Voltages up to 60 V for 42-V power-net in motor vehicles
- ◆ Storage of up to 12 device setups for short tests

- ◆ DUT protected against erroneous settings by ON/OFF output key
- ◆ IEC/IEEE bus or RS-232-C interface for use in production environments (optional)
- ◆ Acoustic signal upon changeover from voltage to current regulation – ideal for long-time testing
- ◆ Great ease of operation despite numerous functions

### Application-specific characteristics

#### Car electronics

R&S®NGSM is a precise and, thanks to its versatility, an extremely economical tool for use in the production of electronics. With the aid of an IEC/IEEE bus or

RS-232-C interface (optional), the power supply can readily be integrated into in-line production systems. The startup curve in line with DIN 40839 can be adapted to other factory standards by reprogramming it. High surge currents typically occur in applications such as central locking or ABS, but with a pulse current of up to 30 A, R&S®NGSM32/10 is ideally prepared for these applications.

#### Mobile radio systems

The high resolution for current measurements allows the maximum operating time of a mobile phone to be accurately predicted; typical voltage drops during the startup of a car – which have to be tolerated by telephones operated at a car net – can be simulated.

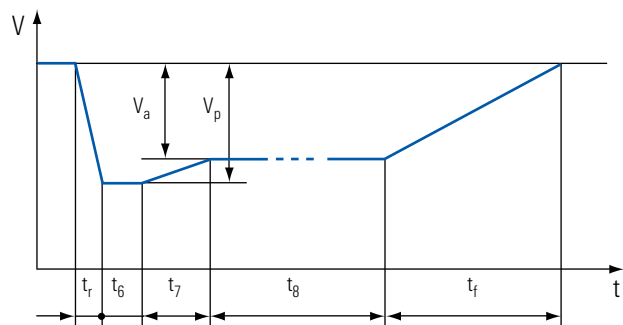

Startup curve to DIN 40839



Contents Overview

Chapter Overview

Type Index

R&S Addresses





Contents Overview

Chapter Overview

Type Index

R&S Addresses



## DC Power Supplies R&S®NGSM32/10, R&S®NGSM60/5

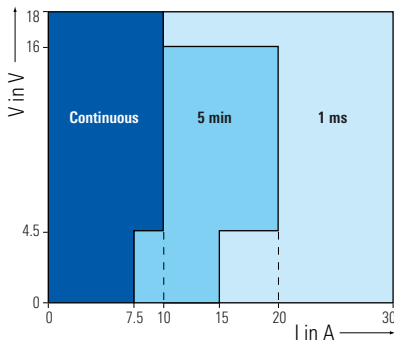

**R&S®NGSM32/10:**  
Current loadability in 18 V range

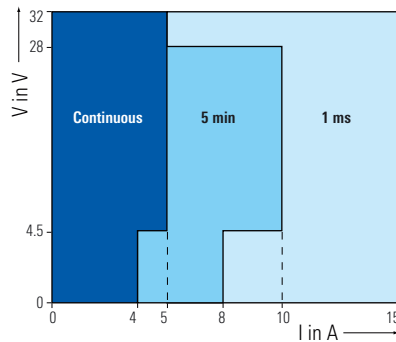

**R&S®NGSM32/10:**  
Current loadability in 32 V range

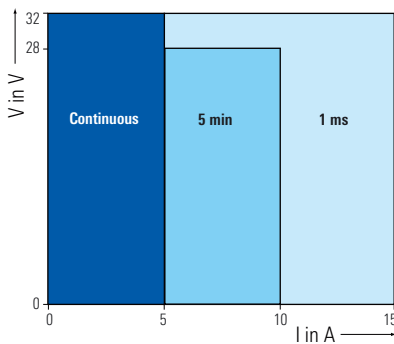

**R&S®NGSM60/5:**  
Current loadability in 32 V range

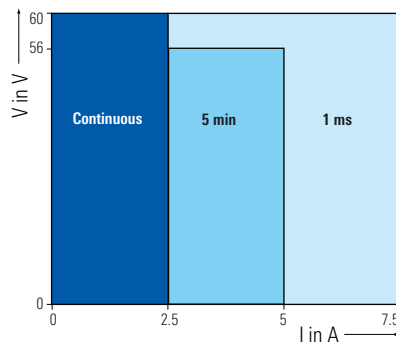

**R&S®NGSM60/5:**  
Current loadability in 60 V range

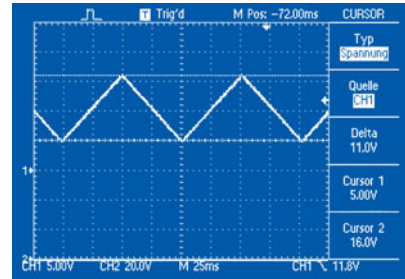

**Example of a triangle function, generated with the R&S NGSM**

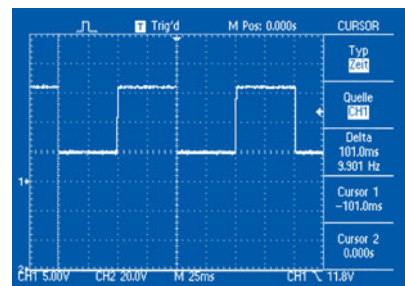

**Example of a rectangle function, generated with the R&S NGSM**

DC Power Supply R&S®NGSM is insensitive to the RF voltage conducted from a device under test or radiated from a nearby antenna.

### Car hifi

With a short-term load current of 20 A (R&S®NGSM32/10), even boosters can be supplied. Peak current measurements allow the power loading of devices to be predicted. Simulation of the startup curve to DIN40839 is also very useful in car hifi applications, e.g. to spot problems due to unexpected data loss of theft-proof car radios with security code.

### Simple arbitrary generator

R&S®NGSM can also be used as a simple arbitrary generator – but with the high output power of a power supply unit. Up to 60 reference values are available per voltage range which have to be programmed with lengths of stay of each 1 ms to 4 s. R&S®NGSM automatically interpolates between two values.

### Operation

DC Power Supply R&S®NGSM features a large-size, extremely easy-to-read display and simple operation despite its versatile functions. It always stores the last instrument setting used. Up to six settings as well as the data of the arbitrary generator can be stored for each voltage range and recalled whenever required. Any faults occurring during operation are immediately displayed and signalled by an acoustic alarm; for protection of the DUT in the event of a fault, the user can choose between the constant-current mode or automatic switch-off. The sensing lines are provided with an integrated protection against wrong polarity for added safety.



Contents Overview

Chapter Overview

Type Index

R&S Addresses



## DC Power Supplies R&S®NGSM32/10, R&S®NGSM60/5

### Specifications in brief

Constant-voltage source	R&S®NGSM32/10		R&S®NGSM60/5	
Voltage setting	0 V to 18 V	0 V to 32 V	0 V to 32 V	0 V to 60 V
Resolution	10 mV	10 mV	20 mV	20 mV
Deviation of full scale	<0.4%	<0.2%	<0.2%	<0.2%
with ±10% AC supply variation	<0.01%	<0.01%	<0.01%	<0.01%
between 0 and 45°C	<0.02%/°C	<0.02%/°C	<0.02%/°C	<0.02%/°C
with 10% to 90% nom. current	0.01%	0.01%	0.01%	0.01%
Transient recovery time after load variation	0.1 ms	0.1 ms	0.1 ms	0.1 ms
PAR, V <sub>rms</sub>	1 mV	1 mV	2 mV	2 mV
Constant-current source	R&S®NGSM32/10		R&S®NGSM60/5	
Current setting	0 A to 20 A	0 A to 10 A	0 A to 10 A	0 A to 10 A
Resolution 0 A to 9.99 A	10 mA	10 mA	10 mA	10 mA
Resolution 10 A to 20 A	100 mA	100 mA	100 mA	100 mA
Deviation of full scale	<0.5%	<1.5%	<1.5%	<1.5%
with ±10% AC supply variation	<0.02%	<0.02%	<0.02%	<0.02%
between 0°C and 45°C	<0.05%/°C	<0.05%/°C	<0.05%/°C	<0.05%/°C
with 10% to 90% nom. voltage	0.2%	0.2%	0.2%	0.2%
PAR, I <sub>rms</sub>	20 mA	20 mA	20 mA	20 mA
Current loadability				
Continuous current	0 A to 10 A*	0 A to 5 A	0 A to 5 A	0 A to 2.5 A
Surge current (max. 5 min)	0 A to 20 A*	0 A to 10 A	0 A to 10 A	0 A to 5 A
Impulse current (max. 1 ms)	0 A to 30 A*	0 A to 20 A	0 A to 15 A	0 A to 7.5 A
*reduced output currents at V ≤ 4.5 V				
Display	R&S®NGSM32/10		R&S®NGSM60/5	
Voltage measurement	0 V to 40 V	0 V to 40 V	0 V to 80 V	0 V to 80 V
Resolution	10 mV	10 mV	20 mV	20 mV
Deviation of full scale	<0.2%	<0.1%	<0.1%	<0.2%
between 0°C and 45°C	<0.02%/°C	<0.02%/°C	<0.02%/°C	<0.02%/°C
Measurement rate	6/s	6/s	6/s	6/s
Current measurement in mA range	0 mA to 199 mA	0 mA to 199 mA	0 mA to 199 mA	0 mA to 199 mA
Resolution 0 mA to 99.9 mA	0.1 mA	0.1 mA	0.1 mA	0.1 mA
Resolution 100 mA to 199 mA	1 mA	1 mA	1 mA	1 mA
Current measurement in A range	0 A to 40 A	0 A to 40 A	0 A to 40 A	0 A to 40 A
Resolution 0 A to 9.99 A	10 mA	10 mA	10 mA	10 mA
Resolution 10 A to 40 A	100 mA	100 mA	100 mA	100 mA
Deviation of current measurement (mA, A)	<0.5% ±1 LS of rdg	<0.5% ±1 LS of rdg	<0.5% ±1 LS of rdg	<0.5% ±1 LS of rdg
between 0°C and 45°C	<0.1%/°C	<0.1%/°C	<0.1%/°C	<0.1%/°C
Peak current measurement	0 A to 40 A	0 A to 40 A	0 A to 40 A	0 A to 40 A
Resolution	100 mA	100 mA	100 mA	100 mA
Deviation of peak current measurement	<2% of fs	<2% of fs	<2% of fs	<2% of fs
between 0°C and 45°C	<0.2%/°C	<0.2%/°C	<0.2%/°C	<0.2%/°C
General data				
Outputs	max. 120 V DC, floating			
Voltage compensation	1 V per lead (remote sensing)		1 V per lead (remote sensing)	
AC supply	100/120/220/240 V ±10%, 50 Hz to 60 Hz, 690 VA			
Dimensions (W × H × D); weight	211 mm × 150 mm × 350 mm; 8 kg			

### Ordering information

DC Power Supply	R&S®NGSM32/10	0192.0810.31
	R&S®NGSM60/5	0192.0810.61

Options		
19" Adapter (3 HU, 2.8 kg)	R&S®NGSM-B0	0192.0810.00
RS-232-C Interface for R&S®NGSM32/10	R&S®NGSM-B1	0192.0810.01
IEEE-488 Interface for R&S®NGSM32/10	R&S®NGSM-B2	0192.0810.02
RS-232-C Interface for R&S®NGSM60/5	R&S®NGSM-B3	0192.0810.03
IEEE-488 Interface for R&S®NGSM60/5	R&S®NGSM-B4	0192.0810.04



Contents Overview

Chapter Overview

Type Index

R&S Addresses



RF Step Attenuator R&S® RSP up to 2.7 GHz



Contents Overview

Chapter Overview

Type Index

R&S Addresses







Contents Overview

Chapter Overview

Type Index

R&S Addresses



## Contents of Chapter 11

Designation	Frequency range	Type	Page
<b>Attenuators</b>			
Precision Step Attenuator (IEC/IEEE bus)	DC to 2.7 GHz	R&S® RSP	410
RF Step Attenuator (IEC/IEEE bus)	DC to 5.2 GHz	R&S® RSG	
RF Step Attenuator (IEC/IEEE bus)	DC to 2.7 GHz	R&S® DPSP	
RF Step Attenuator (manual control)	DC to 2.7 GHz	R&S® DPS	
<b>RF Relay Matrix</b>	DC to 6 GHz	R&S® PSU	412
<b>Matching Pads, Attenuators, Terminations</b>			
Attenuators	DC to 12.4 GHz	R&S® DNF	413
High-Power Attenuators	DC to 6 GHz	R&S® RBU50, RBU 100, RDL50, RBS 1000	
Precision Termination	DC to 18 GHz	R&S® RNA	
Terminations	DC to 4 GHz	R&S® RNB, RAU	
Feedthrough Terminations	DC to 1 GHz	R&S® RAD, RAD50, RAD600	
Matching Pads	DC to 2.7 GHz	R&S® RAM, RAZ	
<b>Junction Boxes/Power Splitters</b>			
Power Splitter	DC to 2.7 GHz	R&S® RVZ	415
Power Splitter/Combiner	0.1 MHz to 400 MHz	R&S® DVS	
Four-Port Junction Box	DC to 1.5 GHz	R&S® DVU4	
<b>Adapters for RF Connectors</b>		N, BNC, 4.1/9.5, 7/16, Dezifix B	415
<b>Coaxial Components</b>			416
<b>Cabinets, designs</b>		Rohde&Schwarz offers an extensive range of accessories for all cabinet designs	417



Contents Overview

Chapter Overview

Type Index

R&S Addresses



## RF Step Attenuators R&S® RSP, R&S® RSG, R&S® DPSP, R&S® DPS

R&S® RSP



### Brief description

Attenuator sets are two-port networks providing adjustable attenuation and the same constant characteristic impedance at the input and output.

### Switching characteristics (R&S® RSP, R&S® RSG)

During the switch-on routine the attenuators are set to DC and an attenuation of 40 dB. During switchover between two attenuation values it is ensured that there will be no reduction to lower attenuation values. During switching off the maximum attenuation value is always obtained.

### Design (R&S® RSP, R&S® RSG)

R&S® RSP and R&S® RSG are accommodated in compact 19" cases. The connectors can be refitted from the front to the rear panel. Since the attenuator module is electrically isolated from the unit itself, the attenuator pads have no ground or AC supply connections.

### Main features (R&S® RSP, R&S® RSG)

- ◆ Lifetime >10 × 10<sup>6</sup> switching operations per step
- ◆ Low input and output reflection coefficient
- ◆ Connectors electrically isolated from chassis ground
- ◆ High setting accuracy and switching reliability
- ◆ Short setting time of 20 ms

- ◆ Residual attenuation taken into account
- ◆ Frequency-dependent attenuation correction (R&S® RSP)
- ◆ Programmable via IEC/IEEE bus

### RF Step Attenuator R&S® RSG

Attenuation can be set in 1 dB steps from 0 dB to 139 dB. The low residual attenuation with 0 dB setting can be determined by means of a special function. The attenuation accuracy can be improved by taking into account the correction values which are displayed on the front panel and can be recalled via IEC/IEEE bus.

### Precision Attenuator R&S® RSP

R&S® RSP provides attenuation values between 0 dB and 139.9 dB in the frequency range 0 Hz to 2.7 GHz. Above 1 dB, the smallest step is 0.1 dB. R&S® RSP can be used as an attenuator pad from 1 dB to 139.9 dB.

### R&S® DPSP

RF Step Attenuator R&S® DPSP allows manual settings with two rotary switches, the carry being executed automatically. For remote control, R&S® DPSP has an IEC/IEEE bus interface and can be used in automatic test systems.

R&S® DPSP can be mounted into 19" racks using an adapter. The connectors can be refitted from the front to the rear panel with no change of cables being involved.

### R&S® DPS

RF Step Attenuator R&S® DPS features manual operation and the same electrical characteristics as the programmable R&S® DPSP. The desired attenuation is set with decade switches. Built-in batteries, which are charged during AC supply operation, make R&S® DPS ideal for all applications where a power cable would be troublesome, e.g. in servicing and in outdoor measurements.



R&S® DPSP



R&S® DPS



Contents Overview

Chapter Overview

Type Index

R&S Addresses



## RF Step Attenuators R&S®RSP, R&S®RSG, R&S®DPSP, R&S®DPS

### Specs in brief

#### R&S®RSG

#### R&S®RSP

#### R&S®DPSP, R&S®DPS

Frequency range	0 Hz to 5.2 GHz		0 Hz to 2.7 GHz		0 Hz to 2.7 GHz	
Attenuation range	0 dB to 139 dB		0 dB to 139.9 dB		0 dB to 139 dB	
Smallest step	1 dB		0.1 dB (from 1 dB)		1 dB	
Residual attenuation (0 dB position)	DC	≤0.1 (typ. 0.05) dB	DC	≤0.12 (typ. 0.08) dB	≤200 MHz	≤0.4 dB
	≤1 GHz	≤0.8 (typ. 0.5) dB	≤1 GHz	≤1.2 (typ. 0.8) dB	≤1 GHz	≤0.8 dB
	≤3 GHz	≤1.2 (typ. 0.8) dB	≤2.7 GHz	≤1.8 (typ. 1.4) dB	≤2.7 GHz	≤1.2 dB
	≤5.2 GHz	≤1.6 (typ. 1.3) dB				
Maximum attenuation error (in dB + % of attenuation value)	≤1 GHz	±(0.2 dB + 1%)	≤1 GHz	±(0.2 dB + 1%)	±(0.2 dB + 1.3%), max. 1 dB	
	≤3 GHz	±(0.4 dB + 1%)	≤2 GHz	±(0.3 dB + 1%)	typ. ±(0.1 dB + 0.6%),	
	≤5.2 GHz	±(0.6 dB + 1.3%)	≤2.7 GHz	±(0.4 dB + 1%)	max. 0.5 dB	
Maximum attenuation error with correction			≤0.5 GHz	±(0.05 dB + 0.5%)	–	
			≤1 GHz	±(0.1 dB + 0.5%)		
			≤2 GHz	±(0.15 dB + 1%)		
Correction data stored for each attenuation setting	at 50 MHz intervals		at 50 MHz intervals		–	
VSWR	≤3.5 GHz	≤1.1 + 0.2 f/GHz	≤2 GHz	≤1.2 + 0.15 f/GHz	≤1.5 GHz	≤1.1 + 0.2 f/GHz
	≤5.2 GHz	≤1.8	≤2.7 GHz	≤1.5	≤2.7 GHz	≤1.4
Power-handling capacity						
Continuous	1 W		1 W		1 W	
Pulse	200 W		200 W		200 W	
Duty cycle	10 μs, max. 150 V		10 μs, max. 150 V		10 μs, max. 150 V	
Life	>10 × 10 <sup>6</sup> switching operations/step		>10 × 10 <sup>6</sup> switching operations/step		>10 × 10 <sup>6</sup> switching operations/step	
Switching time	≤20 ms (atten. not corrected)		≤20 ms (atten. not corrected)		≤20 ms	
Selftest	checking of correction values		checking of correction values			
Power supply	100/120/220/240 V ±10%, 47 Hz to 440 Hz		100/120/220/240 V ±10%, 47 Hz to 440 Hz		115/125/220/235 V ±10%, 47 Hz to 440 Hz	
Dimensions (W × H × D)	435 mm × 103 mm × 359 mm		435 mm × 103 mm × 359 mm		241 mm × 110 mm × 234 mm	
Weight	5.5 kg		5.5 kg		3 kg	

### Ordering information

<b>RF Step Attenuator</b>	1009.4505.02	0831.3515.02	R&S®DPSP: 0334.6010.02 R&S®DPS: 0334.7217.02
<b>Extras</b>	0358.5414.02	matching Pad RAM (50/75 Ω)	



Contents Overview

Chapter Overview

Type Index

R&S Addresses





Contents Overview

Chapter Overview

Type Index

R&S Addresses



## RF Relay Matrix R&S® PSU

DC to 6 GHz

RF Relay Matrix for IEC/IEEE bus programming



### Main features

- ◆ Six independent 50 Ω coaxial relays:
  - three with N connector up to 6 GHz,
  - three with BNC connector up to 500 MHz
- ◆ RF and pulse applications
- ◆ Easy to operate, LED indication
- ◆ Remotely controllable via IEC/IEEE bus

### Specifications in brief

	Relays 1 to 3	Relays 4 to 6
Connectors	50 Ω N female on front panel	50 Ω BNC female on rear panel
Frequency range	DC to 6 GHz	DC to 500 MHz
VSWR	<1.22 to 1 GHz	<1.1 to 100 MHz
Insertion loss	0.3 dB to 1 GHz	0.2 dB to 100 MHz
Crosstalk attenuation	>80 dB to 1 GHz	>40 dB to 100 MHz
Max. power-handling capacity	100 W at 0.1 GHz 50 W at 1 GHz	1 A at 28 V
Switching time	<25 ms	<7.5 ms
<b>General data</b>		
Lifetime	>1 000 000 switching operations	
Power supply	115/125/220/235 V ±10%, 47 Hz to 420 Hz; max. 25 VA	
Dimensions (W × H × D)	211 mm × 112 mm × 346 mm	
Weight	4.8 kg	

### Ordering information

RF Relay Matrix	R&S® PSU	0290.8014.02
-----------------	----------	--------------



Contents Overview

Chapter Overview

Type Index

R&S Addresses





Contents Overview

Chapter Overview

Type Index

R&S Addresses



## Matching Pads, Attenuators, Terminations



R&S® DNF



R&S® RNB



R&S® RNA



R&S® RAD (RAD50)



R&S® RAM (RAZ)



R&S® RBS1000



R&S® RDL50

R&S® RAU, 100W



### Brief description

#### Attenuators

Attenuators are ideal for use in test setups in which the attenuation values do not have to be frequently changed. Their compact design and ease of handling (easy to replace) makes them also highly suitable for use in mobile test setups.

#### High-power attenuators

These are used as dummy loads for transmitter and power amplifiers. They have a test output with exactly defined attenuation for the connection of a measuring instrument such as power meter, analyzer or counter.

#### Terminations

They provide reflection-free termination of instruments and cables and can also be used as a reference impedance for VSWR measurements. In contrast to high-power attenuators, terminations do not have a test output.

#### Matching pads, feedthrough terminations

Matching pads are used to provide the necessary matching between measuring instruments and transmission lines of different characteristic impedances or as feedthrough terminations for matching 50 Ω lines to measuring instruments of high input impedance.



Contents Overview

Chapter Overview

Type Index

R&S Addresses



## Specifications in brief/Ordering information for attenuators, terminations, matching pads

Designation	Type R&S® Order No.	Character- istic impedance	Power rating	Nominal insertion loss	Frequency range	VSWR	Accuracy of insertion loss	Max. peak pulse voltage	Connectors	Dimensions, weight
<b>Attenuators</b>	DNF 0272.4010.50	50 Ω	2 W <sup>1)</sup>	3 dB	0 to 12.4 GHz	≤1.1 (up to 4 GHz) ≤1.2 (up to 10 GHz) ≤1.25 (up to 12.4 GHz)	±0.3 dB up to 8 GHz <sup>2)</sup> ±0.5 dB up to 12.4 GHz <sup>2)</sup>		N male, N female	20.5 mm dia. × 55 mm, 69 g
	DNF 0272.4110.50			6 dB						
	DNF 0272.4210.50		1 W <sup>1)</sup>	10 dB			±0.3 dB up to 8 GHz <sup>2)</sup> ±0.6 dB up to 12.4 GHz <sup>2)</sup>			
	DNF 0272.4310.50			20 dB			±0.5 dB up to 4 GHz <sup>2)</sup> ±0.6 dB up to 8 GHz <sup>2)</sup> ±0.8 dB up to 12.4 GHz <sup>2)</sup>			
	DNF 0272.4410.50			30 dB			±1 dB up to 12.4 GHz <sup>2)</sup>			
<b>High-Power Attenuators</b>	RBU 50 1073.8695.03	50 Ω	50 W <sup>3)</sup>	3 dB	0 to 2 GHz	≤1.1	±0.5 dB up to 1.5 GHz ±0.75 dB up to 2 GHz	5 kW (1 μs, 1%)	N male, N female, to MIL-C39012	180 mm × 77 mm × 90 mm, 0.8 kg
	RBU 50 1073.8695.06			6 dB			±0.5 dB up to 1.5 GHz ±0.75 dB up to 2 GHz			
	RBU 50 1073.8695.10			10 dB			±1 dB up to 2 GHz			
	RBU 50 1073.8695.20			20 dB			±1 dB up to 2 GHz			
	RBU 50 1073.8695.30			30 dB			±1 dB up to 2 GHz			
	RBU 100 1073.8820.03	50 Ω	100 W <sup>3)</sup>	3 dB	0 to 2 GHz	≤1.1	±0.5 dB up to 1.5 GHz ±0.75 dB up to 2 GHz	5 kW (1 μs, 1%)	N male, N female, to MIL-C39012	236 × 140 mm × 141 mm, 2.8 kg
	RBU 100 1073.8495.06			6 dB			±0.5 dB up to 1.5 GHz ±0.75 dB up to 2 GHz			
	RBU 100 1073.8495.10			10 dB			±1 dB up to 2 GHz			
	RBU 100 1073.8495.20			20 dB			±1 dB up to 2 GHz			
	RBU 100 1073.8495.30			30 dB			±1 dB up to 2 GHz			
RDL50 1035.1700.52	50 Ω	50 W (input) 10 W (output)	20 dB	0 to 6 GHz	≤1.15 (up to 2 GHz)	±0.5 dB	2 kW/5 μs	N male, N female	114 mm × 89 mm × 68 mm, 0.5 kg	
RBS 1000 0207.4010.55	50 Ω	≤1000 W (≤600 W)	40 dB	0 to 0.4 GHz (1 GHz)	≤1.2 input	±1 dB <sup>4)</sup>	10 kW/1 μs	N female	500 × 285 mm × 152 mm, 12 kg	
<b>Terminations</b>	RNA 0272.4510.50	50 Ω ±1%	1 W <sup>1)</sup>		0 Hz to 18 GHz	≤1.02 (up to 1 GHz) ≤1.02 + 0.004 × f [GHz]			N male	21 mm dia. × 46 mm, 36 g
	RNA 1028.4994.72	75 Ω	1 W <sup>1)</sup>		0 Hz to 3 GHz	≤1.02			N male	21 mm dia. × 46 mm, 65 g
	RNB 0272.4910.50	50 Ω	1 W <sup>1)</sup> , 2 W peak		0 Hz to 4 GHz	≤1.05 (up to 1 GHz) ≤1.1 (up to 2 GHz) ≤1.2 (up to 4 GHz)			N male	20.5 mm dia. × 35 mm, 36 g
	RAU 0200.0019.55	50 Ω	100 W <sup>5)</sup>		0 Hz to 2 GHz	≤1.05 (up to 1 GHz) ≤1.1 (up to 1.5 GHz) ≤1.4 (up to 2 GHz)		2 kV	N female	95 mm × 152 mm × 235 mm, 2 kg
<b>Feedthrough terminations</b>	RAD 0289.8966.00	50 Ω	500 mW <sup>6)</sup>		0 Hz to 1 GHz	≤1.05 (up to 0.1 GHz) <sup>7)</sup> ≤1.1 (up to 0.5 GHz) ≤1.2 (up to 1 GHz)			BNC male, BNC female	14.5 mm dia. × 50.5 mm, 22 g
	RAD50 0844.9352.02	50 Ω	2 W		0 to 500 MHz	≤1.1 (up to 200 MHz) ≤1.25 (up to 500 MHz)			BNC male, BNC female	15.3 mm dia. × 50.5 mm, 22 g
<b>Matching pads</b>	RAM 0358.5414.02	50 Ω → 75 Ω	2 W <sup>8)</sup>	5.72 dB	0 to 2.7 GHz	≤1.06 (up to 2 GHz) ≤1.2 (up to 2.7 GHz), both terminals	+ 0.15/-0.05 dB		N male, N female, on 75 Ω end	21 mm dia. × 73 mm, 105 g
	RAZ 0358.5714.02			1.76 dB		≤1.06 (up to 2 GHz) ≤1.2 (up to 2.7 GHz), at 75 Ω terminal	±0.2 dB			

1) At a max. ambient temperature of 30°C; decreasing linearly to 0 W at 130°C.  
 2) Attenuation change at a temperature change of 1 K: ≤0.0001 dB/dB. At a load change of 1 W: ≤0.001 dB/dB.  
 3) Continuous load up to a max. ambient temperature of 20°C, decreasing linearly to 0 W at 125°C; power-handling capacity at output up to 20 W.  
 4) The frequency response of the insertion loss is specified on a label on R&S®RBS 1000 as 0.1 dB measurement error.  
 5) Overload capacity 100% (max. 5 s).  
 6) Continuous load up to a max. ambient temperature of 70°C; decreasing linearly to 0 W at 130°C.  
 7) Measured with open-circuit output.  
 8) Ambient temperature 25°C.

## Junction Boxes/Power Splitters



R&S® DVS

### Power Splitter/Combiner R&S® DVS

- ◆ Distribution or combination of signals
- ◆ High isolation between inputs
- ◆ Low insertion loss

#### Specifications in brief

Frequency range	0.1 MHz to 400 MHz
Characteristic impedance	50 Ω
VSWR	typ. 1.2 dB
Insertion loss	typ. 3 dB
Isolation between inputs	20 dB to 40 dB
Max. continuous load	1 W = 7 V into 50 Ω
Dimensions	57 mm × 36 mm × 41 mm

#### Ordering information

<b>Power Splitter/Combiner</b>	R&S® DVS	0342.1014.50
--------------------------------	----------	--------------



R&S® DVU 4

### Four-Port Junction Box R&S® DVU 4

- ◆ Four-port junction box for splitting up into or combining three channels with correct impedance matching
- ◆ For use e.g. in 3-signal measurements on radiotelephone equipment

#### Specifications in brief

Frequency range	0 Hz to 1500 MHz
Impedance	50 Ω
SWR	<1.1 (up to 1 GHz) typ. 1.2 (up to 1.5 GHz)
Insertion loss	9.5 dB
Max. load per connector	0.25 W
Max. permissible-voltage spikes	300 V
Connectors	N female
Dimensions	120 mm × 120 mm × 35 mm

#### Ordering information

<b>Four-Port Junction Box</b>	R&S® DVU 4	0201.4018.03
-------------------------------	------------	--------------

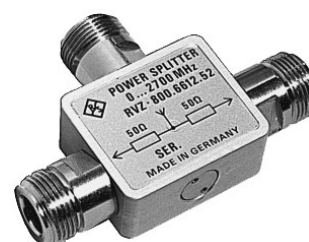

R&S® RVZ

### Power Splitter R&S® RVZ

- ◆ Power distribution to signal paths of exactly the same waves
- ◆ Measurement of correct transmission factor (reference: forward wave)

#### Specifications in brief

Frequency range	0 Hz to 2700 MHz
Impedance	50 Ω
SWR	≤1.1
Output level deviation	≤0.1 dB
Output phase deviation	≤2°
Insertion loss from input to each output	6 dB -0.1/+0.5 dB
Power-handling capacity	1 W
Connectors	N female
Dimensions	47 mm × 70 mm × 16 mm

#### Ordering information

<b>Power Splitter</b>	R&S® RVZ	0800.6612.52
-----------------------	----------	--------------

## Adapters for RF Connectors

All RF connectors can be adapted for use in other systems by means of screw-in connectors, see table on the right. The maximum power values for frequencies other than 1000 MHz are obtained by means of the following formula:

$$P_{\max} = P_{(1 \text{ GHz})} / \sqrt{f_{(\text{GHz})}}$$

Conversion to	Male connector	Female connector	Max. power at 1 GHz
N	017.7532.00	017.5398.00	0.6 kW
BNC	017.7832.00	017.5730.00	0.4 kW
4.1/9.5	017.9106.00	017.8516.00	0.8 kW
7/16	017.9258.00	017.8739.00	1.0 kW
Dezifix B	018.2486.00	018.2486.00	1.3 kW



Contents Overview

Chapter Overview

Type Index

R&S Addresses



## Coaxial Components

### Brief description

Measuring instruments from Rohde&Schwarz are fitted with internationally used standard connectors. Depending on the requirements

(frequency range, power rating, reflection characteristics, etc), connector systems N, PC-3.5 or BNC are used.

The following overview also shows the most frequently required couplings, angle junctions and T connectors.

### Note

Order numbers are bold-faced.

### Adapters to systems of other make

50 Ω N female/ BNC male	50 Ω N male/ BNC female	Screw-in connector 4/13 male/ BNC female	4/13 female/ BNC male	4/13 male/ BNC female	BNC male/ knurled terminal	BNC male/ dual knurled terminal
<b>0541.8030.00</b>	<b>0118.2812.00</b>	<b>0017.5975.00</b>	<b>0408.4509.00</b>	<b>0408.4480.00</b>	<b>0541.8030.00</b>	<b>0017.6742.00</b>

### Couplings, angle junctions and T connectors, 50 Ω

N male/ male	N female/ female	BNC female/ female	N male/ female	N female-female/ male	BNC female-female/ male
<b>0092.6581.00</b>	<b>0092.6700.00</b>	<b>0017.6559.00</b>	<b>0018.4495.00</b>	<b>0018.4537.00</b>	<b>0017.6588.00</b>

### Shortcircuits

### Cable-mounting connectors (male)

N connector (male)	N connector (female)	For cable RG 58 C/U RG 8/213/214U	N, 50 Ω	BNC, 50 Ω
<b>0017.8080.00</b>	<b>0017.8145.00</b>		<b>0472.9714.00</b> <b>0415.9502.00</b>	<b>0017.6536.00</b> <b>0017.6442.00</b>



Contents Overview

Chapter Overview

Type Index

R&S Addresses







Contents Overview

Chapter Overview

Type Index

R&amp;S Addresses



## Cabinets, designs

### Dimensions

The dimensions of Rohde & Schwarz instruments are specified as follows:

Overall width × height × depth in mm, looking onto the front panel (this also holds for pocket-size instruments). Dimensions generally refer to bench models.

### Cabinet designs

Cabinet design must meet all the criteria that mature electronic packaging has to fulfill. Changing requirements regarding technology and environment call for new cabinet designs and systems.

Rohde & Schwarz uses the following two design forms for its products:

- ◆ design 2000 (BW2000)
- ◆ compact design 90 (KB90)

### Rackmounting

Rohde & Schwarz instruments in the above cabinet design can be mounted into 19" racks with the aid of appropriate adapters. It may be necessary to retrofit the racks accordingly.

### Design 2000 (BW2000)

Design 2000 is a standardized cabinet system suitable for bench models, for mobile use and for mounting in 19" racks. With only a few basic elements, a variety of cabinets can be implemented from one to six height units and in different widths and depths.



*Design 2000*

With the

- ◆ iF Product Design Award 1998 and
- ◆ iF Ecology Design Award 1998

received from Industrie Forum Design Hanover, design 2000 has been attested excellent design that takes account of all environmental and recycling criteria for product design.

### Construction

The sturdy construction of design 2000 essentially consists of a chassis, an enclosure, feet and front handles.

The chassis is made up of an aluminium-cast front frame and a sheet-metal module support including rear panel. To enclose the instrument, the enclosure is slid over the chassis from the rear and fixed by means of rear-panel feet with elastic pads. The bottom feet with antislid protection are screwed to the enclosure and serve at the same time as a locking device for stacking units.

Compared to previous designs, design 2000 features further improved shielding. The few interfaces between the cabinet parts can be sealed with braided cords and spring strips where required.

### Options

The cabinets can optionally be fitted with side handles and tilt feet. Special shock-absorbing parts for the front and rear panel as well as a swivel carrying handle that can also be used as a stand are available for mobile use.



Contents Overview

Chapter Overview

Type Index

R&amp;S Addresses



## Cabinets, designs

### Compact design 90 (KB90)

#### Construction

The design 90 cabinet consists of a self-supporting aluminium-cast frame with front and rear panels and top and bottom covers which make up the panelling. The panelling is fixed and the instrument thus enclosed by screwing two feet (4 screws) to the rear panel. The cabinet is completed by attaching feet at the bottom and on the sides. Depending on the type of equipment, one or two carrying straps fixed on the sides make for portability of the instruments.

The tilt stands at the bottom allow the instrument to be set up in a position for convenient operation.

#### System compatibility

The compact units of design 90 can be stacked with each other as well as with 19" units of previous designs. The bottom feet serve for stacking the units to form a system.



*The compact cabinets of design 90 can be stacked not only with one another but also with 19" cabinets of the preceding cabinet designs*

### Installation in 19" racks

Rohde&Schwarz instruments of design 2000 or compact design 90 can be installed in 19" racks with the aid of appropriate adapters. It might be necessary to retrofit the racks accordingly.

With the 19" adapters from Rohde&Schwarz a wide variety of rackmounting combinations can be implemented, even different types of cabinet can be combined ( $\frac{1}{2}$  width).

Additional adapter sets are available for rackmounting by means of telescopic rails. For mounting the appropriate 19" adapter all that is required is to remove a few elements, e.g. the instrument's feet. The scope of supplies includes comprehensive mounting instructions plus the mechanical parts and fixing elements.

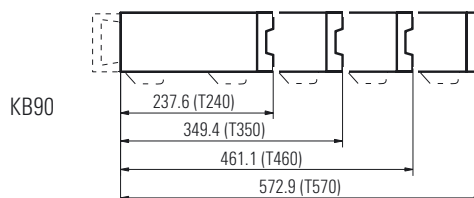
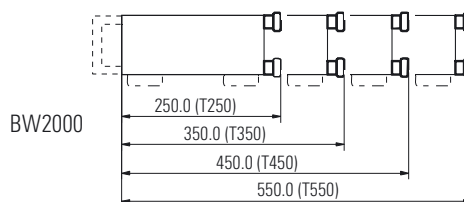
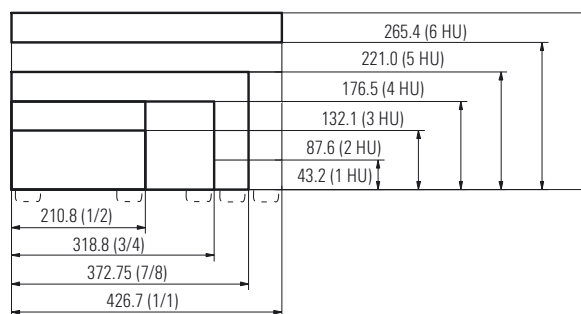



Contents Overview

Chapter Overview

Type Index

R&S Addresses



## Cabinets, designs

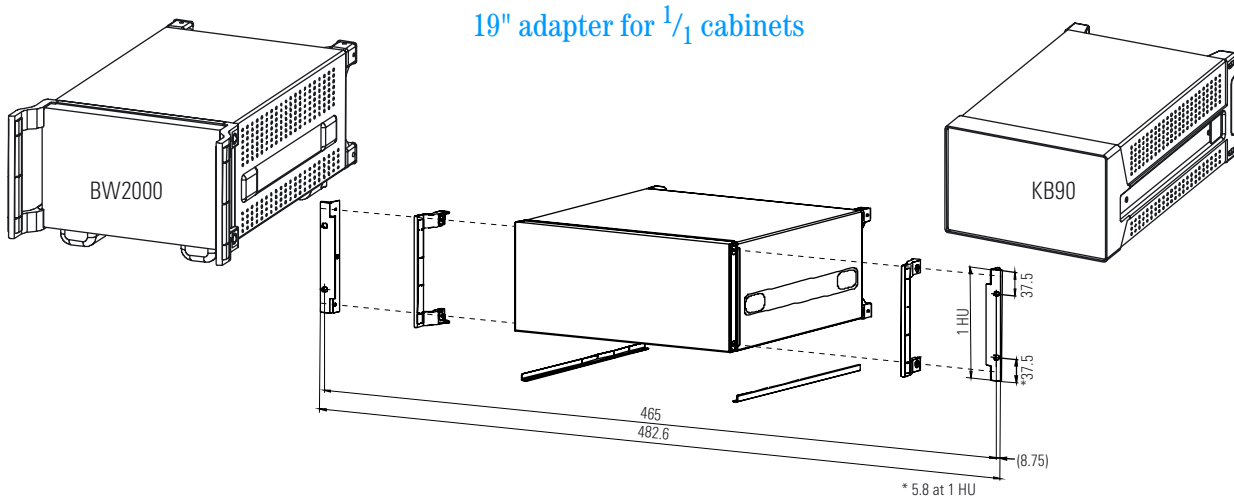

E	Type	Order number
1	R&S®ZZA-111	1096.3254.00
2	R&S®ZZA-211	1096.3260.00
3	R&S®ZZA-311	1096.3277.00
4	R&S®ZZA-411	1096.3283.00
5	R&S®ZZA-511	1096.3290.00
6	R&S®ZZA-611	1096.3302.00

E	Type	Order number
1	R&S®ZZA-91	0396.4870.00
2	R&S®ZZA-92	0396.4886.00
3	R&S®ZZA-93	0396.4892.00
4	R&S®ZZA-94	0396.4905.00
5	R&S®ZZA-95	0396.4911.00
6	R&S®ZZA-96	0396.4928.00

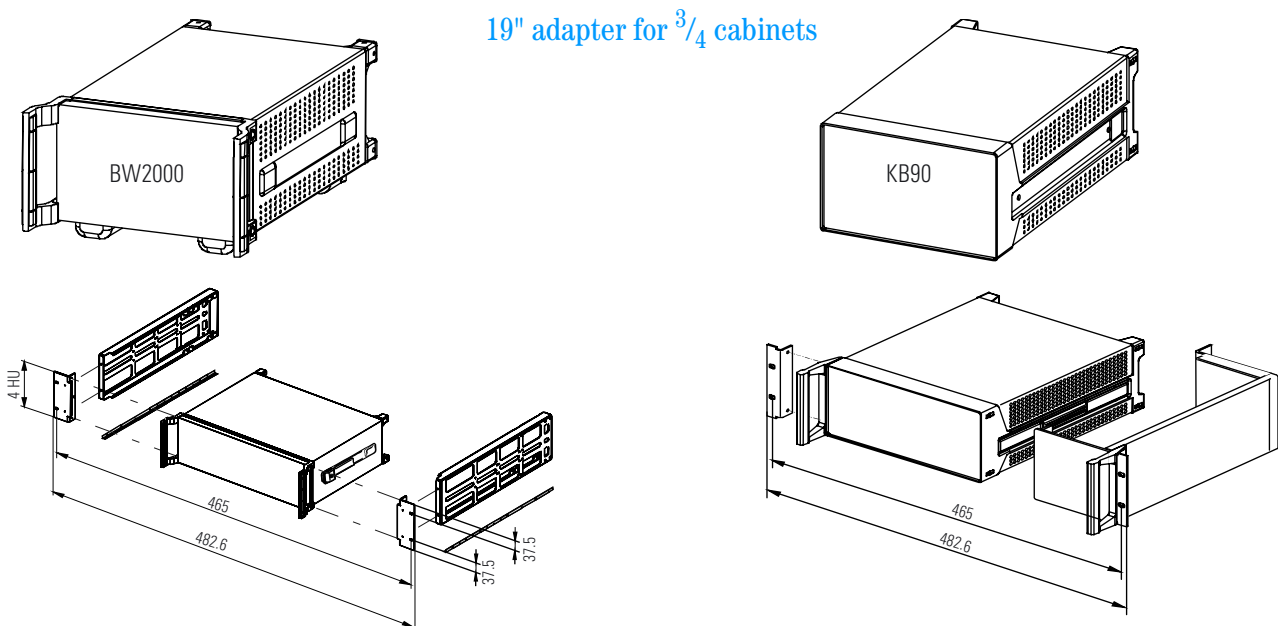

E	Type	Order number
3	R&S®ZZA-334	1096.3219.00

E	Type	Order number
4	R&S®ZZA-99	0839.5775.00



Contents Overview

Chapter Overview

Type Index

R&S Addresses





Contents Overview

Chapter Overview

Type Index

R&S Addresses



## Cabinets, designs

### 19" adapter for 7/8 cabinets

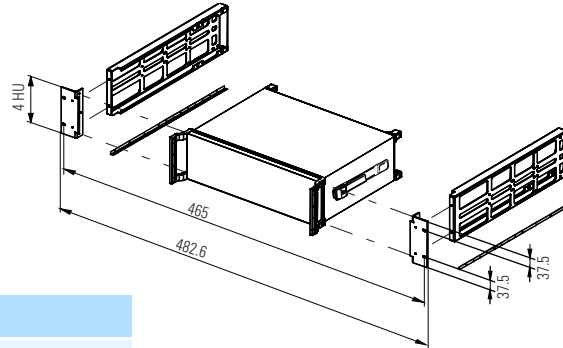
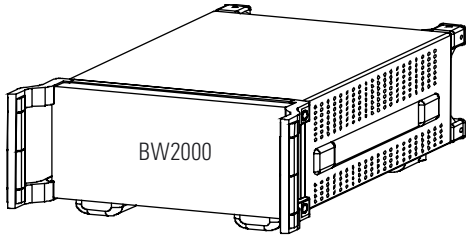

E	Type	Order number
4	R&S®ZZA-478	1096.3248.00

### 19" adapter for 1/2 cabinets

#### Possible combinations

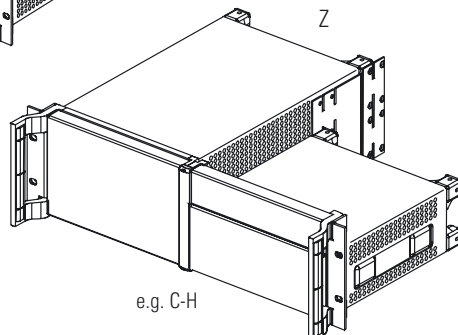
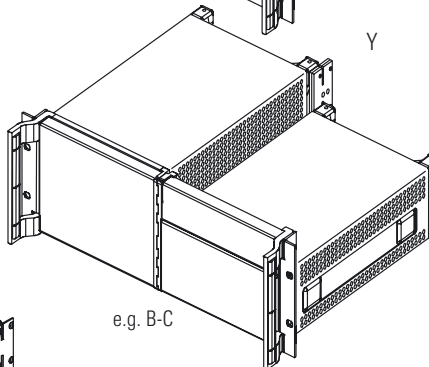
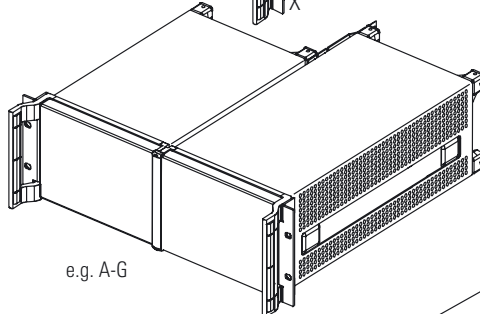
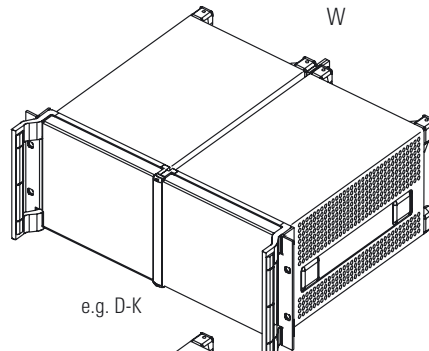
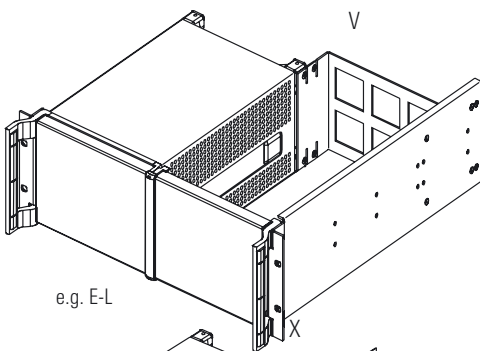

Contents Overview

Chapter Overview

Type Index

R&S Addresses





Contents Overview

Chapter Overview

Type Index

R&S Addresses



## Select cabinet combination

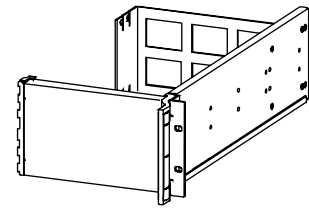
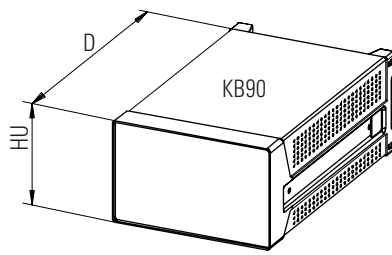
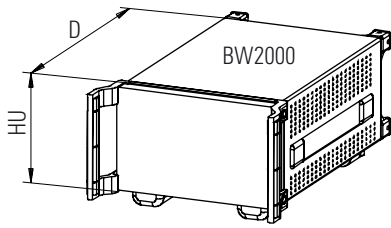

Height in mm (HU)	Depth in mm (T)	Cabinet
88 (2 HU)	222 (T250)	A
88 (2 HU)	322 (T350)	B
88 (2 HU)	422 (T450)	N
132 (3 HU)	322 (T350)	C
132 (3 HU)	422 (T450)	D
132 (3 HU)	422 (T460)	E

Height in mm (HU)	Depth in mm (T)	Cabinet
88 (2 HU)	209 (T240)	F
88 (2 HU)	321 (T350)	G
88 (2 HU)	433 (T460)	H
132 (3 HU)	321 (T350)	J
132 (3 HU)	432 (T460)	K

	Cabinet
Empty cabinet	L



Contents Overview

Chapter Overview

Type Index

R&S Addresses





Contents Overview

Chapter Overview

Type Index

R&S Addresses



Select cabinet combination

e.g. combination C-L



	A	B	C	D	E	F	G	H	J	K	L	M	N	
A	3	8	17	18	19	5	6	6	21	21	1			
B	8	3	14	17	20	7	5	6	15	21	1			
C	17	14	4	12	13	22	16	23	9	10	2			
D	18	17	12	4	4	22	22	16	11	9	2			
E	19	20	13	4	4	22	22	16	11	9	2			
F	5	7	22	22	22	24	24	24	25	25	24			
G	6	5	16	22	22	24	24	24	25	25	24		29	
H	6	6	23	16	16	24	24	24	25	25	24			
J	21	15	9	11	11	25	25	25	25	25	25		28	
K	21	21	10	9	9	25	25	25	25	25	25			
L	1	1	2	2	2	24	24	24	25	25			1	
M												26	27	30
N							29		28		1	30	3	

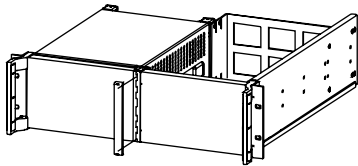

Select #2 from left table below

(Rohde&Schwarz Order number 1109.4164.00)



#	Rohde&Schwarz Order number	Description	See cabinets on page 420
1	1109.4158.00	19" adapter 1/2 Type 1	V
2	1109.4164.00	19" adapter 1/2 Type 2	V
3	1109.4170.00	19" adapter 1/2 Type 3	W
4	1109.4187.00	19" adapter 1/2 Type 4	W
5	1109.4193.00	19" adapter 1/2 Type 5	W
6	1109.4206.00	19" adapter 1/2 Type 6	X
7	1109.4212.00	19" adapter 1/2 Type 7	X
8	1109.4229.00	19" adapter 1/2 Type 8	X
9	1109.4235.00	19" adapter 1/2 Type 9	W
10	1109.4241.00	19" adapter 1/2 Type 10	X
11	1109.4258.00	19" adapter 1/2 Type 11	X
12	1109.4264.00	19" adapter 1/2 Type 12	X
13	1109.4270.00	19" adapter 1/2 Type 13	X
14	1109.4287.00	19" adapter 1/2 Type 14	Y
15	1109.4293.00	19" adapter 1/2 Type 15	Y

#	Rohde&Schwarz Order number	Description	See cabinets on page 420
16	1109.4306.00	19" adapter 1/2 Type 16	Y
17	1109.4312.00	19" adapter 1/2 Type 17	Z
18	1109.4329.00	19" adapter 1/2 Type 18	Z
19	1109.4335.00	19" adapter 1/2 Type 19	Z
20	1109.4341.00	19" adapter 1/2 Type 20	Z
21	1109.4358.00	19" adapter 1/2 Type 21	Z
22	1109.4364.00	19" adapter 1/2 Type 22	Z
23	1109.4370.00	19" adapter 1/2 Type 23	Z
24	0827.4527.00	R&S®ZZA-97 19" adapter 2E 1/2	V/W/X
25	0827.4533.00	R&S®ZZA-98 19" adapter 3E 1/2	V/W/X/Y/Z
26	1109.4387.00	19" adapter 1/2 Type 26	V
27	1109.4393.00	19" adapter 1/2 Type 27	W
28	1109.4406.00	19" adapter 1/2 Type 28	Z
29	1109.4412.00	19" adapter 1/2 Type 29	X
30	1109.4429.00	19" adapter 1/2 Type 30	X



Contents Overview

Chapter Overview

Type Index

R&S Addresses





Contents Overview

Chapter Overview

Type Index

R&S Addresses



## Cabinets, designs

### Adapter for telescopic rails (only in conjunction with 19" adapter)

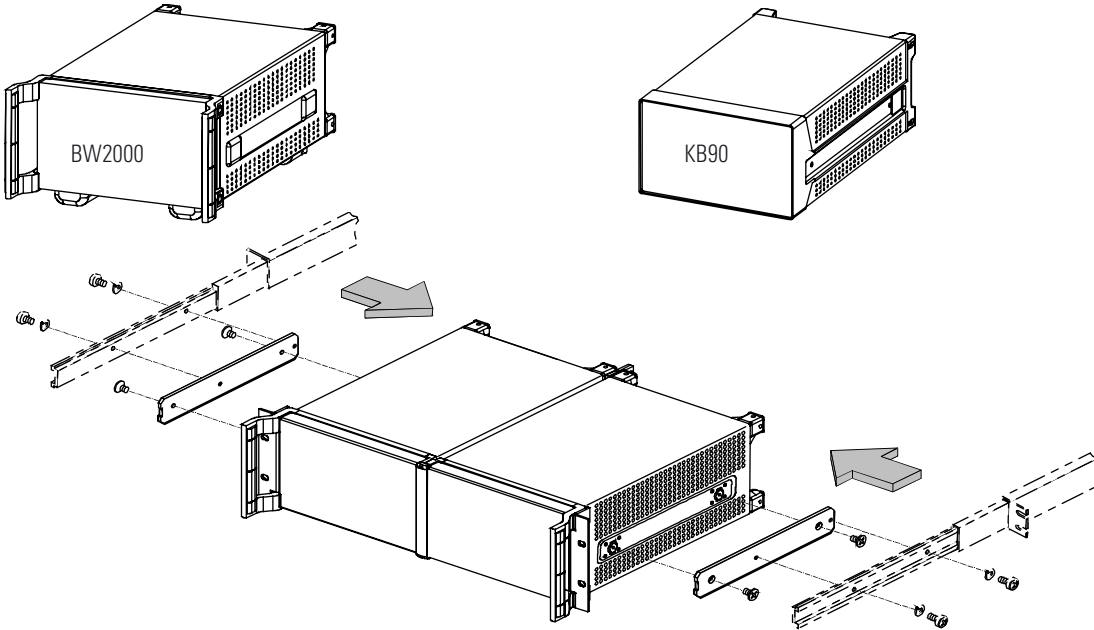

Height (HU)	Depth (T)	Type	Order number
1	T350	R&S®ZZA-T13	1109.3739.00
	T450	R&S®ZZA-T14	1109.3745.00
2 to 6	T350	R&S®ZZA-T35	1109.3768.00
	T450	R&S®ZZA-T45	1109.3774.00
	T550	R&S®ZZA-T55	1109.3780.00

Height (HU)	Depth (T)	Type	Order number
1	T350	R&S®ZZA-913	0396.5430.00
	T460	R&S®ZZA-914	0396.5460.00
2 to 6	T350	R&S®ZZA-923	0396.5476.00
	T460	R&S®ZZA-924	0396.5482.00
	T570	R&S®ZZA-925	0396.5499.00



Contents Overview

Chapter Overview

Type Index

R&S Addresses



[Contents Overview](#)[Chapter Overview](#)[Type Index](#)[R&S Addresses](#)

## Rohde & Schwarz Customer Service



## Contents of Appendix

Subject, designation	Page
<b>Service and Calibration</b>	425
<b>Calibration</b>	427
<b>Information Resources</b>	428
<b>Training</b>	429
<b>Ownership Options, Trademarks</b>	431
<b>Key Rohde &amp; Schwarz Facilities</b>	432
<b>Address List</b> Address list for finding your nearest Rohde & Schwarz representative	433
<b>Index</b> Type/Data Sheet Index	438

[Contents Overview](#)[Chapter Overview](#)[Type Index](#)[R&S Addresses](#)





Contents Overview

Chapter Overview

Type Index

R&amp;S Addresses



## Service and Calibration

### Worldwide service

**As one of the world's leading manufacturers of test & measurement equipment, Rohde & Schwarz also maintains a world-class service network.**

T&M equipment and systems from Rohde & Schwarz offer the utmost in precision and accuracy. To make sure that customers can rely on this accuracy at all times, we have built a service network that ensures global access to expert calibration and maintenance, as well as any repair needs.

### Globally local

The Rohde & Schwarz service network is designed to be multilevel and decentralized. This means that all of our equipment and systems can be fully serviced by area support and local service centers, and do not have to be sent elsewhere except in only the most exceptional circumstances. For customers, this means minimal downtime and maximum availability.

Our service network has three hierarchical levels.

### The local service center – your partner close by

Each local service center provides a wide range of services tailored to local requirements. The great majority use standardized ACS 100 series test and calibration systems, providing automatic diagnostics, fast repair and calibration. All local service centers are equipped to provide the services typically required by the customers in their area.

### The area support center – expert technical knowledge and logistical backup

Located in the key industrial regions of the globe, these facilities have the resources to assist customers at virtually any level. Engineers are on call, and generous stocks of parts are on hand, as is all the equipment needed for advanced diagnostics, repair and calibration. Rohde & Schwarz area support centers are found in:

- ◆ Beijing, PRC
- ◆ Columbia, MD, USA
- ◆ São Paulo, Brazil
- ◆ Singapore
- ◆ Tokyo, Japan

### The Cologne and Munich service centers

Our service centers in Cologne and Munich, Germany are at the core of our worldwide service system. They back up our area support and local service centers with wide-ranging support, training, documentation and other services. They also function as area support centers for Europe, providing logistical support, high-level troubleshooting, maintenance, repair and calibration.

### Maximum availability

Working together, this network assures our customers of minimum downtimes and maximum availability. Whether for safety-critical applications or in cost-intensive production, Rohde & Schwarz customers know they can rely on our service network to keep their equipment at the highest level of precision.

### Consistently high standards

All of our service centers are internally audited to stringent quality standards. Our staff undergoes continuous and extensive training on the latest product developments, technologies and procedures. This ensures that Rohde & Schwarz customers the world over have local access to the same consistently high level of expertise.

### Flexible service options

Each customer has different needs. Therefore we offer a variety of flexible repair, maintenance, and calibration options, from pay-as-you-go to service contracts.



Contents Overview

Chapter Overview

Type Index

R&amp;S Addresses





Contents Overview

Chapter Overview

Type Index

R&S Addresses



# ROHDE & SCHWARZ Global Service Network



Contents Overview

Chapter Overview

Type Index

R&S Addresses





Contents Overview

Chapter Overview

Type Index

R&amp;S Addresses



## Calibration

**Quality management systems such as ISO9000 ff mandate the use of traceable calibrated measurement systems in development, production, and service**

Increasingly strict product liability regulations, quality management systems, and best practice all require that measurement systems be regularly calibrated.

Rohde&Schwarz service centers around the world carry out calibration to customer order, documented with calibration certificates complying with the required standards. We guarantee traceability to national or international standards. Test parameters for which national standards are not available are traced to basic parameters using approved methods.



### Calibration of the highest order

Our service centers use the R&S® ACS 100 calibration system, featuring:

- ◆ Precision
- ◆ Automatic test runs
- ◆ Uniform test reports
- ◆ Universal use
- ◆ Mobile use

This means that our customers the world over are assured of a uniformly high standard of calibration.

In addition to our worldwide local service centers, we maintain calibration laboratories of the German Calibration Service (DKD) at three locations in Germany. These laboratories are accredited by the German Standards Laboratory (PTB) in compliance with DIN EN 45001, and are subject to continuous supervision by the accrediting authority. A mobile DKD calibration laboratory enables us to offer on-site calibrations to this standard.

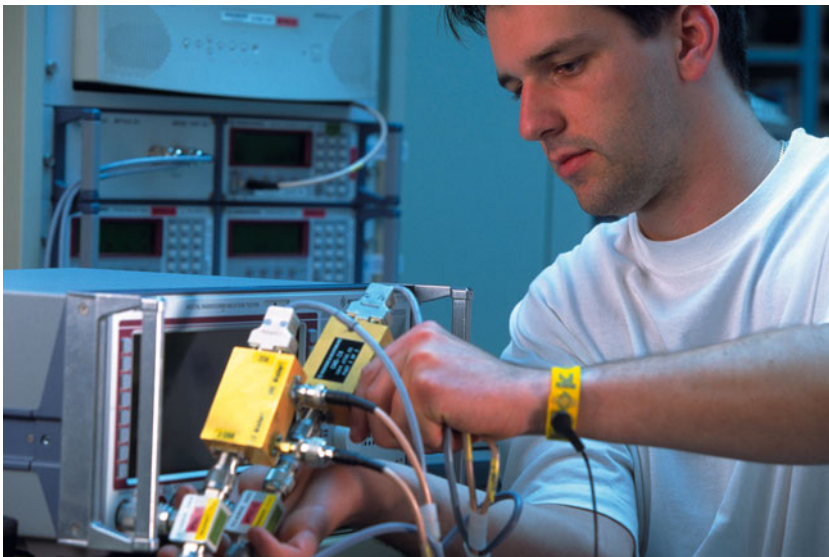

Contents Overview

Chapter Overview

Type Index

R&amp;S Addresses





Contents Overview

Chapter Overview

Type Index

R&amp;S Addresses



## Information Resources

**We back up our technology solutions with exhaustive information in many forms, so that you always have access to what you need**

### Hotline help

We offer expert hotline help. That means when you call us with a question, you talk to a qualified engineer who can give you real answers:

- ◆ Are you looking for a special type of instrument?
- ◆ Do you need help implementing remote control processes for production test equipment?
- ◆ Do you have a question about operating an instrument?
- ◆ Or anything else...

Ask us a question, and we'll give you an answer – it's as simple as that. Contact:

- ◆ Local service center
- ◆ Area support center
- ◆ +49 180 512 4242,  
fax +49 89 4129 13 777



You can also send us a mail at

**customersupport@rohde-schwarz.com.**

If an immediate answer is not possible, we won't waste your time with unnecessary calls or holding patterns. Instead, we'll record your problem, work on it, and get back to you.

If you are already a customer, your local service center will often be the fastest source of information – they already know your requirements and applications in more detail.

### Catalogs

In addition to this catalog, we offer:

- ◆ The World of Radiocommunications
- ◆ Sound and TV Broadcasting
- ◆ Radiomonitoring and Radiolocation
- ◆ HF–VHF/UHF–SHF Antennas
- ◆ EMC Test & Measurement

### Data sheets

These give a detailed description of each instrument, with features, applications and specifications. You can find the data sheet reference numbers for each instrument in the Type/Data Sheet Index starting on page 438. All data sheets are also available as pdf files on our website.

### News from Rohde & Schwarz

This journal is published four times a year in English, French, German, Chinese and Russian, and informs subscribers on new product developments, articles from the development lab, and test hints for specific instruments. The Type/Data Sheet Index starting on page 438 shows you the issues containing information on specific instruments. Back issues are available on the Web.

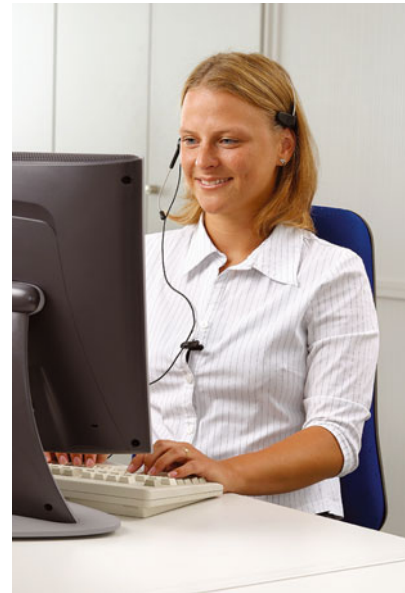

If you'd like to subscribe, contact your local Rohde & Schwarz sales engineer.

### Application notes

These give you valuable information on specific applications. All our application notes are free of charge and can be downloaded from our website.

### Special publications

Additional technical literature from Rohde & Schwarz is available in the form of special publications on current items, refresher topics, books, compendia etc.

Contact your local Rohde & Schwarz sales engineer.

### Website

Our website contains a vast amount of material, including detailed product information, much of which is downloadable as pdf files. You can also get a personal newsletter sent to you automatically, with information on your topics of interest.

**www.rohde-schwarz.com**



Contents Overview

Chapter Overview

Type Index

R&amp;S Addresses





Contents Overview

Chapter Overview

Type Index

R&amp;S Addresses



## Training

**By building your staff's expertise, you build your company's competitiveness. We can be a valuable part of that effort.**

Electronics is a complex field, requiring highly qualified staff. Rohde&Schwarz offers knowledge transfer at every level, from seminars on basic principles to advanced training on instruments and systems, according to customer requirements.

Our training is designed to help customers help themselves, with the focus on actionable knowledge and hands-on practice. Our seminars are constantly updated to meet the latest requirements.

### Small groups for big results

The number of participants is limited for all seminars. This ensures that every attendee gets maximum benefit, and allows an intensive dialog between trainer and trainee. Knowledge can be passed on in greater depth, and individual problems dealt with in greater detail. Most seminars include hands-on exercises on the latest test equipment, for most efficient learning.



### Effective training staff

Our communications, electrical and software engineers and physicists provide you with the knowledge you need. They have the latest know-how and years of experience, and just as importantly, they have the skills to pass on this knowledge in an interesting and engaging way. We attach the utmost importance to training them in effective teaching skills.

Where appropriate, we call in university lecturers, representatives of standards bodies and government authorities, and users. In each instance, we make sure that our customers have the best trainers available.

### Up-to-date material

All seminars are continually reviewed and improved, and new knowledge and relevant changes are incorporated immediately. This ensures that the technical knowledge, regulations, and standards specifications in the course material are always up to date.



Contents Overview

Chapter Overview

Type Index

R&amp;S Addresses



[Contents Overview](#)[Chapter Overview](#)[Type Index](#)[R&S Addresses](#)

## Training

### Standard seminars

Our standard seminars deal with the most commonly encountered measurement issues. Their focus is on the customer perspective, instead of on Rohde&Schwarz test assemblies.

Our course offerings are structured so that newcomers and specialists alike will find seminars to suit their needs.

### Customer-specific seminars

We offer tailor-made seminars for training the tasks performed at your company. We start with an analysis of the learning objectives and target group, and provide instruction using a tried-and-tested methodological approach. This ensures an optimum cost/benefit ratio and avoids burdening courses with unnecessary information. Within the framework of these seminars we also offer special user and application courses for Rohde&Schwarz instruments, so that your staff can make the most time-saving and efficient use of our equipment.

### Training locations

We hold seminars at our Munich headquarters and Cologne plant in Germany, at our branch offices around the world, and on-site at the customer's facility.

### Seminars at Rohde&Schwarz – knowledge at the source

Highly qualified personnel and a complete range of measuring instruments and teaching aids make each seminar a success. Here you can get acquainted with state-of-the-art measurement and communications technology right at the source.

### Seminars at the customer site – focused on you

Do you want to train several staff members at the same time? Do you prefer to put learning to use immediately? Do you need to solve specific problems within the organization? Or do you simply prefer to leave the travelling to us? We're glad to hold seminars at your facility, whether

standard Rohde&Schwarz seminars or tailor-made courses.

To find out more about our training, get a schedule of courses and specifics on contents, dates, pricing and more, contact your nearest sales office (address list on page 433) or look on the Internet.

[Contents Overview](#)[Chapter Overview](#)[Type Index](#)[R&S Addresses](#)

[Contents Overview](#)[Chapter Overview](#)[Type Index](#)[R&S Addresses](#)

## Ownership Options, Trademarks

### What you need, when you need it

**Rohde & Schwarz offers a variety of ways to acquire our equipment when you need it, without placing undue strain on your liquidity**

#### Rental with purchase option

Do you need an instrument only temporarily? Are you unsure as to your future plans? Or do you have to bridge a momentary financial bottleneck? Business is not always predictable, so we offer a rental with purchase option. For details and terms please contact your local Rohde&Schwarz representative.

### Leasing

If you're in the process of making other long-term investments, leasing our instruments is a good way to benefit from state-of-the-art Rohde&Schwarz technology without restricting your financial room to maneuver.

We cooperate with well-established financial institutions to offer you a wide range of leasing plans. You can make the necessary investments immediately, without impinging on tight budgets or having to put off acquisitions until the next fiscal period.

In many circumstances, leasing also brings tax benefits, since lease payments are immediately and fully tax-deductible in many places.

### Demo units

We offer demo units at very favourable prices. These instruments have seen little use and are in excellent condition. As a matter of course, demo units are thoroughly checked before leaving our premises, and we grant full warranty on them.

#### Service and calibration contracts

You can purchase repair services from us on a per-event basis, or in the form of a service contract which extends the warranty period to three years. The contract price includes all services necessary to restore the instrument to proper operating condition.

Regular calibration and maintenance services can likewise be purchased by contract. Contact your local service center to find out more.

## Trademarks

**Trade names are trademarks of the owners**

- ◆ R&S® is a registered trademark of Rohde&Schwarz GmbH & Co.KG  
Example: Test Receiver R&S®EFA
- ◆ The *Bluetooth* word mark and logos are owned by the Bluetooth SIG, Inc. and any use of such marks by Rohde&Schwarz is under license
- ◆ Windows is a registered trademark of Microsoft Corp., USA

[Contents Overview](#)[Chapter Overview](#)[Type Index](#)[R&S Addresses](#)

[Contents Overview](#)[Chapter Overview](#)[Type Index](#)[R&S Addresses](#)

## Key Rohde & Schwarz Facilities

**As a globally active company, Rohde & Schwarz has facilities around the world.**

### Headquarters

#### Munich, Germany

This is the home of R&D, systems engineering, worldwide training and service, and central administration.

### Area support centers

#### Beijing, China

Rohde & Schwarz China Ltd. supports users in China. Another office in Shenzhen ensures close contact with the booming industries of Southeastern China.

#### Cologne, Germany

The Rohde & Schwarz facility in Cologne is one of Europe's largest service centers for electronic T&M and communications equipment, and is an accredited calibration laboratory of the German Calibration Service (DKD). This facility is also home to training, technical documentation, logistics, and IT and communications project services.



#### Columbia, MD, USA

Rohde & Schwarz, Inc. supports our many customers in the key US and Canadian markets.

#### São Paulo, Brazil

Rohde & Schwarz do Brasil Ltda. provides support to customers in Latin America.

#### Singapore

Rohde & Schwarz Systems & Communications Asia Pte. Ltd. supports our customers in Southeast Asia, Australia, New Zealand and Korea.

#### Tokyo, Japan

Rohde & Schwarz Support Center Japan provides support to our customers in this market.

### Local service centers

Please see page 433 for a complete list of our offices.

### Manufacturing plants

#### Memmingen, Germany

The plant in Memmingen is responsible for the final production, inspection and delivery of most Rohde & Schwarz equipment.



#### Teisnach, Germany

This Rohde & Schwarz plant produces most of the mechanical and electrical components of our equipment used in the Memmingen and Vimperk plants.



#### Vimperk, Czech Republic

The Vimperk plant near the Bavarian border assembles complete instruments, and also specializes in the production of cables and wirewrap parts as well as in sheet-metal work.

[Contents Overview](#)[Chapter Overview](#)[Type Index](#)[R&S Addresses](#)





Contents Overview

Chapter Overview

Type Index

R&amp;S Addresses



## Address List

## HEADQUARTERS

	Phone
	Fax
	E-mail
Rohde & Schwarz GmbH & Co. KG	+49 (89) 41 29-0
Mühlendorfstraße 15 · D-81671 München	+49 89 4129-121 64
Postfach 80 14 69 · D-81614 München	info@rohde-schwarz.com

## PLANTS

Rohde & Schwarz Messgerätebau GmbH	+49 (8331) 108-0
Riedbachstraße 58 · D-87700 Memmingen	+49 (8331) 108-11 24
Postfach 1652 · D-87686 Memmingen	info.rsdbm@rohde-schwarz.com

Rohde & Schwarz GmbH & Co. KG	+49 (9923) 857-0
Werk Teisnach	+49 (9923) 857-11 74
Kaikenrieder Straße 27 · D-94244 Teisnach	info.rsdts@rohde-schwarz.com
Postfach 1149 · D-94240 Teisnach	

Rohde & Schwarz GmbH & Co. KG	+49 (2203) 49-0
Dienstleistungszentrum Köln	+49 (2203) 49 51-229
Graf-Zeppelin-Straße 18 · D-51147 Köln	info.rsdc@rohde-schwarz.com
Postfach 98 02 60 · D-51130 Köln	service.rsdc@rohde-schwarz.com

## SUBSIDIARIES

Rohde & Schwarz Vertriebs-GmbH	+49 (89) 41 29-137 74
Mühlendorfstraße 15 · D-81671 München	+49 (89) 41 29-137 77
Postfach 80 14 69 · D-81614 München	

Rohde & Schwarz International GmbH	+49 (89) 41 29-129 84
Mühlendorfstraße 15 · D-81671 München	+49 (89) 41 29-120 50
Postfach 80 14 60 · D-81614 München	info.rusis@rohde-schwarz.com

Rohde & Schwarz Engineering and Sales GmbH	+49 (89) 41 29-137 11
Mühlendorfstraße 15 · D-81671 München	+49 (89) 41 29-137 23
Postfach 80 14 29 · D-81614 München	info.rse@rohde-schwarz.com

R&S BICK Mobilfunk GmbH	+49 (5042) 998-0
Fritz-Hahne-Str. 7 · D-31848 Bad Münder	+49 (5042) 998-105
Postfach 2062 · D-31844 Bad Münder	info.rsbeck@rohde-schwarz.com

Rohde & Schwarz FTK GmbH	+49 (30) 658 91-122
Wendenschlossstraße 168, Haus 28	+49 (30) 655 50-221
D-12557 Berlin	info.ftk@rohde-schwarz.com

Rohde & Schwarz SIT GmbH	+49 (30) 658 84-0
Agastastraße 3	+49 (30) 658 84-183
D-12489 Berlin	info.sit@rohde-schwarz.com

R&S Systems GmbH	+49 (2203) 49-5 23 25
Graf-Zeppelin-Straße 18	+49 (2203) 49-5 23 36
D-51147 Köln	info.rssys@rohde-schwarz.com

## ADDRESSES WORLDWIDE

<b>Algeria</b>	Rohde & Schwarz	+213 (21) 48 20 18
	Bureau d'Alger	+213 (21) 69 46 08
	5B Place de Laperrine	
	16035 Hydra-Alger	

**Antilles (Neth.)** see Mexico

<b>Argentina</b>	Precision Electronica S.R.L.	+541 (14) 331 10 67
	Av. Pde Julio A. Roca 710 - 6° Piso	+541 (14) 334 51 11
	1067 Buenos Aires	alberto.lombardi@prec-elec.com.ar

<b>Australia</b>	Rohde & Schwarz (Australia) Pty. Ltd.	+61 (2) 88 45 41 00
	Sales Support	+61 (2) 96 38 39 88
	Unit 6	sales@rsa.us.rohde-schwarz.com
	2-8 South Street	
	Rydalmere, N.S.W. 2116	

<b>Austria</b>	Rohde & Schwarz-Österreich Ges.m.b.H.	+43 (1) 602 61 41-0
	Am Europlatz 3	+43 (1) 602 61 41-14
	Gebäude B	rs-austria@rsoc.rohde-schwarz.com
	1120 Wien	

<b>Azerbaijan</b>	Rohde & Schwarz Azerbaijan	+994 (12) 93 31 38
	Liaison Office Baku	+994 (12) 93 03 14
	ISR Plaza	rs-azerbaijan@rus.rohde-schwarz.com
	340 Nizami Str.	
	370000 Baku	

**Baltic Countries** see Denmark

<b>Bangladesh</b>	BIL Consortium Ltd.	+880 (2) 881 06 53
	Corporate Office	+880 (2) 882 82 91
	House-33, Road-4, Block-F	
	Banani	
	Dhaka-1213	

**Barbados** see Mexico

**Belarus** see Ukraine

<b>Belgium</b>	Rohde & Schwarz Belgium N.V.	+32 (2) 721 50 02
	Excelsiorlaan 31 Bus 1	+32 (2) 725 09 36
	1930 Zaventem	info@rsb.rohde-schwarz.com

**Belize** see Mexico

**Bermuda** see Mexico

**Bosnia-Herzegovina** see Slovenia

<b>Brazil</b>	Rohde & Schwarz Do Brasil Ltda.	+55 (11) 56 44 86 11 (general)
	Av. Alfredo Egidio de Souza Aranha n° 177,	+55 (11) 56 44 86 25 (sales)
	1° andar - Santo Amaro	+55 (11) 56 44 86 36
	04726-170 Sao Paulo - SP	sales-brazil@rsdb.rohde-schwarz.com

<b>Brunei</b>	GKL Equipment Pte Ltd.	+65 (6) 276 06 26
	#11-01 BP Tower	+65 (6) 276 06 29
	396 Alexandra Road	gkleqpt@singnet.com.sg
	Singapore 119954	

<b>Bulgaria</b>	Rohde & Schwarz	+359 (2) 96 343 34
	Representation Office Bulgaria	+359 (2) 96 321 97
	39, Fridtjof Nansen Blvd.	rs-bulgaria@rsbg.rohde-schwarz.com
	1000 Sofia	

<b>Canada</b>	Rohde & Schwarz Canada Inc.	+1 (613) 592 80 00
	555 March Rd.	+1 (613) 592 80 09
	Kanata, Ontario K2K 2M5	cgirwarnauth@rsccanada.ca

<b>Chile</b>	Dymeq Ltda.	+56 (2) 339 20 00
	Av. Larrain 6666	+56 (2) 339 20 10
	Santiago	dymeq@dymeq.com

<b>China</b>	Rohde & Schwarz China Ltd.	+86 (10) 64 31 28 28
	Representative Office Beijing	+86 (10) 64 37 98 88
	Room 602, Parkview Center	info.rschina@rsbp.rohde-schwarz.com
	2 Jiangtai Road	
	Chao Yang District	
	Beijing 100016	

	Rohde & Schwarz China Ltd.	+86 (21) 63 75 00 18
	Representative Office Shanghai	+86 (21) 63 75 91 70
	Room 807/809, Central Plaza	May.Zhu@rsbp.rohde-schwarz.com
	227 Huangpi North Road	
	Shanghai 200003	

	Rohde & Schwarz China Ltd.	+86 (20) 87 55 47 58
	Representative Office Guangzhou	+86 (20) 87 55 47 59
	Room 2903, Metro Plaza	Winnie.Lin@rsbp.rohde-schwarz.com
	183 Tian He North Road	
	Guangzhou 510075	



Contents Overview

Chapter Overview

Type Index

R&amp;S Addresses





Contents Overview

Chapter Overview

Type Index

R&amp;S Addresses



## Address List

<b>China</b>	Rohde & Schwarz China Ltd. Representative Office Chengdu Unit G, 28/F, First City Plaza 308 Shuncheng Avenue Chengdu 610017	+86 (28) 86 52 76 06 +86 (28) 86 52 76 10 sophia.chen@rsbp.rohde-schwarz.com	<b>Germany</b>	Zweigniederlassungen der Rohde & Schwarz Vertriebs-GmbH/Branch offices of Rohde & Schwarz Vertriebs-GmbH		
	Rohde & Schwarz China Ltd. Representative Office Xian Room 603, Jin Xin International No. 99 Heping Road Xian 710001	+86 (29) 87 41 53 77 +86 (29) 87 20 65 00 sherry.yu@rsbp.rohde-schwarz.com		Zweigniederlassung Nord, Geschäftsstelle Berlin Ernst-Reuter-Platz 10 · D-10587 Berlin Postfach 100620 · D-10566 Berlin	+49 (30) 34 79 48-0 +49 (30) 34 79 48 48 info.rsv@rohde-schwarz.com	
	Rohde & Schwarz China Ltd. Representative Office Shenzhen Room 1901, Central Business Building No. 88 Fuhua Yilu Futian District Shenzhen 518026	+86 (755) 82 03 11 98 +86 (755) 82 03 30 70 ingessica.lia@rsbp.rohde-schwarz.com		Zweigniederlassung Büro Bonn Josef-Wirmer-Straße 1-3 · D-53123 Bonn Postfach 140264 · D-53057 Bonn	+49 (228) 918 90-0 +49 (228) 25 50 87 info.rsv@rohde-schwarz.com	
<b>Costa Rica</b>	see Mexico			Zweigniederlassung Nord, Geschäftsstelle Hamburg Steilshooper Alle 47 · D-22309 Hamburg Postfach 60 22 40 · D-22232 Hamburg	+49 (40) 63 29 00-0 +49 (40) 630 78 70 info.rsv@rohde-schwarz.com	
<b>Croatia</b>	see Slovenia			Zweigniederlassung Mitte, Geschäftsstelle Köln Niederkasseler Straße 33 · D-51147 Köln Postfach 900 149 · D-51111 Köln	+49 (2203) 807-0 +49 (2203) 807-650 info.rsv@rohde-schwarz.com	
<b>Cuba</b>	see Mexico			Zweigniederlassung Süd, Geschäftsstelle München Mühlendorfstraße 15 · D-81671 München Postfach 80 14 69 · D-81614 München	+49 (89) 41 86 95-0 +49 (89) 40 47 64 info.rsv@rohde-schwarz.com	
<b>Cyprus</b>	Hinis Telecast Ltd. Agiou Thoma 18 Kiti Larnaca 7550	+357 (24) 42 51 78 +357 (24) 42 46 21 hinis@logos.cy.net		Zweigniederlassung Süd, Geschäftsstelle Nürnberg Donaustraße 36 D-90451 Nürnberg	+49 (911) 642 03-0 +49 (911) 642 03-33 info.rsv@rohde-schwarz.com	
<b>Czech Republic</b>	Rohde & Schwarz Praha s.r.o. Hadovka Office Park Evropská 33c 16000 Praha 6	+420 (2) 24 31 12 32 +420 (2) 24 31 70 43 office@rscz.rohde-schwarz.com		Zweigniederlassung Mitte, Geschäftsstelle Neu-Isenburg Siemensstraße 20 D-63263 Neu-Isenburg	+49 (6102) 20 07-0 +49 (6102) 20 07 12 info.rsv@rohde-schwarz.com	
<b>Denmark</b>	Rohde & Schwarz Danmark A/S Ejby Industrivej 40 2600 Glostrup	+45 (43) 43 66 99 +45 (43) 43 77 44 rsdk@rsdk.rohde-schwarz.com		<b>Ghana</b>	Kop Engineering Ltd. P.O. Box 11012 3rd Floor Akai House, Osu Accra North	+233 (21) 77 89 13 +233 (21) 701 06 20
<b>Egypt</b>	U.A.S. Universal Advanced Systems 31 Manshiet El-Bakry Street Heliopolis 11341 Cairo	+20 (2) 455 67 44 +20 (2) 256 17 40 an_uas@link.net		<b>Greece</b>	Mercury S.A. 6, Loukianou Str. 10675 Athens	+302 (10) 722 92 13 +302 (10) 721 51 98 mercury@hol.gr
<b>El Salvador</b>	see Mexico			<b>Guatemala</b>	see Mexico	
<b>Estonia</b>	Rohde & Schwarz Danmark A/S Estonian Branch Office Narva mnt. 13 10151 Tallinn	+372 (6) 14 31 23 +372 (6) 14 31 21 estonia@rsdk.rohde-schwarz.com		<b>Guiana</b>	see Mexico	
<b>Finland</b>	R&S Finland Oy Taivaltie 5 FIN-01610 Vantaa	+358-207-600 400 +358-207-600 417 www.rohde-schwarz.fi		<b>Haiti</b>	see Mexico	
<b>France</b>	Rohde & Schwarz France Immeuble "Le Newton" 9-11, rue Jeanne Braconnier 92366 Meudon La Forêt Cédex	+33 (1) 41 36 10 00 +33 (1) 41 36 11 73 contact@rsf.rohde-schwarz.com		<b>Honduras</b>	see Mexico	
	Subsidiary Rennes 37 Rue du Bignon Bât. A F-35510 Cesson Sevigne	+33 (2) 99 51 97 00 +33 (2) 99 51 98 77		<b>Hong Kong</b>	Electronic Scientific Engineering 9/F North Somerset House Taikoo Place 979 King's Road, Quarry Bay Hong Kong	+852 (25) 07 03 33 +852 (25) 07 09 25 stephenchau@ese.com.hk
	Subsidiary Toulouse Technoparc 3 B.P. 501 F-31674 Labège Cédex	+33 (5) 61 39 10 69 +33 (5) 61 39 99 10		<b>Hungary</b>	Rohde & Schwarz Budapesti Iroda Váci út 169 1138 Budapest	+36 (1) 412 44 60 +36 (1) 412 44 61 rs-hungary@rshu.rohde-schwarz.com
				<b>Iceland</b>	see Denmark	
				<b>India</b>	Rohde & Schwarz India Pvt. Ltd. 244, Okhla Industrial Estate Phase - III New Delhi 110 020	+91 (11) 26 32 63 81 +91 (11) 26 32 63 73 sales@rsindia.rohde-schwarz.com



Contents Overview

Chapter Overview

Type Index

R&amp;S Addresses





Contents Overview

Chapter Overview

Type Index

R&amp;S Addresses



## Address List

<b>India</b>	Rohde & Schwarz India Pvt. Ltd. Bangalore Office No. 24, Service Road, Domlur 2nd Stage Extension Bangalore - 560 071	+91 (80) 535 23 62 +91 (80) 535 03 61 rsindiab@rsnl.net	<b>Jordan</b>	Jordan Crown Engineering & Trading Co. Jabal Amman, Second Circle Youssef Ezzideen Street P.O.Box 830414 Amman, 11183	+962 (6) 462 17 29 +962 (6) 465 96 72 jocrown@go.com.jo
	Rohde & Schwarz India Pvt. Ltd. Hyderabad Office 302 & 303, Millenium Centre 6-3-1099/1100, Somajiguda Hyderabad - 500 016	+91 (40) 23 32 24 16 +91 (40) 23 32 27 32 rsindiah@nd2.dot.net.in	<b>Kazakhstan</b>	Rohde & Schwarz Kazakhstan Representative Office Almaty Pl. Respubliki 15 480013 Almaty	+7 (32) 72 663 55 55 +7 (32) 72 63 46 33 rs-kazakhstan@rsd-rohde-schwarz.com
	Rohde & Schwarz India Pvt. Ltd. Mumbai Office B-603, Remi Bizcourt, Shah Industrial Estate, Off Veera Desai Road Andheri West Mumbai - 400 058	+91 (22) 26 30 18 10 +91 (22) 26 73 20 81 rsindiam@rsnl.net	<b>Kenya</b>	Excel Enterprises Ltd Dunga Road P.O.Box 42 788 Nairobi	+254 (2) 55 80 88 +254 (2) 54 46 79
<b>Indonesia</b>	PT Rohde & Schwarz Indonesia Graha Paramita 5th Floor Jln. Denpasar Raya Blok D-2 Jakarta 12940	+62 (21) 252 36 08 +62 (21) 252 36 07 sales@rsbj.rohde-schwarz.com services@rsbj.rohde-schwarz.com	<b>Korea</b>	Rohde & Schwarz Korea Ltd. 83-29 Nonhyun-Dong, Kangnam-Ku Seoul 135-010	+82 (2) 34 85 19 00 +82 (2) 547 43 00 sales@rskor.rohde-schwarz.com service@rskor.rohde-schwarz.com
<b>Iran</b>	Rohde & Schwarz Iran Groundfloor No. 1, 14th Street Khaled Eslamboli (Vozara) Ave. 15117 Tehran	+98 (21) 872 42 96 +98 (21) 871 90 12 alfred.korff@rsd.rohde-schwarz.com	<b>Kuwait</b>	Group Five Trading & Contracting Co. Mezzanine Floor Al-Bana Towers Ahmad Al Jaber Street Sharq	+965 (244) 91 72/73/74 +965 (244) 95 28 jk_agarwal@yahoo.com
<b>Ireland</b>	see United Kingdom		<b>Latvia</b>	Rohde & Schwarz Danmark A/S Latvian Branch Office Merkela iela 21-301 1050 Riga	+371 (7) 50 23 55 +371 (7) 50 23 60 latvia@rsdk.rohde-schwarz.com
<b>Israel</b>	Eastronics Ltd. Measurement Products 11 Rozanis St. P.O.Box 39300 Tel Aviv 61392	+972 (3) 645 87 77 +972 (3) 645 86 66 david_hasky@easx.co.il	<b>Lebanon</b>	Rohde & Schwarz Liaison Office Riyadh P.O.Box 361 Riyadh 11411	+966 (1) 465 64 28 Ext. 303 +966 (1) 465 64 28 Ext. 229 chris.porzky@rsd.rohde-schwarz.com
	J.M. Moss (Engineering) Ltd. Communications Products 9 Oded Street P.O.Box 967 52109 Ramat Gan	+972 (3) 631 20 57 +972 (3) 631 40 58 jmoss@zahav.net.il		Netcom P.O.Box 55199 Op. Ex-Presidential Palace Horch Tabet Beirut	+961 (1) 48 69 99 +961 (1) 49 05 11 tohme.sayar@netcomm.tv
<b>Italy</b>	Rohde & Schwarz Italia S.p.a. Centro Direzionale Lombardo Via Roma 108 20060 Cassina de Pecchi (MI)	+39 (02) 95 70 42 03 +39 (02) 95 30 27 72 rsi.info@rsi.rohde-schwarz.com	<b>Liechtenstein</b>	see Switzerland	
	Rohde & Schwarz Italia S.p.a. Via Tiburtina 1182 00156 Roma	+39 (06) 41 59 82 18 +39 (06) 41 59 82 70 rsi.info@rsi.rohde-schwarz.com	<b>Lithuania</b>	Rohde & Schwarz Danmark A/S Lithuanian Office Lukiskiu 5-228 2600 Vilnius	+370 (2) 22 46 62 +370 (2) 22 46 62 lithuania@rsdk.rohde-schwarz.com
<b>Jamaica</b>	see Mexico		<b>Luxembourg</b>	see Belgium	
<b>Japan</b>	Rohde & Schwarz Japan K.K. Tokyo Office 711Bldg., Room 501 7-11-18 Nishi-Shinjuku Shinjuku-ku Tokyo 160-0023	+81 (3) 59 25 12 88 +81 (3) 59 25 12 90 scj.support@rsjp.rohde-schwarz.com	<b>Macedonia</b>	see Slovenia	
	Rohde & Schwarz Japan K.K. Shin-Yokohama Office KM Daiichi Bldg., 8F 2-13-13 Kouhoku-ku Yokohama-shi Kanagawa 222-0033	+81 (4) 54 77 35 70	<b>Malaysia</b>	Dagang Teknik Sdn. Bhd. No. 9, Jalan SS 4D/2 Selangor Darul Ehsan 47301 Petaling Jaya	+60 (3) 27 03 55 68 +60 (3) 27 03 34 39 maryanne@danik.com.my
	Rohde & Schwarz Japan K.K. Osaka Office TEK Dai 2 Bldg., 8F 1-13-20 Esaka-shi Suita-shi Osaka-fu 564-0063	+81 (6) 63 10 96 51	<b>Malta</b>	Tektraco International Technology Ltd. 121, B'Kara Road San Gwann SGN 08	+356 (21) 37 43 00 or 37 80 88 +356 (21) 37 66 67 sales@tektraco.com
			<b>Mexico</b>	Rohde & Schwarz de Mexico S. de R.L. de C.V. German Centre Oficina 4-2-2 Av. Santa Fé 170 Col. Lomas de Santa Fé 01210 Mexico D.F.	+52 (55) 85 03 99 13 +52 (55) 85 03 99 16 latinoamerica@rsd.rohde-schwarz.com
			<b>Moldava</b>	see Romania	



Contents Overview

Chapter Overview

Type Index

R&amp;S Addresses





Contents Overview

Chapter Overview

Type Index

R&amp;S Addresses



## Address List

<b>Nepal</b>	CTC Pvt. Ltd. Hattisar, Post Box No. 660 Kathmandu	+977 (1) 443 48 95 +977 (1) 443 49 37 ictc@mos.com.np	<b>Saudi Arabia</b>	Rohde & Schwarz International GmbH - Liaison Office Riyadh c/o Haji Abdullah Alireza Co. Ltd. chris.porzky@rsd.rohde-schwarz.com P.O.Box 361 Riyadh 11411	+966 (1) 293 2035 +966 (1) 466 1657
<b>Netherlands</b>	Rohde & Schwarz Nederland B.V. Perkinsbaan 1 3439 ND Nieuwegein	+31 (30) 600 17 00 +31 (30) 600 17 99 info@rsn.rohde-schwarz.com		Genotec Haji Abdullah Alireza & Co. Ltd. P.O.Box 43054 Riyadh	+966 (1) 293 20 35 +966 (1) 466 16 57 akanbar@genotec.com.sa
<b>New Zealand</b>	Nichecom 1 Lincoln Ave. Tawa, Wellington	+64 (4) 232 32 33 +64 (4) 232 32 30 rob@nichecom.co.nz	<b>Serbia-Montenegro</b>	Rohde & Schwarz, Representative Office Belgrade Tose Jovanovica 7 11030 Beograd	+381 (11) 305 50 25 +381 (11) 305 50 24 petar.pavasovic@rscs.rohde-schwarz.com
<b>Nicaragua</b>	see Mexico		<b>Singapore</b>	Rohde & Schwarz Systems & Communications Asia Pte Ltd 1 Kaki Bukit View #04-05/07 Techview Singapore 415 941	+65 68 46 37 10 +65 68 46 00 29 rsca@rssg.rohde-schwarz.com
<b>Nigeria</b>	Ferrostaal Abuja Plot 3323, Barada Close P.O.Box 8513, Wuse Off Amazon Street Maitama, Abuja	+234 (9) 413 52 51 +234 (9) 413 52 50 fsabuja@rosecom.net	<b>Slovak Republic</b>	Speciálne systémy a software, a.s. Svrčia ul. 841 04 Bratislava	+421 (2) 65 42 24 88 +421 (2) 65 42 07 68 3s@special.sk
<b>Norway</b>	ROHDE & SCHWARZ NORGE AS Enebakkeveien 302 B 1188 Oslo	+47 (23) 38 66 00 +47 (23) 38 66 01 firmapost@rsnor.rohde-schwarz.com	<b>Slovenia</b>	Rohde & Schwarz Representative Office Ljubljana Tbilisjska 89 1000 Ljubljana	+386 (1) 423 46 51 +386 (1) 423 46 11 rs-slovenia@rssi.rohde-schwarz.com
<b>Oman</b>	Mustafa Sultan Science & Industry Co.LLC. Test & Measurement Products Way No. 3503 Building No. 241 Postal Code 112 Al Khuwair, Muscat	+968 63 60 00 +968 60 70 66 m-aziz@mustafasultan.com	<b>South Africa</b>	Protea Data Systems (Pty.) Ltd. Communications and Measurement Division Private Bag X19 Bramley 2018	+27 (11) 719 57 00 +27 (11) 786 58 91 unicm@protea.co.za
<b>Pakistan</b>	Siemens Pakistan 23, West Jinnah Avenue Islamabad	+92 (51) 227 22 00 +92 (51) 227 54 98 reza.bokhary@siemens.com.pk		Protea Data Systems (Pty.) Ltd. Cape Town Branch Unit G9, Centurion Business Park Bosmandam Road Milnerton Cape Town, 7441	+27 (21) 555 36 32 +27 (21) 555 42 67 unicm@protea.co.za
<b>Panama</b>	see Mexico		<b>Spain</b>	Rohde & Schwarz Espana S.A. Salcedo, 11 28034 Madrid	+34 (91) 334 10 70 +34 (91) 729 05 06 rses@rses.rohde-schwarz.com
<b>Papua New Guinea</b>	see Australia			Rohde & Schwarz Espana S.A. Av. Princep d'Astúries, 66 08012 Barcelona	+34 (93) 415 15 68 +34 (93) 237 49 95 bcn@rses.rohde-schwarz.com
<b>Paraguay</b>	see Argentina		<b>Sri Lanka</b>	Dynatel Communications (PTE) Ltd. 451/A Kandy Road Kelaniya	+94 (112) 90 80 01 +94 (112) 91 04 69 69 dynatel@dynanet.lk
<b>Philippines</b>	Rohde & Schwarz (Philippines) Ltd. Unit 2301 PBCom Tower 6795 Ayala Ave. cor. Herrera Sts. Makati City	+63 (2) 753 14 44 +63 (2) 753 14 56	<b>Sudan</b>	SolarMan Co. Ltd. P.O.Box 11 545 North of Fraouq Cementry 6/7/9 Bldg. 16 Karthoum	+249 (11) 47 31 08 +249 (11) 47 31 38 solarman29@hotmail.com
<b>Poland</b>	Rohde & Schwarz SP.z o.o. Przedstawicielstwo w Polsce ul. Stawki 2, Pietro 28 00-193 Warszawa	+48 (22) 860 64 94 +48 (22) 860 64 99 rs-poland@rspl.rohde-schwarz.com	<b>Sweden</b>	Rohde & Schwarz Sverige AB Flygfältsgatan 15 128 30 Skarpnäck	+46 (8) 605 19 00 +46 (8) 605 19 80 info@rss.rohde-schwarz.com
<b>Portugal</b>	Rohde & Schwarz Portugal, Lda. Alameda Antonio Sergio 7-R/C - Sala A 2795-023 Linda-a-Velha	+351 (21) 415 57 00 +351 (21) 415 57 10 info@rspt.rohde-schwarz.com	<b>Switzerland</b>	Roschi Rohde & Schwarz AG Mühlestr. 7 3063 Ittigen	+41 (31) 922 15 22 +41 (31) 921 81 01 support@roschi.rohde-schwarz.com
<b>Republic Dominican</b>	see Mexico		<b>Syria</b>	Electro Scientific Office Baghdad Street Dawara Clinical Lab. Bldg P.O.Box 8162 Damascus	+963 (11) 231 59 74 +963 (11) 231 88 75 memo@hamshointl.com
<b>Romania</b>	Rohde & Schwarz Representative Office Bucharest Str. Uranus 98 Sc. 2, Et. 5, Ap. 36 76102 Bucuresti, Sector 5	+40 (21) 410 68 46 +40 (21) 411 20 13 rs-romania@rsro.rohde-schwarz.com			
<b>Russian Federation</b>	Rohde & Schwarz Representative Office Moscow 119180, Yakimanskaya nab., 2 Moscow	+7 (095) 745 88 50 to 53 +7 (095) 745 88 54 rs-russia@rsru.rohde-schwarz.com			



Contents Overview

Chapter Overview

Type Index

R&amp;S Addresses





Contents Overview

Chapter Overview

Type Index

R&amp;S Addresses



## Address List

<b>Taiwan</b>	Rohde & Schwarz Taiwan (Pvt.) Ltd. Floor 14, No. 13, Sec. 2, Pei-Tou Road Taipei 112	+886 (2) 28 93 10 88 +886 (2) 28 91 72 60 celine.tu@rstw.rohde-schwarz.com	<b>Uruguay</b>	Aeromarine S.A. Cerro Largo 1497 11200 Montevideo	+598 (2) 400 39 62 +598 (2) 401 85 97 sales@aeromarine.com.uy
<b>Tanzania</b>	SSTL Group P.O. Box 7512 Dunga Street Plot 343/345 Dar Es Salaam	+255 (22) 276 00 37 +255 (22) 276 02 93 sstl@ud.co.tz	<b>USA</b>	Rohde & Schwarz, Inc. Eastern Regional Office (US Headquarters) 8661A Robert Fulton Drive Columbia, MD 21046-2265	+1 (410) 910 78 00 +1 (410) 910 78 01 Toll free: 1-888-Test-RSA (1-888-837-8772) info@rsa.rohde-schwarz.com www.rohde-schwarz.com/usa
<b>Thailand</b>	Schmidt Electronics (Thailand) Ltd. 202 Le Concorde Tower, 23rd Floor, Ratchadaphisek Rd., Huay-kwang, Bangkok 10320 Thailand	+(66) 2694-1470-5 +(66) 2694-1476 kamthoninthuyot@ schmidttailand.com		Rohde & Schwarz, Inc. Central Regional Office Systems EMI Products 8080 Tristar Drive, Suite 120 Irving, TX 75063	+1 (469) 713 53 00 +1 (469) 713 53 01 info@rsa.rohde-schwarz.com www.rohde-schwarz.com/usa
<b>Trinidad &amp; Tobago</b>	see Mexico			Rohde & Schwarz, Inc. R&D and Application Support 8905 SW Nimbus Ave Suite 240 Beaverton, OR 97008	+1 (503) 403 47 00 +1 (503) 403 47 01 info@rsa.rohde-schwarz.com www.rohde-schwarz.com/usa
<b>Tunisia</b>	Teletek 71, Rue Alain Savary Residence Alain Savary (C64) Cit� el Khadra 1003 Tunis	+216 (71) 77 33 88 teletek@gnet.tn		Rohde & Schwarz, Inc. Western Regional Office 7700 Irvine Center Drive Suite 100 Irvine, CA 92618	+1 (949) 885 70 00 +1 (949) 885 70 1 info@rsa.rohde-schwarz.com www.rohde-schwarz.com/usa
<b>Turkey</b>	Rohde & Schwarz International GmbH Liaison Office Istanbul Bagdat Cad. 191/3, Arda Apt. B-Blok 81030 Selamicesme-Istanbul	+90 (216) 385 19 17 +90 (216) 385 19 18 rsturk@superonline.com		Rohde & Schwarz, Inc. Service & Calibration Center 8661A Robert Fulton Drive Columbia, MD 21046-2265	+1 (410) 910 50 02 +1 (410) 910 79 31 service.rsa@rsa.rohde-schwarz.com
<b>Ukraine</b>	Rohde & Schwarz Representative Office Kiev 4, Patris Loumoumba ul 01042 Kiev	+38 (044) 268 60 55 +38 (044) 268 83 64 rsbkiev@public.ua.net	<b>Vietnam</b>	Schmidt Vietnam Co. (H.K.) Ltd., Representative Office Hanoi Intern. Technology Centre 8/F, HITC Building 239 Xuan Thuy Road Cau Giay, Tu Liem Hanoi	+84 (4) 834 61 86 +84 (4) 834 61 88 svnhn@schmidtgrou.com
<b>United Arab Emirates</b>	Rohde & Schwarz International GmbH Liaison Office Middle East Vertrieb P.O. Box 31156 Abu Dhabi	+971 (2) 6335 670 +971 (2) 6335 671 michael.rogler@rsd.rsd.de	<b>West Indies</b>	see Mexico	
	Rohde & Schwarz Bick Mobile Communication P.O.Box 17466 Dubai	+971 (4) 883 71 35 +971 (4) 883 71 36			
	Rohde & Schwarz Emirates L.L.C. ESNAAD Premisses at Mussafah, P.O.Box 31156 Abu Dhabi	+971 (2) 55 49 411 +971 (2) 55 49 433 rsuaeam@emirates.net.ae			
<b>United Kingdom</b>	Rohde & Schwarz UK Ltd. Ancells Business Park Fleet Hampshire GU 51 2UZ England	+44 (1252) 81 88 88 (sales) +44 (1252) 81 88 18 (service) +44 (1252) 81 14 47 sales@rsuk.rohde-schwarz.com			
<b>United Kingdom</b>	Rohde & Schwarz UK Ltd. 3000 Manchester Business Park Aviator Way Manchester M22 5TG	+44 (870) 735 16 42 +44 (1252) 81 14 77 sales@rsuk.rohde-schwarz.com			



Contents Overview

Chapter Overview

Type Index

R&amp;S Addresses





Contents Overview

Chapter Overview

Type Index

R&amp;S Addresses



## Type/Data Sheet Index

Type	Designation	Data Sheet	Article in News from R&S	Page
<b>A</b>				
R&S® ABFS	Baseband Fading Simulator	PD 0757.5466	163	268
R&S® AM300	<b>new!</b> Dual-Channel Arbitrary/Function Generator	PD 0758.0897	181	266
R&S® AM524	Active Antenna System	PD 0756.9974	136	88
R&S® AMIQ 04	I/Q Modulation Generators	PD 0757.3970	158, 162, 166, 169, 171, 173	261
<b>C</b>				
R&S® CBT/CBT32	<b>new!</b> Bluetooth® Testers	PD 0758.1287	–	18
R&S® CMD57	GSM Base Station Testers	PD 0757.1231	146, 151, 152, 161	21
R&S® CMD60	DECT Testers	PD 0757.2596	149, 152	37
R&S® CMS50/54	Radiocommunication Service Monitors	PD 0757.1031	127, 129, 130, 134, 136	46
R&S® CMU200	Universal Radio Communication Tester	PD 0757.4318	169, 170, 171, 172, 173, 175	6
R&S® CMU300	Universal Radio Communication Tester	PD 0758.0000	170, 171, 175	14
R&S® CMU-Z10/-Z11/-Z12/-Z13	Antenna Coupler, RF Shielding Cover, <i>Bluetooth</i> Antenna, USB feed-through	PD 0757.7352	175	52
R&S® CompactTSVP	<b>new!</b> Open Test Platform	PD 0758.0480	–	327
R&S® CRTU-G	Test set for protocol verification GSM	PD 0757.6056	171	25
R&S® CRTU-S	Protocol Slave/Data Unit	–	–	28
R&S® CRTU-VT	3G Virtual Protocol Test System	PD 0757.7781	175	36
R&S® CRTU-W	Protocol Tester	PD 0757.7252	175	30
R&S® CTS55/60/65	GSM Digital Radio Testers	PD 0757.2509	147, 152, 158, 159, 162	34
<b>D</b>				
R&S® DNF	Attenuators	PD 0756.3860	–	413
R&S® DPS, R&S® DPSP	RF Step Attenuators	PD 0756.4889	84, 96	410
R&S® DV-HDTV	HDTV Sequences	PD 0757.6979	–	113
R&S® DV-TCM	Test Card M Sequences	PD 0757.7369	–	115
R&S® DVATM	<b>new!</b> MPEG-2/ATM Test Set	–	174	138
R&S® DVG	MPEG2 Measurement Generator	PD 0757.2738	152, 154, 155, 173	116
R&S® DVG-B1	Stream Combiner	PD 0757.3611	–	118
R&S® DVM100/120	<b>new!</b> MPEG-2 Monitoring System	PD 0757.8513	179	133
R&S® DVM400	<b>new!</b> Digital Video Measurement System	PD 0757.0397	182	135
R&S® DVMD	MPEG-2 Measurement Decoder	PD 0758.1406	152, 154, 155, 161	127
R&S® DVMD-B1	Stream Explorer	PD 0757.3628	158	131
R&S® DVQ	Digital Video Quality Analyzer	PD 0757.4601	163	120
R&S® DVQM	Multichannel Digital Video Quality Analyzer	PD 0757.6510	169	123
R&S® DVQ-B1	Quality Explorer™	PD 0757.5450	163	122
R&S® DVRG	DTV Recorder Generator	PD 0758.1006	173	110
R&S® DVRM	MPEG2 Realtime Monitor	PD 0757.5566	167	129
R&S® DVS	Power Splitter/Combiner	PD 0756.3801	–	415
R&S® DVU4	Four-Port Junction Box	PD 0756.3801	–	415



Contents Overview

Chapter Overview

Type Index

R&amp;S Addresses



[Contents Overview](#)[Chapter Overview](#)[Type Index](#)[R&S Addresses](#)

## Type/Data Sheet Index

Type	Designation	Data Sheet	Article in News from R&S	Page
<b>E</b>				
R&S® E-Line	Extreme Temperature Tester	PD 0757.7181	–	329
R&S® EB200	Miniport Receiver	PD 0757.3728	158, 170, 171	75
R&S® EFA	TV Test Receiver Family	PD 0757.2421	152, 157, 164, 167, 172, 173	142
R&S® EFA-K1	<b>new!</b> Measurement Software EFA-SCAN	PD 0758.0416	179	148
R&S® EFL 100	<b>new!</b> Portable SAT/TV/FM Test Receiver	PD 0758.0551	179	150
R&S® EMC32	EMC Measurement Software	PD 0757.6779	172	80
R&S® EMC32-E+	<b>new!</b> EMI Measurement Software	PD 0758.1270	179	82
R&S® EMON-K1	CAN-Bus Monitoring	PD 0757.6604	–	372
R&S® EMS-K1	EMS Software	PD 0757.1654	148, 157	370
R&S® ENV216	<b>new!</b> Two-Line V-Network	PD 0757.8265	–	100
R&S® ENV4200	200-A Four-Line V-Network	PD 0757.3428	158	101
R&S® ENY22/ENY41	Coupling Networks	PD 0757.4953	–	102
R&S® ES-K1	EMI Software	PD 0757.0406	142, 146	78
R&S® ESCI	<b>new!</b> EMI Test Receiver	PD 0758.1558	182	66
R&S® ESH2-Z2	Active Probe	PD 0756.4320	–	107
R&S® ESH2-Z3	Passive Probe	PD 0756.4320	–	107
R&S® ESH2-Z5	V-Network	PD 0756.4895	–	99
R&S® ESH2-Z11	Attenuator	PD 0756.4320	–	106
R&S® ESH3-Z2	Pulse Limiter	PD 0756.4320	–	106
R&S® ESH3-Z6	V-Network	PD 0756.4908	117	99
R&S® ESIB-B2	Internal Preamplifier	PD 0757.7000	–	74
R&S® ESIB	EMI Test Receiver	PD 0757.4576	162, 168, 173	70
R&S® ESPI, R&S® ESPI-K50	Test Receiver	PD 0757.6540	171, 175	62
R&S® ESV-Z1	VHF Current Probe	PD 0756.4320	–	106
R&S® ESxS-K1	EMI Software	PD 0757.1848	151	84
R&S® EVS200	VOR/ILS Receiver/Analyzer	–	–	281
R&S® EZ-12	Antenna Impedance Converter	PD 0757.5289	134	104
R&S® EZ-17	Current Probe	PD 0756.9539	148	104
R&S® EZ-24	Ferrite Clamp	PD 0756.5085	–	85
R&S® EZ-25	150 kHz Highpass	PD 0757.4976	–	105
<b>F</b>				
R&S® FMA, R&S® FMB	Modulation Analyzers	PD 0756.9300	136, 138, 144	283
R&S® FMAB	Modulation Analyzer	PD 0758.0797	134	283
R&S® FMAS	Selective Modulation Analyzer	PD 0757.0912	144	283
R&S® FMAV	Modulation Analyzer	PD 0756.9839	138	283
R&S® FMA-B4	AM/FM Calibrator/AF Generator	PD 0756.9951	139	283
R&S® FMA-B8	AF Analyzer/DSP Unit	PD 0757.0635	141	283
R&S® FMA-B9	RF/IF Section	PD 0757.1077	134	283

[Contents Overview](#)[Chapter Overview](#)[Type Index](#)[R&S Addresses](#)

[Contents Overview](#)[Chapter Overview](#)[Type Index](#)[R&S Addresses](#)

## Type/Data Sheet Index

Type	Designation	Data Sheet	Article in News from R&S	Page
R&S® FS-K3	Noise Measurement Software	PD 0757.2380	167	188
R&S® FS-K4	Phase Noise Measurement Software	PD 0757.6727	163	190
R&S® FS-K5	GSM/EDGE Application Firmware	PD 0757.6185	170	195
R&S® FS-K7	FM Measurement Demodulator	PD 0757.6685	–	191
R&S® FS-K8	<i>Bluetooth</i> Application Firmware	PD 0757.7730	–	205
R&S® FS-K30	<b>new!</b> Application Firmware for Noise Figure and Gain Measurements for R&S®FSP/FSU/FSQ	PD 0758.0839	–	189
R&S® FS-K72/-K73	WCDMA 3GPP Application Firmware	PD 0757.7246	–	197
R&S® FS-K76/-K77	<b>new!</b> TD-SCDMA Test Application Firmware	PD 0758.0880	181	199
R&S® FS-K82, R&S® FS-K84	<b>new!</b> cdma2000 Base Station Test Application Firmware, 1xEV-DO Base Station Test Application Firmware	PD 0757.7675	–	201
R&S® FS-K83	<b>new!</b> cdma2000/1xEV-DV Mobile Station Test Application Firmware	PD 0758.0697	–	203
R&S® FS-Z60/-Z75 R&S® FS-Z90/-Z110	Harmonic Mixers	PD 0757.6310	–	211
R&S® FS300	<b>new!</b> Spectrum Analyzer	PD 0758.0297	177	174
R&S® FSH3	Handheld Spectrum Analyzer	PD 0758.0174	175	172
R&S® FSP	Spectrum Analyzers	PD 0758.1206	166, 168, 170, 172, 175	176
R&S® FSP-B6	TV Trigger/RF Power Trigger	PD 0757.6433	–	210
R&S® FSP-K90	<b>new!</b> WLAN 802.11a Application Firmware	PD 0758.0916	180	207
R&S® FSQ	Signal Analyzers	PD 0758.0945	174	184
R&S® FSQ-K70	<b>new!</b> Option Vector Signal Analyzer	PD 0757.8307	181	193
R&S® FSQ-K90, R&S® FSQ-K91	<b>new!</b> WLAN 802.11a Application Firmware, WLAN 802.11a/b/g/j Application Firmware	PD 0758.0200, PD 0758.1435	180	208
R&S® FSU	Spectrum Analyzers	PD 0758.0016	170, 171, 174, 175	180
<b>H</b>				
R&S® HE202/302	Active Receiving Dipoles	PD 0757.0429	139	93
R&S® HF906	Double-Ridged Waveguide Horn Antenna	–	–	97
R&S® HFH2-Z1/-Z2/-Z4/-Z6	HF Antennas	PD 0756.4320	–	94
R&S® HK116/HL223/023A1, R&S® HL 040/046/050	VHF, UHF and SHF Antennas	PD 0756.9380	–	95
R&S® HL562	ULTRALOG	–	–	96
R&S® HFU2-Z4/-Z5	RF Cables	PD 0756.4320	–	107
R&S® HM020	Triple Loop Antenna	PD 0756.9439	136	87
R&S® HM525	H-Field Test Antenna	–	–	88
R&S® HZ-9	Power Supply	PD 0756.4320	–	94
R&S® HUF-Z1, R&S® HFU-Z, R&S® HZ-1	Broadband Dipole, Mast and Tripod	PD 0756.4320	–	98
R&S® HZ-3/-4	Feeder Cables	PD 0756.4320	–	107
R&S® HZ-10	Shielded, Calibrated Magnetic Field Pickup Coil	PD 0757.0458	–	89
R&S® HZ-11	Probe Set (E and H Field)	PD 0757.0158	141	90
R&S® HZ-14	Probe Set (E and H Field)	PD 0757.0164	141	90

[Contents Overview](#)[Chapter Overview](#)[Type Index](#)[R&S Addresses](#)





Contents Overview

Chapter Overview

Type Index

R&amp;S Addresses



## Type/Data Sheet Index

Type	Designation	Data Sheet	Article in News from R&S	Page
R&S® HZ-12/-13	Precision Halfwave Dipole Sets	PD 0757.0387	144	92
<b>M</b>				
R&S® MDS-21/-22	Absorbing Clamps	PD 0756.5085	46, 72, 147	85
<b>N</b>				
R&S® NAP-Z...	Power Sensors	PD 0757.2396	–	301
R&S® NAS, NAS-Z...	Power Reflection Meter, Power Sensors	PD 0756.6617	134, 139, 145	305
R&S® NG/A/AS/B/BI/K/M	Single Power Supplies	–	–	382
R&S® NGC	Power Supplies with High Efficiency	–	–	388
R&S® NGL, R&S® NGMD, R&S® NGT	Dual and Triple Power Supplies	–	–	382
R&S® NGM02	Dual-Channel Analyzer/Power Supply	PD 0757.6579	171	400
R&S® NGPE40/40	Programmable Power Supplies	–	113	395
R&S® NGPE 35/40, R&S® NGPE 70/20	<b>new!</b> Programmable DC Power Supplies	–	–	397
R&S® NGPS32	Programmable Voltage Source	–	–	399
R&S® NGPT7/18/35	Programmable Triple Power Supplies	–	–	403
R&S® NGPU	Programmable Power Supplies	–	77	390
R&S® NGPV	Programmable Power Supplies	–	99	391
R&S® NGPX	Programmable Power Supplies	–	–	393
R&S® NGRE	Power Supplies with High Output Power	–	–	388
R&S® NGRU	Precision Power Supplies	–	100	385
R&S® NGSM32	DC Power Supply/Arbitrary Generator	PD 0757.1148	147	405
R&S® NRP	Power Meter	PD 0757.7023	174	290
R&S® NRP-Zx	Power Sensors	PD 0757.7023	174	290
R&S® NRT, NRT-Z	Power Reflection Meter, Power Sensors	PD 0757.2396	153, 161	301
R&S® NRV-Z...	Power Sensors	PD 0756.9797	133, 139, 145, 153	298
R&S® NRV-Z31	Peak Power Sensor	PD 0757.0841	145	298
R&S® NRV-Z33	Peak Power Sensor	PD 0757.2344	148	298
R&S® NRV-Z53/-Z54	Thermocouple Power Sensors	PD 0757.0612	145	298
R&S® NRVD	Dual-Channel Power Meter	PD 0756.3176	137	296
R&S® NRVS	Power Meter	PD 0756.3182	137	294
<b>P</b>				
R&S® PSL3	<b>new!</b> Industrial Controller	PD 0758.0216	179	376
R&S® PSP7	Portable Industrial Controllers	PD 0757.2515	153	374
R&S® PSU	RF Relay Matrix	PD 0756.4166	80	412
R&S® PTW15	DECT Signalling Test Unit	PD 0757.5020	162	40
R&S® PTW70	<b>new!</b> WLAN Protocol Tester	PD 0758.0268	–	42



Contents Overview

Chapter Overview

Type Index

R&amp;S Addresses



[Contents Overview](#)[Chapter Overview](#)[Type Index](#)[R&S Addresses](#)

## Type/Data Sheet Index

Type	Designation	Data Sheet	Article in News from R&S	Page
<b>R</b>				
R&S® RAM, R&S® RAZ	Adapters to systems of other make	PD 0756.3860	–	413
R&S® RBU, R&S® RDL, R&S® RBS	High-Power Attenuators	PD 0756.3860	–	413
R&S® RNA, R&S® RNB, R&S® RAD	Terminations, Feedthrough Terminations	PD 0756.3860	–	413
R&S® ROSEVAL	Evaluation Software TS9954	PD 0757.4082	–	350
R&S® RSG, R&S® RSP	RF Attenuators	PD 0756.4889	122, 128, 143	410
R&S® RVZ	Power Splitter	PD 0756.4714	–	413
<b>S</b>				
R&S® SAF, R&S® SFF	CCVS+Component Generator, CCVS Generator	PD 0756.9845	138, 144	152
R&S® SFM	TV Test Transmitter	PD 0757.1702	148	154
R&S® SFL	TV Test Transmitter	PD 0758.1429	172	156
R&S® SFQ	TV Test Transmitter	PD 0758.0222	162, 166, 167, 170, 171, 174	158
R&S® SGMF, R&S® SGPF, R&S® SGSF	TV Generators	PD 0756.8749	126	161
R&S® SMIQ	Vector Signal Generators	PD 0757.2438	161 163, 166, 168, 169, 171, 173	232
R&S® SMIQ03HD	Vector Signal Generator	PD 0757.7375	174	238
R&S® SM300 <b>new!</b>	RF Signal Generator	PD 0758.0180	180	249
R&S® SML	Signal Generator	PD 0757.5550	165, 169, 175	246
R&S® SMP	Microwave Signal Generators	PD 0757.0951	144, 147, 152, 157	251
R&S® SMR20/27/30/40	Microwave Signal Generators	PD 0757.4418	162, 165, 172	255
R&S® SMR50/60	Microwave Signal Generators	PD 0757.7630	174	258
R&S® SMT	Signal Generators	PD 0757.0364	142, 148, 151	244
R&S® SMU200A <b>new!</b>	Vector Signal Generator	PD 0758.0197	180	226
R&S® SMV03	Vector Signal Generator	PD 0757.7175	175	240
<b>T</b>				
R&S® TestDVD	DVD Compendium	–	176	140
R&S® TS7100/7180	Cellular Phone Production Test Platform	PD 0757.5737	169	341
R&S® TS7110 <b>new!</b>	Shielded RF Test Fixture	–	179	322
R&S® TS8950G/W	RF Test System for GSM/GPRS/EDGE Mobiles	PD 0757.6956	174	331
R&S® TS8960	Bluetooth Qualification and Conformance Test Systems	PD 0757.7300	172	334
R&S® TS8965B/8965C	RF Test Systems	–	–	335
R&S® TS9951	Portable Coverage Measurement System	–	–	339
R&S® TS9953	Test Transmitter System	PD 0757.2115	–	348
R&S® TS9954	Evaluation Software ROSEVAL	PD 0757.4082	–	350
R&S® TS9955	High-Performance Coverage Measurement System	PD 0757.2138	–	338
R&S® TS9958 ROGER	GSM Interference Analyzer	PD 0757.6079	168	345
R&S® TS9970	RF Performance Test System	PD 0757.5189	–	356
R&S® TS9975	EMI Test System	–	142	358

[Contents Overview](#)[Chapter Overview](#)[Type Index](#)[R&S Addresses](#)

[Contents Overview](#)[Chapter Overview](#)[Type Index](#)[R&S Addresses](#)

## Type/Data Sheet Index

Type	Designation	Data Sheet	Article in News from R&S	Page
R&S® TS9976	Emission Test System	PD 0757.5495	–	359
R&S® TS998xM	EUT Monitoring Systems	–	–	366
R&S® TS9980	EMS Test System	PD 0757.1525	128, 173	361
R&S® TS9981	EMS Test System	–	–	363
R&S® TS9986	EMS Test System	–	–	365
R&S® TS9994	EMS Test System	PD 0757.6591	–	367
R&S® TS-EMF	<b>new!</b> Portable System for EMF Measurements	PD 0757.8242	179, 180, 181	368
R&S® TSMU	<b>new!</b> Radio Network Analyzer	PD 0758.0474	180	353
<b>U</b>				
R&S® UAF	Video Analyzer	PD 0756.8726	128	162
R&S® UMTS PN-Scanner	Drive test equipment for network planning, design...	PD 0758.0045	–	351
R&S® UPL-B23	Coded Audio Signal Generation	PD 0757.6985	175	277
R&S® UPL	Audio Analyzers	PD 0757.2238	151, 158, 173, 175	272
R&S® UPL + R&S® UPL-B7	Test System for Hearing Aids	PD 0757.2696	–	275
R&S® UPV	<b>new!</b> Audio Analyzer	PD 0758.1306	–	279
R&S® UPZ	Audio Switcher	PD 0758.1170	–	277
R&S® URE2	RMS Voltmeter	PD 0756.8526	127, 131	313
R&S® URE3	RMS/Peak Voltmeter	PD 0756.8326	127, 131	313
R&S® URV35	Voltage, Level and Power Meter	PD 0756.9497	135	307
R&S® URV5	Millivoltmeter	PD 0756.4614	106, 116, 130, 156	308
R&S® URV55	RF Millivoltmeter	PD 0756.3453	–	309
R&S® URV5-Z...	DC Probe	PD 0756.9816	–	311
<b>V</b>				
R&S® VCA	Digital Video Component Analyzer	PD 0757.1202	145, 150	164
R&S® VCA-B11	DTL Analysis	PD 0757.1202	–	164
R&S® VCA-Z1	SWR Bridge	–	–	222
R&S® VSA	Video Measurement System	PD 0757.0464	147, 150	165
R&S® VSA-B10	TV Test Receiver Option	PD 0757.2521	–	168
<b>W</b>				
R&S® WinIQSIM	I/Q Modulation Simulation Software	PD 0758.0680	158, 162, 166, 169, 171, 173	263
<b>Z</b>				
R&S® ZRA	SWR Bridge	PD 0756.9574	–	222
R&S® ZRB2	SWR Bridge	PD 0756.4395	106	222
R&S® ZRC	SWR Bridge	PD 0757.0064	140	222
R&S® ZVB	<b>new!</b> Vector Network Analyzers	PD 0758.1529	–	213
R&S® ZVM, R&S® ZVK	Vector Network Analyzers	PD 0757.5543	–	217
R&S® ZZA-x	19" Adapters	–	–	418

[Contents Overview](#)[Chapter Overview](#)[Type Index](#)[R&S Addresses](#)